

Prof. Dr Jan Pająk
Advanced Magnetic Devices - volume 14
Validation of the Magnocraft - part 3:
Oscillatory Chambers used in UFOs

Scientific monograph, 4th edition, New Zealand, 2009, ISBN 0-9583727-4-8

Copyright © 1998 by Prof. Dr Jan Pająk.

All rights reserved. No part of this monograph may be reproduced, stored in a database or retrieval system, transmitted, or distributed in any form or by any means, electronic, mechanical, photocopying, recording, or otherwise, without the prior written permission from the author or a person legally authorized to act on his behalf. From the obligation of getting such a written permission are only released those who would like to prepare a single copy of this monograph for their personal use oriented towards the increase of their knowledge and who fulfil the condition that they will not use the copy prepared for any professional purpose or for accomplishing material gains, and also that they copy the entire monograph - including the title page, the content pages, all chapters, all illustrations, and all enclosures. Also authors of other publications can quote small excerpts from this monograph (in total not longer than 5 pages) without such a permission - but under the condition that with their quotation they provide detailed editorial data of this quotation (i.e. provide the author, title, edition, and subsection of this monograph, from which their quotation originates).

A private edition by the author. Published in New Zealand, in two language versions: English and Polish. Date of the latest update of this volume: 5 September 2009.

This monograph [1/4_E] is a scientific report from results of the author's research. For this reason parts with documentary or evidential value are presented accordingly to standards applicable for scientific publications (reports). Special attention is given to the requirement of repetitiveness, i.e. that on the basis of this monograph any professional scientist or hobby investigator who would like to verify, repeat, or extend the author's research should be able to recreate his work and arrive at very similar results and conclusions.

This monograph [1/4] is a fourth edition (augmented, updated, and reedited) of the most important scientific publication [1] by the author. The completion of this monograph was initiated in early 1997. For the first time it was published in 1998 (initially in the Polish language only). Until 2001 it was disseminated in printed copies only. The Internet dissemination of the fourth edition of it, already in two languages (Polish and English) was started in 2001. From 2001 until 2008 text and illustrations of [1/4] were offered separately via the Internet in 3 source formats (WP6, DOC, PDF). Since 2007 an altered and philosophically different version of this monograph [1/4] started to be distributed via Internet as its fifth edition [1/5]. In 2008 this [1/4] was reedited and all the illustrations were inserted into the text, so that the ready for printing monograph [1/4] could be disseminated in the handy and safe PDF format.

At the time of writing this monograph, till October 1998, address of the author of [1/4] was:

Assoc. Prof. Jan Pająk,
Faculty of Engineering, Universiti Malaysia Sarawak (UNIMAS)
94300 Kota Samarahan, Sarawak (Borneo), MALAYSIA

Since February 2001 the author's address is:

Dr Eng. Jan Pająk, P.O. Box 33250, Petone 5046, NEW ZEALAND
Home tel.(2009): +64 (4) 5694820; E-mails: janpajak@gmail.com or pajakjan@yahoo.co.nz

ABSTRACT of the volume 14 of monograph [1/4_E] "Advanced magnetic devices", ISBN 0-9583727-4-8.

Evil UFO-nauts use on Earth a wide range of various advanced vehicles and technical devices. The design and operation of most important of them is defined by the statements of the Theory of the Magnocraft and the Concept of Dipolar Gravity. Thus this design and operation are already described in chapters B to F and K to N of this monograph. Therefore this volume is only designated to disclose evidence, and thus to prove, that such propulsion systems and technical devices described previously in a theoretical manner, are really owned and used in practice by UFO-nauts.

The proving that UFO-nauts really do have, and practically utilise, various propulsion systems and technical devices described in previous parts of this monograph, introduces an entire range of consequences. The most important out of these is, that it proves also the correctness of technical ideas of these devices. This is because if a given technical device postulated in this monograph was already completed by UFO-nauts, and is currently used by them, it practically means that the completion of this device is feasible, and that it utilises the implementable principles and phenomena. Thus, it also can be constructed by us. Other benefits resulting from proving, that devices postulated by the Theory of the Magnocraft and by the Concept of Dipolar Gravity that are described in this monograph, are already build and used by UFO-nauts, include amongst others: (a) proving the correctness of these two theories that are so vital for our civilisation, but the correctness of which many orthodox scientists try to undermine through quite vicious attacks, (b) confirming the correctness of other conclusions that also result from these two theories, e.g. correctness of the conclusion about existence of the universal intellect, or about existence and operation of moral laws and moral field, (c) supplying people with highly useful information about the design and principles of operation of technical devices used by UFO-nauts, and thus making possible our self-defence against these devices, (d) demystification of UFO-nauts, means revealing that they are not at all satanic supernatural creatures created by God just to torment humanity, but only our morally degenerated relatives from which we originate and which draw various benefits from exploiting and oppressing us. These relatives use technical devices in the same way as we do. Only that their devices are much more advanced from ours, although still possible to be understood and constructed by us on Earth.

This volume, similarly like two volumes that proceed it, and like subsection A3, should be almost a compulsory literature for all these people, who either research UFOs, or just are interested in UFO subject area.

CONTENT

of the volume 14 of monograph [1/4_E] "Advanced magnetic devices", ISBN 0-9583727-4-8

<u>Page</u>	<u>Chapter</u>
1	Title page
2	Abstract of volume 14
3	Content of volume 14 (notice that the complete content of monograph [1/4 _E] is contained in volume 1)

Volume 14: Validation of the Magnocraft - part 3: Oscillatory Chambers used in UFOs

Q-1	Q. CONTEMPORARY SIGHTINGS OF FOUR-PROPULSOR UFOs
Q-1	Q1. Classic sightings of four-propulsor UFOs
Q-3	Q2. Photographs of four-propulsor UFOs
Q-4	Q3. Concluding this chapter
Q-5/7	3 illustrations (Figures Q1 to Q3)
R-8	R. SIGHTINGS OF UFOonauts WHO USE MAGNETIC PERSONAL PROPULSION
R-8	R1. The characteristic appearance of the wearers of personal propulsion
R-9	R2. The extraordinary abilities of UFOonauts wearing personal propulsion garments
R-11	R3. Scorched footprints left by personal propulsion of a UFOonaut
R-12	R4. Mythological descriptions of the use of magnetic personal propulsion
R-16	R4.1. Vampires and other mythological creatures that used to exploit people
R-23	R4.2. Blood sucking "mascots" of UFOonauts
R-33	R5. Historic descriptions of the use of magnetic personal propulsion of UFOonauts
R-36	R6. Philosophical trap
R-37	R7. Summary
R-38/44	7 illustrations (R1 to R7)
S-45	L. EVIDENCE CONFIRMING THE USE OF THE OSCILLATORY CHAMBER ON UFOs
S-45	S1. Contemporary observations and photographs of Oscillatory Chambers used in UFO propulsors
S-46	S1.1. Columns of magnetic field yield from UFO propulsors are square in the cross-section
S-47	S1.2. Outlets of UFO propulsors are square and reveal gold or yellow bands of electric sparks rotating inside
S-49	S1.3. Twin-chamber capsules formed from two Oscillatory Chambers are frequently observed in UFOs and even photographed
S-51	S1.4. Oscillatory Chambers have been seen on the decks of UFOs as described by numerous abductees
S-54	S2. Indirect confirmations that UFOs use Oscillatory Chambers
S-54	S3. Material (hard) evidence left by UFO Oscillatory Chambers
S-55	S4. Mythological descriptions of the Oscillatory Chamber
S-56	S5. Historical descriptions of the Oscillatory Chamber
S-59	S6. A photograph of the octagonal oscillatory chamber from invisible UFO of the second generation
S-69	S7. To conclude this chapter
S-71/78	8 illustrations (S1 to S8)
T-79	T. SIGHTINGS OF UFOs OF THE SECOND AND THIRD GENERATIONS

T-79	T1. Observations of Oscillatory Chambers of second and third generations
T-81	T2. Observations of telekinetic UFOs in operation
T-85	T3. The evidence confirming the existence of UFOs that operate as Time Vehicles
T-90	T4. The level of technology in UFOs of the second and third generation
T-98	T5. Summary
T-100/101	2 Figures (Photographs T1 - of a UFO second generation, T2 - time vehicles)

Notes:

(1) A Polish language version of this monograph [1/4] is also available. Therefore, in case there is any difficulty with accessing an English version of this monograph, while the reader knows the Polish language, then it could be beneficial for him/her to read the Polish version of this monograph.

(2) Both language versions in this monograph [1/4], namely English and Polish, use the same illustrations. Only captions under these illustrations use a different language. Therefore, if illustrations for the English version are difficult to access or unreadable, then illustrations for the Polish version can be used equally well. It is also worth to know, that enlarged copies of all the illustrations for this monograph [1/4] are made available in the Internet. So in order to e.g. examine enlarged copies of these illustrations, it is worth to view them directly from the Internet. To find them, the reader needs to find any totaliztic web page which I authorise, e.g. by typing the key word "**totalizm**" to any search engine (e.g. to www.google.com), and then, after running a totaliztic web page, the reader needs to run from it the web page named "text_1_4.htm" available on the same server, or choose the option [1/4] from the menu of that totaliztic web page. Note that all totaliztic web pages allow also the uploading of free copies of this monograph [1/4].

(3) In case of making a printout of the above list of content, the page numbers provided here not necessarily need to correspond to the page numbers that appear on subsequent pages. This is because the formatting of this monograph was made for the font "Arial" (size: 12 pt), and for the printer "HP LaserJet 5MP" controlled from the word-processor "Word for Windows XP". All other fonts and other printers are going to cause a different density of print, and thus also a different allocation of page numbers.

Chapter Q.**CONTEMPORARY SIGHTINGS OF FOUR-PROPULSOR UFOs**

Since it is formally proven that UFOs are already operational Magnocraft (see the deductions from subsection P2), the validity of all conclusions derived from the Theory of the Magnocraft became verifiable through the observation of UFOs. So far, in chapters O to P, the feasibility of building the Magnocraft has been validated. The deductions that follow are to check the validity of the theory behind the Four-Propulsor Vehicle, described in chapter D.

The propulsors used by the Four-Propulsor Vehicles are based on the so-called "spider configuration" described in subsection C7.2. Thus they drastically differ in appearance and properties from those propulsors used by the discoidal Magnocraft and by Magnetic Personal Propulsion. We remember that the propulsors of the discoidal Magnocraft in normal cases are based on the "twin-chamber capsule" described in subsections C7.1 and F1. (The only exception from this rule are the first prototypes of discoidal Magnocraft representing the stage 1A from subsection M6. Their propulsors are to use the "prototype spider configurations" of oscillatory chambers.) Also the shape and general design of the Four-Propulsor Vehicle is different from discoidal vehicles - as described in chapter D. For all these reasons, attributes of Four-Propulsor UFOs should easily be distinguishable from those of the discoidal UFOs. I carefully examined evidence available on UFOs, and have selected a number of cases which confirm that Four-Propulsor UFOs have already been observed on Earth on many occasions. The most representative of such evidence is discussed below.

Q1. Classic sightings of four-propulsor UFOs

Probably the most documented and investigated observation of a Four-Propulsor UFO, is the case of abduction of a Polish farmer, the late Jan Wolski from the small village of Emilcin near Opole Lubelskie, Poland, which took place on 10 May 1978. (His postal address was: Mr Jan Wolski, Emilcin kolo Opole Lubelskie, 24-325 Skokow, Poland.) Here is a brief description of this abduction together with details of the vehicle.

"On 10 May 1978 early in the morning Mr Wolski drove his horse wagon through a forestry road near his village. He noticed two small humanoids (about 1.10 metre high) walking along this road, dressed in tight grey overalls with hoods. They moved in a clumsy and strange way, keeping their legs apart (see the properties of Magnetic Personal Propulsion). When Wolski began overtaking them, they jumped from both sides into his wagon, surprising him with their nimbleness. At this moment the horse pulled sharply indicating the unproportional increase in the weight of the wagon. Sitting either side of him, they impetuously discussed something between themselves, using a "devil" kind of language, consisting of sharp, quick sounds - coo and chuckle like. (The melody of this language supposedly sounded like a coo of pigeons mixed with laughter of hyenas.) This convinced him that they were not humans. When the wagon reached a small clearing, Wolski noticed an unusual vehicle hovering above the ground at a height of about 30 metres - see **Figure Q1**.

The vehicle had the shape of a rectangular hut with the roof looking like a small pyramid. Its body slightly resembled that of a twin-rotor helicopter. It had no windows, only an open doorway located in the centre of the facing wall. The doorway revealed the thickness of the walls estimated by Wolski to be about 0.2 metre. The UFO had no flanges, wings, legs or wheels. The only elements protruding from its body were four barrel-like devices (propulsors) located exactly at the corners of the main body. From each of these barrels a dark, spinning, vertical "drill" extended downward. The medium that constituted these "drills" looked like very dark smoke. Its appearance resembled that of a solid substance, but it permeated

underground without causing any visible opening or disturbance of the soil. All four "drills" were spinning very rapidly, although there was no noticeable motion of the air. While spinning they emitted a faint humming noise, quite similar to the sound produced by a bumblebee.

From the door of the UFO a small platform attached to four plastic ropes descended. One of the humanoids stepped on it and invited Wolski to follow him. The platform was firm and surprisingly steady under foot, although it looked fragile and unstable. It lifted Wolski and one of the humanoids to the vehicle, where another two humanoids were already waiting. The fourth humanoid joined the rest in a second descent of the platform. Inside the vehicle there was a dark, right-angled room. The only source of light was the door opening. The door was rolled up near the doorway into a vertical tube. Floor, walls and the flat ceiling looked as though they were cast from a material similar to glass, which was hard to the touch. The room was empty, with no furniture, only a few chairs attached to the wall opposite the door, and two control levers that were near the door sticking out from the wall.

After a brief medical examination and an activity that looked like taking photographs, the humanoids released Wolski. When rushing his horses home he noticed that the vehicle departed. While flying at a low speed above Emilcin, the UFO was also seen by another witness who described it as a "flying bus". Shortly after passing above this village, the vehicle turned sharply up, accelerated, produced a **loud sonic bang** and disappeared from view. The examination of the site revealed material marks left by the UFO and its crew, including small imprints of the humanoids' shoes looking like trapezoids, scorched vegetation at the forest clearing, and a mysterious "devil stone" hidden underground, which turned out to be the main subject of this UFO visit." (Notice that the photograph of this particular devil stone is shown in Figure K1c of English monograph [1e]. As it is explained in subsection VB4.3.1, the interest of UFOonauts in this particular stone was later definitely confirmed. Soon after this stone become an object of research and after an emission of a strange radiation was detected on it, it was subjected to a hidden sabotage by UFOonauts and disappeared forever well hidden by UFO collaborators impersonating UFOlogists.)

The events following Wolski's abduction took a course tragically similar to so many other close encounters with UFOs. The initial investigation of evidence and events proved the validity of his description and his experience. This, however, was unacceptable to many so-called "UFO sceptics" who behaved as if their chief life goal was to annihilate this excellent chance of finding out the truth about extraterrestrials. They began a vigorous campaign of "debunking" using irrational arguments, publicly trying to ridicule the case, and exerting various pressures on people involved. The argumentation of both sides escalated and seemed to get out of control. Finally, around 1989 someone invented an idea of announcing that Wolski's abduction was a "joke" played to him by a group of students (this announcement was not accompanied by the reason for such an enormously sophisticated and expensive "joke", or by explanations how it possibly could be done by students who had no access to the equipment or characters being seen). Although this announcement was unconvincing and contrary to evidence, it achieved its intended goal of ceasing further publicity and investigations for this case. In this manner the scientific value of this extremely informative UFO observation was also squandered. Mr Jan Wolski died on 8 January 1990, at the age of 83.

All properties of Wolski's UFO correspond exactly to those envisaged for a Four-Propulsor Spacecraft. The appearance and operation of its barrel-like propulsors also match in every detail those unique to spider configurations. This makes Wolski's abduction one of the best documented observations of a Four-Propulsor UFO.

A Four-Propulsor UFO was also observed in the Roseneath suburb of Dunedin, New Zealand, by a local resident who prepared a detailed report of his sighting but requested his name and address be kept confidential. The sighting took place during a clear autumn night, when strong moonlight increased visibility. It provided excellent confirmation for the expected configuration of UFO's magnetic circuits that ionize the air. **Figure Q2** illustrates what was seen. Here is the eye-witness report which describes this sighting:

"It was 2.56 a.m. on 23 March 1989. I was awoken by a **loud sonic bang** similar to that

caused by a supersonic aeroplane crossing the sound barrier (I remembered that a similar bang also awoke me about 4 months earlier). I decided to glance through my window. It was a clear night with strong moonlight shining on the landscape. I noticed a vehicle hovering above a patch of bush on the other side of the valley, about 1 kilometre away from my home. It was suspended motionless, about 10 metres above ground level on the unpopulated slope of the hill known locally as "Blue Skin Hill", slightly to the right of the Sawyers Bay water reservoir. The position of this vehicle was approximately level with my house and located in the direction of NNW from my window, i.e. on the magnetic azimuth 330° . The UFO was clearly distinguishable against the background of the moonlight slope, because of the lines of bluish-white steady light that outlined its body. It had the shape of a transparent, cubical-type hut, covered by a gable roof. The side dimension of its square walls I estimate at about 9 metres. From the vehicle's corners four columns of white-blue glitter light shone downwards. The glitter light grains of these columns resembled something like the flickering of 'white noise' visible on TV screens when working sets do not receive any station. Each side wall of the vehicle was crossed by strands of steady (i.e. not glittering) bluish-white light. Also each edge of the vehicle was outlined by the layer of the same light. The lines of light appearing on the rear of the vehicle were also visible through its transparent body.

After observing the vehicle for a few minutes I stopped looking. But the strange view aroused my curiosity, so about 10 minutes later I had another look. The vehicle was still above the same spot. After a short observation I stopped looking. At about 3:15 I looked again and checked for the third time. The vehicle was gone. Four days later I prepared a drawing of what I saw, which I have enclosed with this report."

My later field analysis of this sighting allowed a number of technical details to be established about this UFO. For example, it revealed that the UFO most probably represented a type T5 vehicle, whose design and approximate day-time appearance is illustrated in Figure D1. Also it confirmed that the observed geometry and mutual relationship of dimensions of this vehicle correspond to those described theoretically by the equations contained in chapter D. In addition the analysis revealed that this UFO was positioned so that its right rear wall was facing magnetic north. Moreover, the vehicle hovered slanted from a vertical position at the angle of about 20° so that the four columns of flickering light which extended down from its corners were parallel to the force lines of the local magnetic field. (The magnetic inclination for Dunedin is about $I=70^\circ$.) These last two findings confirm that the vehicle's propulsion system utilized the Earth's magnetic field, and for this reason the UFO needed to remain aligned to the force lines of this field.

Another classic observation of a Four-Propulsor UFO was the abduction of Carl Higdon on 25 October 1974, which is described in subsection T2 - see evidence #3, and illustrated in Figure R4 (for details see books [2P] page 171, [5P] page 16). The UFO that abducted Mr. Higdon also had the shape of a "cubicle". Unfortunately the descriptions that are available concentrate more on the events than on the vehicle, therefore it is impossible to determine at this stage whether Mr. Higdon noticed barrel-shaped propulsors protruding from the corners of this UFO.

Q2. Photographs of four-propulsor UFOs

In some instances Four-Propulsor UFOs have been photographed. The best example that I have found so-far is the photograph taken above Albiosc, France, in 1974 - see **Figure Q3**. The four columns of spinning ionized air yield at the corners of this vehicle could only be produced by propulsors that utilize the spider configuration of Oscillatory Chambers. The number of these columns and their location in relation to the body of this vehicle indicate that the photographed spaceship represents a Four-Propulsor UFO.

Q3. Concluding this chapter

Although this chapter, when compared with chapters O and P, presents not so frequently appearing type of UFOs, it still adds a further contribution to the vast body of evidence that confirms the validity of the Theory of the Magnocraft elaborated in this monograph. This evidence constantly ascertains that various vehicles known under the general name of UFOs: (1) exist objectively, (2) are explainable on the basis of contemporary knowledge, (3) document the successful technical implementation of the propulsion systems whose construction on Earth is proposed by this monograph, and (4) should be thoroughly pursued and investigated as their copying may win us precious time and save us a lot of research and expense.

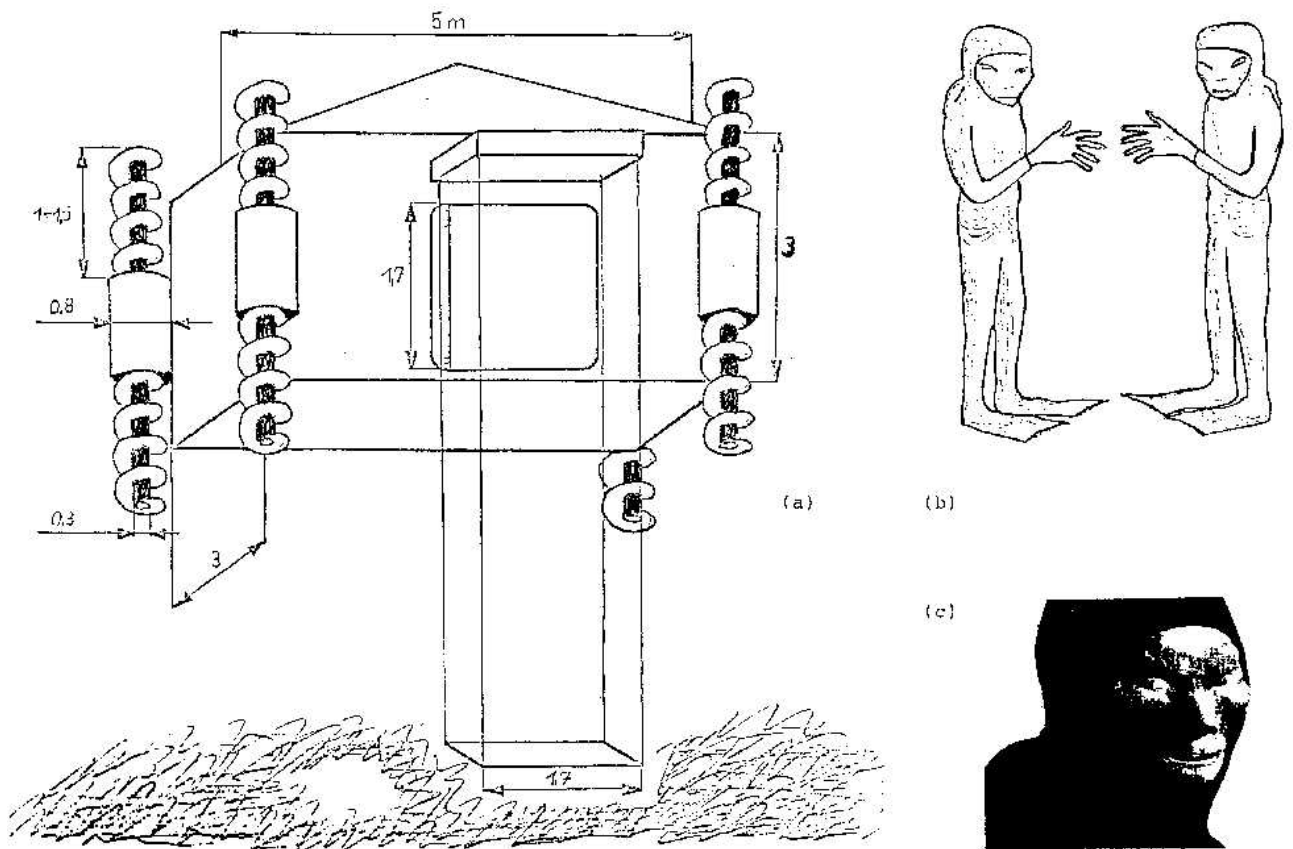

Fig. Q1. A reconstruction (from descriptions) of the appearance of a **Four-Propulsor UFO** which abducted a **Polish farmer, the late Jan Wolski** of Emilcin near Opole Lubelskie, on 10 May 1978. The vehicle had the shape of a windowless hut, or "cubicle", with a doorway and a roof in the shape of a pyramid. On the corners of the vehicle four vertical barrel-like propelling devices were located. These devices produced thin, long, and extremely fast spinning columns, which the witness described as looking like "black drills". The columns permeated under the ground, without opening or disturbing the soil. Also the rotation of these columns did not induce any motion to the stationary air. The UFO had a single square room inside, with a flat ceiling that did not correspond to the shape of the roof. The crew and abductee entered the UFO by a fragile (but stable) platform lifted to the doorway by four plastic ropes, as shown in this illustration.

- (a) A side view of the vehicle. All dimensions given in meters.
- (b) The general appearance of Wolski's abductors.
- (c) Facial features of a UFO-naut reconstructed from Wolski's descriptions.

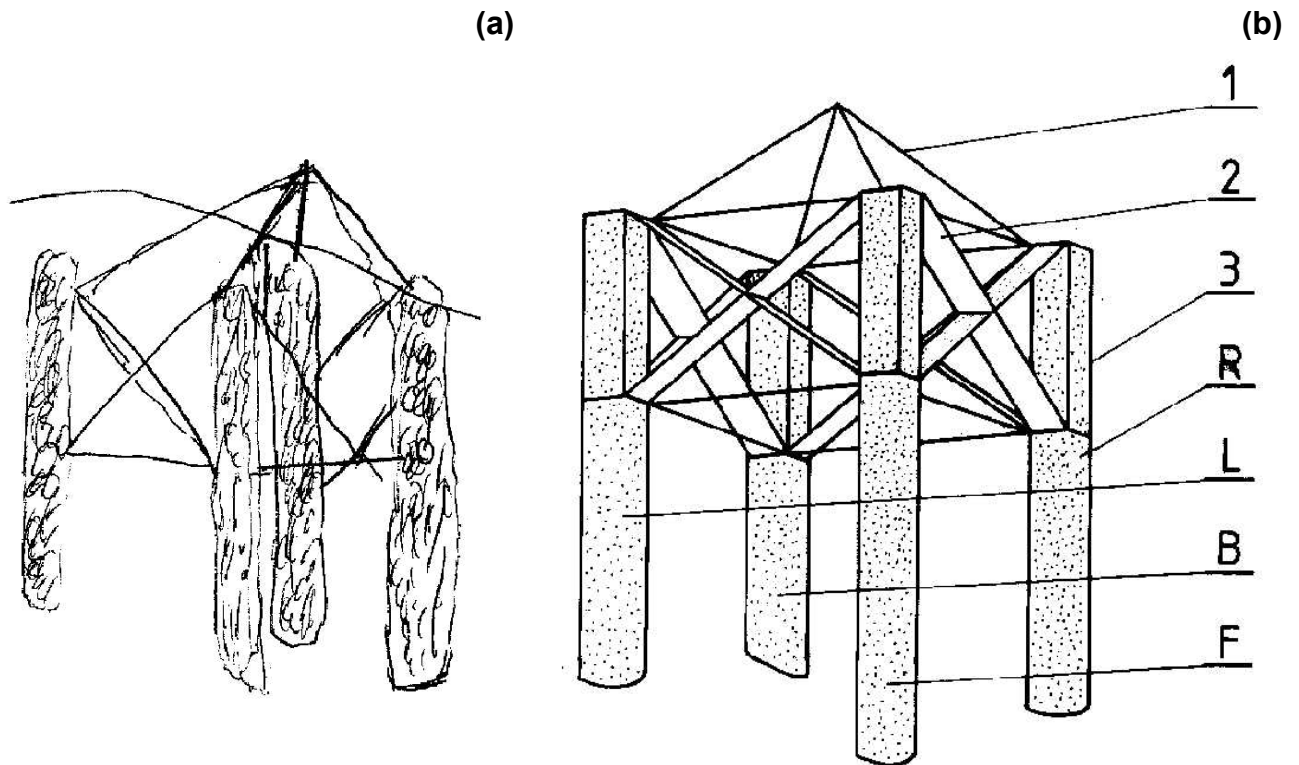

Fig. Q2. The night appearance of a Four-Propulsor UFO which hovered motionlessly above the ground. The only visible features were strands of a white-blue light emitted by the magnetically ionized air that outlined the magnetic circuits and edges of the spaceship (the day-time appearance of this vehicle is illustrated in Figure D1). The lights at the vehicle's rear were also seen through its transparent body. The illustrated UFO was observed in the Roseneath suburb of Dunedin, New Zealand, at 2.56 a.m. on 23 March 1989. It hovered about 10 metres above ground level on the unpopulated slope of the hill locally known as "Blue Skin Hill". During the sighting the object was about 1 kilometre distant from the observer, and positioned in the NNW direction (at the magnetic azimuth 330°).

(a) The witness's original drawing of this UFO prepared from memory 4 days after the sighting took place.

(b) My reconstruction of the possible appearance of this UFO, based on the theory behind the Four-Propulsor Magnocraft, the eye-witness directions, and the field research of the sighting. Shown are: R, L, B, F - right, left, back and forth columns of a "white noise" type glittering light that was emitted by the spinning magnetic circuits of the vehicle's propulsors; 1 - non-glittering layers of the ionized air glowing blue-white that outlines all the sharp edges of the vehicle; 2 - the crossed strands of glowing air that was ionized along the paths of magnetic circuits passing from each magnetic pole of every propulsor to the opposite magnetic poles of the next propulsors (also bluish and non-glittering); 3 - the transparent walls of the main Oscillatory Chamber from each propulsor.



Fig. Q3. A Four-Propulsor UFO photographed in flight near Albiosc in the Vosges mountains in France. It was recorded on film at 11:30 pm on 23 March 1974 by a local doctor who insisted on remaining anonymous - see [1P2] page 223. The above photograph presents an ascending vehicle flying in the magnetic whirl mode of operation, whose crew-cabin is surrounded by a red glow. Notice that in New Zealand (southern hemisphere) this red glow is replaced by a blue one - see Figure Q2. This in turn corresponds perfectly to the expected colours of the air glow within the range of the propulsors' magnetic poles (i.e. red near N poles and blue near S poles). In the four corners of the UFO, white, glowing columns of a spinning magnetic field are clearly distinguishable. Such columns of a whirling magnetic field can be produced only by magnetic propulsors that contain spider configurations. The mutual orientation of these columns in the above photograph, and the relative proportion of their dimensions, indicate that the pictured vehicle represented a Four-Propulsor Spacecraft, similar to the one shown in Figure Q1.

Chapter R.**SIGHTINGS OF UFOonauts WHO USE MAGNETIC PERSONAL PROPULSION**

Recent observations of UFOonauts provide strong evidence that these extraterrestrial beings already use the type of personal propulsion whose attributes correspond in every detail to those listed in subsection E6. The most representative of this evidence, which I accumulated during the research to-date, is presented in this chapter. Unfortunately, the need for consistency does not permit to comment on many of further encounters in which the attributes of the aliens' personal propulsion were reported. But the analyses presented here formulate the rules of interpretation which can be extended easily to all other cases we have knowledge of.

The majority of evidence that supports deductions from this chapter was chosen from classic cases of UFOlogy. Therefore, detailed descriptions of each of these cases is contained in numerous books. For each case discussed in this chapter I have provided references to resource materials.

R1. The characteristic appearance of the wearers of personal propulsion

In all reports describing UFOonauts, the attributes of a personal propulsion garment are evidently present. The suits worn by aliens are designed as one-piece overalls (usually silver, grey, or green colour) that limit to a minimum the area of skin exposed to the action of a powerful magnetic field. Moreover, almost always these suits include a heavy belt, shoes with thick soles (or noticeable epaulettes), and a hood or helmet. One of the better investigated encounters with UFOonauts wearing such belts and shoes was that of Stanislaw Maslowski of Wroclaw, Poland - see **Figure R1** (details of Maslowski's encounter are presented in subsection S1.3.) Frequently the shoes and belt are of a different colour (e.g. red) from the rest of the garment. Also numerous witnesses confirm that during poor light conditions the belt and shoes (or epaulettes) emit a glow. One of the many examples of such observations is shown in **Figure R2**.

In order to use the personal propulsion garments containing the main propulsors in the shoes, the UFOonauts must adopt a very characteristic body stance. The first of two possible stances requires that both legs are permanently set apart - see the descriptions in subsection E2. The photograph from **Figure R3** shows a UFOonaut in just such a pose. This photograph is one of four flash pictures taken on the night of 17 October 1973 just after 10 p.m., by police chief Jeff Greenhaw of Falkville, Alabama, USA - see **[1R1]** Nigel Blundell, Roger Boar: "The World's Greatest UFO Mysteries". Octopus Books Limited, London 1983, ISBN 0-7064-1770-4, page 116. In spite of the fast motion of the photographed alien "faster than any human I ever saw", in all of the four photos the position of the UFOonaut's legs remain set apart. This can only be explained by the action of the forces "B" of reciprocal repulsion occurring between the main propulsors from the soles of the alien's shoes (see Figure E3).

The second possible stance to be used by the wearers of the personal propulsion garments with the main propulsors in the shoes, is when the legs are tucked up into a squat position. This stance is caused when the balance between the compressing forces "Q" and tensing forces "A" and "R" is disturbed by the wearer of this garment - see Figure E3. In such a case the attracting forces "Q" between the propulsors in the shoes and those in the belt become dominant, folding the wearer's legs. The upper UFOonaut in Figure R1 displays this squat stance.

Use of the personal propulsion garments induces electric charges in non-conductive materials from the vicinity. Thus the hair on heads and hands which are uncovered must stand erect. Carl Higdon met an UFOonaut at the northern edge of Medicine Bow National Forest

(south of Rawlings), Wyoming, USA, on 25 October 1974, shortly after 4:15 p.m. - see [2R1] Ronald D. Story (editor): "The Encyclopedia of UFOs". New English Library, London 1980, ISBN 0-450-04118-2, page 171; and [3R1] Joshua Strickland: "There are aliens on earth! Encounters". Grosset & Dunlop, New York, 1979, ISBN 0-448-15078-6, page 15. He noticed that hair on the alien's scalp was standing on end - see **Figure R4**. (More details of Higdon's encounter are contained in subsection T2 - item #3.) Also Stanislaw Maslowski during his encounter, illustrated in Figure R1, was surprised and amused because the blood-red hair on the face and hands of the nearest alien was standing on end.

R2. The extraordinary abilities of UFOonauts wearing personal propulsion garments

The most distinctive characteristic of the UFOonauts wearing their personal propulsion garments is that they are able to fly noiselessly. This is confirmed by numerous witnesses who actually saw UFOonauts flying in the air.

A well-known case when the flights of aliens were observed is the Hopkinsville incident discussed further in this subsection. After one of the aliens was shot off the kitchen roof, he/she floated in the air to a distance of about 12 metres - see description in [2R1] page 191.

The Thew family of Temuka in New Zealand, the observation of whom is described in subsection S1.1, with visible emotion reported to me their extraordinary experience with a flying UFOonaut. To the right side of the detached configuration of two UFOs which hovered above their house they saw a small figure similar to that of a child, wearing a heavy space suit. This figure hovered motionlessly in mid-air without any support or physical connection with the vehicle.

There are also some encounters in which the flying alien is the main focus of the entire observation. An example is the multiple sighting of the flying alien known locally as "mothman" who terrorized residents of Point Pleasant in West Virginia, USA, during 1966/67; or the sightings of "big bird" creatures in Rio Grande Valley, Texas, USA, in 1976 - see [2R1] page 236 and [1R2] Milt Machlin, Tim Beckley: "UFO". Quick Fox, New York, 1981, ISBN 0-8256-3182-3, page 117. Also the UFOonauts presented in Figure R1 were witnessed hovering (not standing) about a half meter above the ground. The grass under their feet was noticed to move vigorously (i.e. their personal propulsion must work in the "magnetic whirl" mode of operation).

An excellent observation of a flying UFOonaut was made by Wojciech Godziszewski (ul. Szczecinska 2c, 72-003 Dobra Szczecinska, Poland). He later showed to me the place of his experience and explained details. Here is his description of what he saw. On 18 March 1978 shortly after 9 pm, he was driving his Fiat 126 car. His wife was a passenger. He spotted four spheres glowing with orange and yellow lights (i.e. time vehicles) as they manoeuvred above the forest about 3 kilometres behind the village Solec. Without a second thought he turned his car and speeded up to make a closer observation. Around 500 metres before the area where these UFOs hovered he noted a strange alien about 1 metre tall as it hovered motionlessly above the centre of the asphalt road. The alien was wearing a dark-brown, tight, one-piece costume, in the colour and consistency resembling the fur of a seal or a thick wet-suit of divers. The costume ended with a hood that tightly surrounded the whole head showing only a small fragment of white face with large, round, seal-like eyes. The being also wore a white belt around 10 cm wide which glowed with a kind of phosphoric light. The same type of glow was emitted from under its feet. On the back it carried a kind of a backpack, i.e. a square hump of the volume of about two bricks. The being was hovering at the height of around a half of meter above the level of asphalt, oriented in a slanted position of body that resembled that of a "sitting dog". The legs and hands were spread, slanted about 45° in relation to the body. The head was lifted so that the being was looking towards the approaching car. When the car came at a distance of about 50 metres, the alien turned back and rapidly accelerated maintaining a constant distance of around 50 metres. During the flight it very slowly fidgeted with its legs and

hands as if it tried to balance its motion. Godziszewski accelerated in order to come closer and to have a better look at this extraordinary being. However, after pushing the accelerator to the floor and achieving the highest speed his small Fiat could maintain, the alien still maintained the same distance of about 50 metres. Thus, through around half a kilometre of a lone road through a forest, this unusual couple was moving: an alien flying in the air, and a small Fiat chasing it at full speed. Rapidly the alien turned right into a perpendicular forestry road. It changed its direction at 90° angle without a benefit of any radius, while still maintaining its full speed. Of course the Fiat was not so manoeuvrable. It took quite a distance to loose the speed (at that moment estimated by Godziszewski at about 120 km/h). Thus, after the car backed towards the entry to this forestry road and turned into it, the alien was gone. However, around 15 meters after entering this forestry road the car was saturated with the feeling of terror and paralysis, perceived as if these were sent by some telepathic means. This terror and paralysis made it impossible to further pursue the road and forced Godziszewski to hastily return home.

The personal propulsion of UFO-nauts also gives them the ability to perform various other movements which contradict our understanding of physical laws. For example, a UFO-naut who walks a vertical wall like an insect is shown in **Figure R5** (see [3R1] page 14).

The most extraordinary ability of UFO-nauts is their resistance to bullets fired at them. The best account of this ability is contained in the reports from Hopkinsville, Kentucky, USA (an area where people "shoot first, then ask questions"). The Hopkinsville encounter took place on August 21, 1965 - see [2R1] page 190 and [1R1] page 108. Here is a brief summary.

The Langford family from Sutton Farm (eight adults and three children) saw a brightly glowing object descending behind a barn. A creature in a glowing silver suit, about a meter tall, came towards them. Two men grabbed a 12-gauge shotgun and a 22-calibre pistol, and fired at close range. The being was knocked over - but to the amazement of the watchers, it then jumped up again and scurried away. The stunned family locked themselves inside their home. Then one of the women looked out of the dining room window and saw a face peering in at her, with wide slit eyes behind a helmet visor. The men rushed into the room and fired, but again the creature, although hit, ran away. A total of almost 50 rounds were fired at the five aliens over the next 20 minutes, but none of the bullets stopped them. Whenever one of the creatures was hit, it would float or fall over or run for cover. All the shots that struck them sounded as though they were hitting a tin bucket. The beings made no sound. The undergrowth would rustle as they went through it, but there was no sound of walking. The beings were seemingly weightless, as they would float down from trees rather than fall from them.

The Hopkinsville incident is perfect confirmation of the formation of an inductive shield by the personal propulsion garments of UFO-nauts.

The other important electromagnetic manifestation of the personal propulsion in operation is the induction of electric currents in the closed circuits of wiring, especially when these circuits contain a transformer at their entry. In this way television sets or radio receivers can malfunction or even burn out completely. An example which documents such effects caused by UFO-nauts is the following chain of incidents, the first of which took place in Broadhaven, England, in the early hours of April 24, 1977 - see [1R1] page 140.

Billy and Pauline Coombs were sitting in their front room at 1 a.m., when Pauline suddenly turned to look out the window. Blocking it was a towering, eerie figure wearing a silver suit. Billy turned in his seat and also saw the monstrous outline. It was wearing a helmet with some sort of shiny visor. A pipe went from the mouth to the back of the head. The creature radiated a sort of luminous light and when it touched the window, the pane started to rattle as if all hell had broken loose - yet there was no wind. The family had two souvenirs of the incident - a burned out television set, and a rose bush near the window which was badly scorched. For a year after that, inexplicable happenings made the family's life a misery. The children frequently saw bright lights landing in the fields and found scorch marks the next morning. On a trip to the coast at nearby St. Bride's Bay, they saw two silvery-suited figures and a flying disc which seemed to disappear into rock (refer to subsections L1 and T1). Two of the children received

strange burns. Five television sets and eight cars mysteriously burned out. Then, as suddenly as the incidents had begun, they stopped (i.e. a scientific expedition of UFO-nauts probably returned to its planet).

There are also quite frequent observations of UFO-nauts during which the aliens' ability to become invisible is manifested. Classic examples of this ability are the cases of the LeBel family (taking place in New England, USA, during 1977 and 1978 - see [2R2] Raymond E. Fowler: "Casebook of a UFO investigator, a personal memoir". Prentice-Hall, Inc., Englewood Cliffs, New Jersey, 1981, ISBN 0-13-117432-0, page 157) and the Andreasson family (described in the book [3R2] by R.E. Fowler, "The Andreasson Affair, Phase Two", Prentice Hall, Inc., 1982, ISBN 0-13-0366-2). This kind of evidence confirms that extremely efficient magnetic lenses can also be formed by the personal propulsion garments of UFO-nauts.

R3. Scorched footprints left by personal propulsion of a UFO-naut

The magnetic propulsors mounted in the shoes of the UFO-nauts are also capable of making scorch marks in some organic matter. The marks left by such personal propulsion display physical attributes similar to the ones caused by landings of UFO vehicles (compare subsections O5.1 and F10). The best evidence of the scorching abilities of personal propulsion of UFO-nauts present in my files, concerns the case of Jerzy Wasilewski of Wroclaw, Poland, the description of which follows.

On 4 September 1979, around 9:30 a.m., the flat of Mr Jerzy Wasilewski (ul. Kruszwicka 53/9, Wroclaw, Poland), located on the 4th (highest) floor of the building, was visited by a UFO-naut wearing a personal propulsion garment. The alien entered the flat through an open window in the kitchen, burning a chain of mushrooms that was drying across this window. As was established during later research, the alien investigated the dwelling as he/she flew around. After reaching the main doors, the being descended into the corridor and walked back to the kitchen window from which he/she flew out. While walking along the tiles of PVC (PolyVinyl Chloride) that covered the floor, his/her propulsors from the shoes left 17 magnetically scorched marks arranged into a "footprint trail". Each mark resembled a circle about 13 [mm] in diameter - see **Figure R6**. This means that the magnetic field of its propulsors was spinning all the time, probably to create an effective "inductive shield" in order to prevent the alien from an unexpected bullet (the non-spinning field would produce square marks - see subsection S1). The mean distance between subsequent "steps" was about 0.4 meter.

The PVC tiles containing these marks were examined thoroughly by scientists from the Institute of Nonorganic Chemistry at the Technical University of Wroclaw, Poland. Listed below are the properties of the marks on these tiles, which were established during this examination:

1. The substance of the PVC tiles remained in its original structure inside the marks.
2. The surface of the marks displayed no trace of any mechanical deformation or crushing.
3. Any unfamiliar substances (even a trace quantity) were absent in the native material in the marks. (Such substances would need to be present if the marks would be burn in a chemical manner.)
4. There was no trace of burned Polyvinyl Chloride. This substance burns if the plates are exposed to a temperature greater than 130 °C.
5. The monostrophic, wavy, black patterns were distinguishable on the surface of the marks. Their thickness is several microns. The chemical composition of the patterns indicates that their cause could only be the action of an active ozone attacking the Polyvinyl Chloride particles.
6. The tiles in the area surrounding the marks were strongly discoloured. This indicates that a high energy agent (i.e. a powerful magnetic field) acted upon the tiles.

The above properties of the marks led to establishing that the following causes must be

excluded as a possible cause:

- (a) Burning by contact with a hot, solid object.
- (b) Burning by a stream of hot gases, plasma or electrons.
- (c) Mechanical imprint or obliteration.
- (d) Impact by a decompressing stream of a cold medium.

In conclusion of the research, the only cause for these marks must be the concentrated action of an extremely strong, pulsating magnetic field, accompanied by a simultaneous action of the air ionized by this field (especially highly active ozone) that was in contact with the surface of the tiles.

On the day of their appearance, the alien's footprints had a very intensive, chalk-white colour which contrasted with the bluish-grey background of the rest of the PVC tiles. On these white marks the black wavy pattern of the ozone action was clearly distinguishable. But, as time passed, the intensity of the whiteness of the marks gradually diminished. The restoration of the tiles' original colour resembled the curve of radioactive isotope disintegration, in which the period of half-life was equal to about 120 days. When in 1982, just before leaving Poland, I saw these tiles for the last time, the colour of the marks was indistinguishable from their background. But the black ozone pattern remained unchanged.

When the footprints were first reported, the Wroclaw UFO research organization "Wzgorze Partyzantow" was aware of their extreme importance as being material evidence of UFO activity. Therefore, an instant decision was made to exchange the PVC floor from Mr Wasilewski's flat to a parquet floor in order to collect and preserve the marked tiles. As the assigning of government finances (at that time the "Wzgorze Partyzantow" was a government funded organization) required some time, Mr Eugeniusz Rolewski, then the organization's chairman, disbursed his own private funds for this operation. Until 1982 the PVC tiles with the UFO-naut footprints were carefully stored in Wroclaw amongst other UFO evidence. I believe that they are still there.

At approximately the same time two other similar incidents took place in Wroclaw. Unfortunately the footprints from these other incidents were not preserved for research. In one case a woollen carpet, in which holes caused by steps had been found, was simply thrown out before the owners realized what the evidence represented. In the other case, occurring after the Wasilewski tiles became well known due to a subsequent TV programme, the PVC tiles containing the next lot of footprints were quickly taken away by unknown private collectors before authorities reached them. All three cases showed that incidents of scorched marks left by the personal propulsion of UFO-nauts are quite common, and that only a lack of knowledge or the fear of being ridiculed discourages the people involved in such incidents from officially reporting them.

R4. Mythological descriptions of the use of magnetic personal propulsion

A close analysis of mythology of any nation reveals that it is populated with beings which now would be called UFO-nauts, but which in the past, depending on the views of their observers, were called with the use of numerous different names. In various mythologies they were referred to, for example, as fairies, elves, mist people, dwarfs, ogres, mermaids, sirens, harpies, gnomes, and in many cases also male and female devils. If one analyses the most characteristic attributes of these legendary beings, almost in every aspect they displayed similarities to today's UFO-nauts. For example the following attributes are common in both cases:

#1. Similarly as this is the case with today's UFO-nauts, these mythological beings belonged to different than people categories of existence (e.g. in mythologies they were classified as gods, children of the King of the Sea (Neptune), immortals, beings from heaven, devils, etc.), and lived in different worlds (e.g. heaven).

#2. Similarly as a number of "nocturnal" UFO-nauts which presently visit our planet, also

these mythological beings most probably evolved from a creature that is active at night. Thus in many cases these beings favoured life at night, e.g. they reluctantly tolerated our sunshine and in all their actions rather preferred the moonlight.

#3. Similar to today's UFO-nauts these beings had two opposite sexes, male and female, and had adequate sexual organs identical to humans. Also they willingly participated in sexual relationships with Earth people, and on many occasions these relationships fruited with births of babies.

#4. Analogically to present UFO-nauts these beings displayed high standards in all areas, especially in morality, social life, philosophy and education. For example they always told the truth, fulfilled their agreements, kept words they gave, showed a high responsibility for their actions, respected wishes of others, in actions always used their intelligence and logic not emotions and feelings, paid a great attention to learning and gathering knowledge, were very fluent in all arts and crafts, when only had an opportunity they taught people various crafts and skills unknown at that time on Earth, etc.

For example devils from folk legends display personalities the analysis of which gives quite shocking results. Although they are supposed to be the carriers of evil, in fact when considered objectively, in almost every legend they display higher responsibility, moral standards, truthfulness, and the respect to laws than people with whom they are forced to deal. Thus, if judging by the folk legends, then hell should be practically bankrupt long ago having such incompetent tempters in actions of which it is difficult to find anything wrong.

#5. The telepathic capabilities. Similarly to today's UFO-nauts these legendary beings were also able to read the thoughts of a person they talked to, they knew the names of people before they approached them, they always were able to guess someone's wishes, etc.

#6. The supernatural powers they displayed did not originate from the very nature of these beings, but from a technologically advanced equipment that these beings had in their disposal - e.g. from their clothes (i.e. garments of their personal propulsion), magical rods (i.e. long telekinetic twin-chamber capsules), invisible magical oil held in cubical jars (i.e. most probably magnetic field stored in twin-chamber capsules), etc.

#7. Similar to today's UFO-nauts these beings also displayed all signs of using a magnetic personal propulsion garments described in this monograph. For example they were able to fly in the air, disappear from view at any time (i.e. become invisible), had unusual physical strength, speed, unknown to ancient people an ability to communicate at a distance, were resistant to the action of our weapons, and displayed a number of other attributes which today are easy to explain with the use of advanced technology of personal propulsion garments which these beings most probably had in their disposal.

In various parts of this monograph (e.g. see subsection S5) the conclusion seems to repetitively emerge that already for thousands of years our planet has been visited by a number of highly advanced extraterrestrial civilizations. Thus, the natural consequence of these visits must be that throughout ages people must have been observing the action of magnetic personal propulsion system. From this stems **the thesis** of this subsection which states that: **"the supernatural beings under various names described in folk legends throughout centuries, in fact are ancient observations of UFO-nauts using their personal propulsion"**. In the case of successful proving the validity of this thesis, not only additional evidence for the use of personal propulsion will be gathered, but also the interpretative opening of the very rich source of data on UFO-nauts will be achieved. This source contains the accumulation of empirical experiences gathered by people for centuries. It describes the multitude of races and types of UFO-nauts which visited us in the past and most probably still visit at present, their appearance, personalities, behaviour, attributes, etc. For example it can be deduced that the so-called "devils" from folk legends in all their attributes correspond to small (i.e. 90 to 120 cm tall) nocturnal humanoids, which come to Earth from the star called by us "Zeta Reticuli" (distant 37 light years from Earth), and which currently are near the end of their 1D stage of the development (see the classification from subsection M6). Therefore by a simple studying the folk descriptions of devils it is possible to work out a relatively good picture

of these humanoids, including their psychological and social profiles.

The content of this monograph provides almost a perfect means of testing the truth of the thesis proposed above with use of the "conclusive evidence" method. It is based on a postulate contained in the last paragraph of subsection D6. According to this postulate, the beings of really supernatural origin (e.g. angels in the religious sense of this name) should retain their supernatural attributes even if somehow they are stripped from their garments. This is because their attributes are the result of who they are, not what they wore. On the other hand, UFO-nauts who use magnetic personal propulsion of the first generation must lose their supernatural attributes as soon as they loose their garments (it should be noted that the above is not valid for the personal propulsion systems of the second and third generations which are inserted surgically into bodies of users). Thus a possible disappearance of the supernatural capabilities in legendary beings after they took off their clothes would represent the "conclusive evidence" that these beings in fact utilised magnetic personal propulsion systems. Guided by the above principle of testing the thesis, I completed the review of folk legends of various nations in order to check as to whether any stories describing supernatural beings which lose their magical powers as soon as they remove their clothes exist in myths of these nations.

To his greatest astonishment he discovered that in mythology of almost every nation there are legends confirming this. In the book **[1R4]** by Katherine M. Briggs, "The Vanishing People (a study of traditional fairy beliefs)" B.T. Batsford Ltd., London 1978, ISBN 0-7134-12-40-2, page 39, there is even supplied a review of some of these myths. Generally speaking the majority of these legends limit themselves to the description how a human male got into the possession of a beautiful, supernatural female (by arresting her clothes) whom he later either forced or persuaded to become his wife. Unfortunately, unacquainted with difficulties and inconveniences of life on Earth beauties usually very soon had enough of hardships and returned to heaven. Their return usually occurred soon after they gave a birth to a child which was the fruit of their romantic passion for an Earth male. Probably the most representative of this group of legends is the one contained in the Korean mythology. Its excellent example was published under the title "The Woodcutter and the Heavenly Maiden" in the book **[2R4]** by Suzanne Crowder Han, "Korean Folk & Fairy Tales" Hollym Corporation, USA, 1991, ISBN 0-930878-03-5, pages 101 to 106. Other, slightly poorer version of the same legend is also published in the book **[3R4]** by Zong In-Sob, "Folk Tales from Korea", 3rd edition, Hollym International Corp. (18 Donald Place, New Jersey 07208, USA) 1982, ISBN 0-930878-26-4, pages 16-18. Here is its summary:

"A lone young woodcutter got to know about a lake hidden deeply in mountains where Heavenly maidens used to take their bath. Because he was too poor to buy himself an Earth wife, he decided to use a trick in order to get one of these heavenly beauties. He hid himself in a bush, and when Heavenly maidens flew down to take their bath he stole and hid clothes of the most beautiful. Thus when the time for her departure come, the beauty had no means to return to heaven. The woodcutter come out from the bush and persuaded the defenceless maiden to become his wife. Because she had no other choice, the girl agreed. For the few next years she obediently cooked him rice, swept his hut, mended his clothes and gave birth to his children. However, all the time she missed her heavenly home and family. When, after giving birth to the third child, she asked for her magical clothes, the woodcutter believing that by then she got used to the happiness of being his wife unwisely agreed. The beauty promptly put the clothes on. Immediately a black spinning cloud appeared above their house. The Heavenly maiden took one child into her one hand, second into her other hand, and the third between her legs, waved the husband goodbye, and disappeared for ever in this cloud."

Similar legends can be found in mythologies of many other nations. In order to give here an example from a completely different part of the world, in the book **[4R4]** by Edith Fowke, "Tales told in Canada", Doubleday Canada Ltd., Toronto 1986, ISBN 0-385-25041-X, pages 102 to 104, a legend originating from the Shetland Islands is quoted. Its title is "The Seal-Woman". It tells about a lone fisherman who had the good luck of encountering the isolated beach where some supernatural seals discarded their furs and in a human form had

their dance. Of course, translating this into our present language, he probably found a beach where a group of UFO-nauts wearing garments similar to furs of seals (e.g. see the clothes of a UFO-naut observed in flight by Wojciech Godziszewski of Dobra Szczecinska and described in subsection R2) undressed themselves in order to take a swim and then for relaxation they played a version of beach games (by an observer from other epoch also some from our present beach games would most probably be perceived as some kind of strange ritual dances). The clever fisherman quickly discovered that one of them was a beautiful woman. Because he was actually seeking a wife, he immediately decided to hide her seal's fur. When the time came to return, the poor seal lady could not find her fur. Thus the fisherman without great difficulty managed to persuade her to become his wife. Having no other option the seal beauty of course agreed. After bearing him a few children, she asked to return her fur. The fisherman unwisely gave it back. She quickly put it on, asked him to take a good care of their children, and then disappeared forever.

The Scottish family of MacCodrum claims that they actually originate from such a supernatural woman. Their family myth is described under the title "MacCodrum of the Seals" on pages 1 to 7 of the book [5R4] by Barbary Ker Wilson, "Scottish Folk-Tales and Legends", Oxford University Press, London 1969. Here is its summary. "A few generations ago their ancestor, Roderic MacCodrum, lived alone on the Bernerary Island (Outer Hebrides) near the coast of Scotland. One day he noted 'children of the King of the Sea' as they exercised sport on an isolated and well sheltered beach. He very much liked their garments made of a beautiful, silky texture, lying nearby on stones. Thus he took one as a souvenir and hid it in a niche above the main doors of his cottage. In the evening, when outside became cold, a naked girl of dazzling beauty came to his cottage. She asked if she could stay for the night as somehow she lost her clothes. Although the fisherman immediately connected the beauty with the silky garment he hid above the doors, he could not resist the pleasure of not revealing for some time the whereabouts of her garment. He spent the whole night comforting her in this difficult situation, and by the morning she became his wife. She gave birth to a number of children, but continually missed her family. When one time the fisherman was at the sea, a strong wind broke the doors and disclosed the garment. The beauty asked her children to say goodbye to their father and she disappeared forever. Her descendants later derived their origin from the daughter of the King of the Sea."

Very realistic, in some places even funny, legends exist in the folklore of Northern Laos. It is published under the title "The Bird Maiden" in the book [6R4] by Kristina Lindell, "Folk Tales from Kammu", Craftsman Press, Bangkok, 1980, ISBN 0-7007-0131-1, pages 43 to 49. It tells about a small but ambitious and by all means very amorous bird hunter from Laos, who spotted in one of the mountain lakes beautiful goddesses coming from heaven to take their baths. He decided to try making love to one of them. Because he heard about their supernatural powers, he prepared himself very thoroughly for his adventure. He cooked for himself a special magical meal and also learned all local rituals which would give him various magical powers. He started his plan by seizing the wings that a goddess from heaven took off before she bathed. After she finished her bath and tried to recover her wings, the amorous hunter attempted to seduce her. Unfortunately for him, the well exercised and properly fed goddess had a visible physical advantage over the small captor living only on rice. The struggle lasted the whole night through. During its course the hunter a few times paused in order to eat his magical food and to complete another magical ritual which supposed to give him special powers. His strange behaviour apparently so much amused the goddess that near morning, probably more because of the laughter than from the lack of energy, the goddess submitted. Then, instead of proposing her marriage and putting her into a pedestal as other Earth man used to do with supernatural beauties, her partner simply gave her wings back and asked her to fly to heaven. But the goddess probably was aware that this moment of passion would eventuate in pregnancy, because she did not depart hastily and volunteered to become his wife. Unfortunately the hunter already had one wife. To avoid the rivalry between both women he accommodated a new wife in the house of his aunt. Before a year passed the goddess

gave birth to a child. All the time she retained her wings and during the pregnancy quite regularly she wore them in order to take short flights {most probably in order to undergo regular medical examinations and obtain vitamin supplements in heaven}. However, she always returned to Earth afterwards. The auntie of the hunter, observing her flights, sewed for herself identical wings, only that made of textiles from Earth. When one day she jumped from the window on a first floor in order to try the operation of her new wings, poor auntie almost killed herself. The village all laughed at the goddess that although she originates from heaven and is able to fly, on Earth she is only a secondary wife. Thus soon after giving birth, the goddess had enough of all these sarcastic comments and departed to heaven forever. Some time later her husband visited her briefly with the child. After he returned back home he discovered to his deepest surprise that his whole hut was overgrown with creepers because on Earth in the meantime a lot of years elapsed although in his perception their absence was only for a very short while.

Another similar legend entitled "The man who married a girl from heaven" is contained in the book [7R4] by Albert Koutsoukis, "Indonesian Folk Tales", Rigby Limited, Djakarta 1970, SBN 85179-001-1, pages 40-44. A young Indonesian man saw one night a group of seven birds flying to a coast of a lake. When they approached he noted with a surprise that they all were beautiful women flying. When they took off their clothes he hid garments of one of them. After the bath the girl that he choose could not fly away without her clothes. Thus he proposed her to spend the night in his home. There he managed to persuade her to become his wife. Before a year elapsed she give birth to a boy. But she was a very poor cook and when next time she burned his dinner, he got angry, returned her magical clothes, and sent her back to where she came from.

If one reflects on the above legends, it is already unusual that the supernatural beings from the folk legends have sexes and sexual organs and that their relationships with humans of the opposite gender lead to the birth of children. Surprising is also that this ability to multiply in a human manner display even devils from folk stories (e.g. see the legend "The Girl who Married the Devil" from the book [8R4] by Kurt Ranke, "Folktales of Germany", Routledge & Kegan Paul, Chicago 1966, pages 42-44). Even more surprising is that by simply seizing the clothes of these beings, it is possible to annihilate their supernatural powers. In order to realize how immensely this concept of "technological supernaturality" collides with the whole idea of supernatural beings, let us consider the following example. What would be our reaction if someone would try to convince us that for example by seizing the sceptre of God, a given person could rapidly acquire Godly powers, whereas God without this divining rod would become similarly defenceless as an ordinary person.

The existence of the legends of the above type reveal striking contradictions in the idea of supernatural beings. According to this contradiction the beings described by folk legends do not have supernatural nature, but only acquire their powers from the attributes of the advanced equipment they have at their disposal (usually from a garment). But if somehow they are deprived of this equipment/garment, then they rapidly become defenceless and easy to submit, seduce, or even to bear children to their earthly masters. Because this contradiction has no support (source) nor explanation on the basis of the commonly accepted concept of supernatural beings, and simultaneously it is fully aligned with the theories presented in this monograph, it constitutes a proof for the truth of the thesis of this subsection. Thus, from now on, we should accept that **various supernatural beings described by folk mythologies are simply ancient observations of UFOnavts equipped with magnetic personal propulsion garments** and with other devices representing a technology much more advanced than our present one.

R4.1. Vampires and other mythological creatures that used to exploit people

Subsection R4 reminded us, that Earth is exploited for thousands of years by creatures

currently called UFOonauts, and that these creatures were observed by people since the most ancient times. Under various names they are described in mythologies of practically all nations of the world. In turn subsections VB1 and VB4.8 remind us again, that our planet is an object of secretive biological exploitation carried out on a cosmic scale by UFOonauts. So if we put these two together, then we realise, that mythologies of various nations must also include descriptions of evil creatures, which would correspond in attributes, behaviours, and the equipment they used, to present UFOonauts with their personal propulsion, but who would be openly portrayed in various mythologies as ruthless robbers and exploiters of biological resources of people.

After mythologies of various nations are reviewed, it turns out that such ruthless robbers of human biological resources are actually well represented in the folklore of almost every nation. According to classification provided in subsection U4.1, depending on what these creatures rob from people, they even can be subdivided into several categories. These categories include, amongst others: (a) mythical representation of UFOonauts who rob moral energy from humans, and also (b) mythical representation of UFOonauts who exploit people sexually.

The most commonly known group of creatures that ruthlessly rob people from biological resources, in European mythology is known under the name of "vampires". As this is explained in subsections U4.1 and JD1.6, in my opinion both, the existence of vampires, and their attributes, provide one of the most convincing classes of evidence for the continual biological exploitation of humanity by UFOonauts. This evidence indicates that the "milking" of humanity from moral energy is carried out for thousands of years.

Vampires in myths are charged with sucking of human blood. However, because people did not know so-far the idea of moral energy, which was only introduced by totalizm, blood surely represents here an allegoric symbol for sucking from people a kind of energy, which is equally vital like blood. After all, moral energy is exactly an equivalent of blood for our counter-bodies.

Vampires are known in folklore of almost every nation on Earth. But there is a vast body of evidence that indicates that into each folklore vampires were introduced individually and separately on the basis of empirical evidence accumulated locally by each nation throughout centuries. Their descriptions are not just copied from other nations.

One of the most vital characteristic of folklore on vampires, is that in folklore of all nations, vampires display attributes that make them identical to UFOonauts. This characteristic of UFOonauts is displayed no matter what is the appearance and anatomy of local vampires described by a given folklore. The common attributes of UFOonauts and vampires, that are present and common in all cultures and folklores on Earth, include amongst others:

#1. Appearance very similar to UFOonauts. It includes the usual size of a dwarf. Also includes long fingernails similar to "claws" put on fingers by UFOonauts, and described amongst others in subsections O6 and T4.

#2. The ability to fly in the air. Vampires fly in a manner similar as UFOonauts do it. For example European vampires use for this purpose bat-type wings similar to these attached to suits of personal propulsion of UFOonauts.

#3. Ability incapacitate their victims in a "magical" manner. This incapacitating shows characteristic attributes of hypnosis induced by technical devices.

#4. Ability to become invisible at any will.

#5. Ability to change appearance in a flash. For example, from a person that is very beautiful, vampires can turn into horrifying monsters, and vice versa. Also they can turn in a flash from a human into an animal, and vice versa. This ability is well known amongst UFOonauts that use modifiers of appearance described in subsections N3.2 and T4.

#6. Sucking the moral energy from people only. This energy is symbolised by "blood".

#7. Not sucking blood (moral energy) from animals. This is an excellent evidence in confirmation that "blood" in stories on vampires, is only an allegory for sucking from people

something that only people have. After all, blood of animals contain the same nutritions as human blood does. So just for consumption, animal blood should be equally good as human is. But animals do not accumulate moral energy that is so vital for intelligent creatures. This moral energy can only be sucked from people - for details see subsection JB3.3.

#8. An absolute necessity to continually suck human blood (moral energy) in order to sustain their own life. This seem to be an allegoric description of the absolute need of UFOonauts, who do not obey moral laws, to rob from humans moral energy that they need to live - for details see subsections JB3.3 and JD1.6.

#9. Extremely long lives. For vampires lifespan is reaching over a thousand of years. Means vampires live exactly as long as UFOonauts do.

Let us now review brief descriptions of several examples of vampire-like creatures, that I managed to collect from folklore of various nations. It is worth to notice, that the review of these creatures represents simultaneously a kind of gallery of different races of UFOonauts that occupy our planet. Their common attribute is, that according to mythology of a given nation, they suck human blood, but not suck blood of animals. But individual differences between such creatures known in mythologies of subsequent countries, reveal that their idea could not be copied from other cultures. In turn the actual existence of creatures described here is confirmed by the fact, that some races of these creatures, and also almost all attributes common to them all, appear in mythologies of nations geographically distant from each other - e.g. see Polish devil called "kurza lapka" (means "cockerel feet"), and Japanese "oni", or Japanese "kappa" and "antukuriel" of the Iban tribe from Sri Aman on Borneo. In descriptions provided below I concentrated on explaining how attributes of vampires compare to attributes that also appear in present UFOonauts.

Borneo. The Province of Sarawak on the tropical Island of Borneo is inhabited by around 29 main tribes of people, which are subdivided further into several sub-tribes and language groups. According to my research carried out during two-year long professorial contract on Borneo, each of these tribes and subtribes used to know in past various vampire-like creatures. According to legends, these creatures sucked human blood, but not sucked animal blood. Unfortunately, because of the fast progress of civilisation, and also because rampaging fascination with new religions, these old "superstitions" from pagan times are quickly being forgotten there. Therefore currently about creatures which used to suck human blood, one may only hear from fast disappearing older people in villages located in jungle. But this usually is connected with a troublesome and long expedition, and also with the need to overcome various organisational difficulties. An example of these can be the need to have an invitation to visit such a jungle village, and also the need to find someone who is enjoying the trust of an older person from this village, and who would recommend us to this older person. This is because without such a recommendation, an older person will be embarrassed to give us any information. In spite of these difficulties, I managed to collect a bit of folkloristic data about creatures from Borneo that suck human blood. These data I am presenting below.

The tribe **Berawan** that lives in the vicinity of Miri from the Sarawak province of Malaysia, calls these creatures "**kokelir**". Interesting aspect of the folklore of Berawan tribe is, that according to it, kokelir display almost all attributes that currently are observed in UFOonauts. And so, these creatures have displayed various magical powers. For example, they can incapacitate without difficulties even the most powerful warriors. For this incapacitating they use "magic" which is very similar to technical hypnosis utilised by UFOonauts. Most frequently they are women with a height of dwarfs. They have extremely long finger-nails. These fingernails are similar to conical metal "rods" attached to end of fingers of Manohra described in subsection R4. Their teeth glows with a ghostly light. In turn their long hair stands on heads like hair of the UFOonaut from Figure R4. Kokelir are able to transform in the sight of people into a black animal of the size of dog with long fur, which in Borneo is called "Binturong". This transformation is identical to the use of modifiers of appearance by UFOonauts, as described in subsections N3.2 and T4. They live in dense jungle. Most frequently they attack alone men preoccupied with activities that cause a lot of noise, and thus

attract their attention. An example of such activity can be throwing down to earth large fruit picked after climbing a tree. The best defence from them is to jump to water during an escape, because they are afraid of water. But what is the most interesting, similarly like this is done by UFO-nauts, they are not only after human blood, but also after male sperm. Thus they spread a huge horror amongst local males. There are known cases, when they deprived testicles the male warriors that they liked especially. But one needs to remember about the possibility discovered in 1990s, that male testicles, or their productive cells, cut out from their carriers but kept alive, are still able to produce useful sperm capable of effective fertilisation. This is because of these dwarfed women seeking after male jewels, the dangerously looking warriors of the tribe Berawan, even when equipped in swords, shields, and blow pipes with poisonous arrows, still were afraid to go alone into the depth of tropical jungles from Borneo.

Bidayuh, means "Land Dayaks". These are people living in the north-west part of Borneo, especially near Kuching. I mentioned about them in subsection A4. Their miniature and very shapely women are famous in the world from their exquisite beauty, gracefulness of movements, and extraordinary skills in love making. Since times of relatively recent accepting Christianity, Bidayuh are very secretive about subjects of their folklore and traditions from Pagan times. Thus in spite of good friendship with many members of Bidayuh tribe, about their version of a vampire I learned only shortly before living Borneo, i.e. in September 1998. They call their vampire a "**sikekak**". Sikekak is described as a women of an average European size. So it is around 170 cm tall, means higher than miniature Bidayuh women. It has an extremely beautiful appearance and long hair that hang down. Most frequently it wears long loose white clothing. It has magical powers. For example, it is able to fly in the air without making a slightest noise, can completely disappear from human view, unexpectedly appear from nowhere, can glide in the air with various parts of the body remaining invisible - supposedly most frequently it is seen gliding without the head, or without the head and hands. This in turn suggests, that it uses the personal propulsion with propulsors in epaulettes - for details see subsection E3. After all, such propulsors form the phenomenon of "magnetic lens" around head and hands of the user. But when it attacks someone, it transforms into an ugly creature with wrinkly skin, huge glowing red eyes with the vertical (like a snake) pupil, clawed nails that stick out to around 7 cm from the ends of fingers, and long fangs which according to legends stick so much from the upper jaw, that they stick several centimetres below the end of chin. It favours attacking men. Independently from sucking a majority of blood from the victims - so that they lose energy completely, the favourite delicacy of it are male testicles. It loves to just bite these testicles out.

Iban tribe of people, locally on Borneo also called "Sea Dayaks", is further subdivided into several large subtribes, the culture of which differs from each other. One of these subtribes of Iban, calls its vampires "**antukuriel**". This name is a combination of two words from their language, namely "antu" meaning "spirit", and "kuriel" meaning "sucking of human blood". "Antukuriel" have the shape of small, dwarfed women, extremely beautiful. They have hair so long that it reaches their ankles. This hair forms a kind of spherical mane around their head, the diameter of which is bigger from the rest of their body. Thus in the general shape they resemble a kind of hairy cone, coma, or tadpole, that is the most wide around the head and narrowest around the feet. They have long, clawed nails, and long fangs sticking out from their mouth. They frequently give out howling noises, which probably are their speech. Supposedly in the melody these noises are identical to commonly known in Borneo calls of Muslim Imams who announce time of prayers from minarets of every active mosque on Borneo. So if somewhere deeply in the jungle Ibans hear this howling noise that does not belong there, then they panic and run homes as fast as they can. "Antukuriel" attack exclusively men. Apart from sucking blood, similarly to "kokelir" they love to eat male testicles.

Other subtribe of **Iban** from Sarawak in Borneo, which lives in the area of Bau, calls their vampires with the name "**antukambak**". According to the beliefs of this subtribe, "antukambak" are small women around 1 meter in height. They have long hair that falls down reaching the ground. Their fingers are very long with fingernails shaped like claws. They are

extremely beautiful. But when they attack someone, they turn into ugly, wrinkled, old females. When they give out a voice, it resembles a chaotic mixture of giggling of a small woman with squeaky voice of a child, with like a howling of Muslim Imam that calls for prayers. When they move, they do not walk like humans do, but they float motionlessly in the air about 25 cm above the ground level. They also are able to fly high in the air. Ibans claim also, that the attribute of their "antukambak" is, that they do not cast shadow. So in the manifesting this attribute of the telekinetic flickering, they are shockingly similar to European vampires, in spite that their external appearance is completely different. They can be seen only by an accident, when they do not expect anyone watches them. When they realise that are observed, then they immediately disappear, or change into an animal. Favourite animals into which they frequently transform, are squirrel and eagle. (We probably remember, that Greek goddess-UFO-naut "Hera", wife of Zeus, by Romans called "Juno", liked to turn into an owl or a peacock - this is probably why owl is a symbol of wisdom.) The most interesting, however, in the folklore of this Iban tribe is, that it believes that "antukambak" actually **feed on the energy** that they drink from their victims, not on human blood. After an attack of these creatures, the human victims become completely lethargic and lose their will to live. On the occasion of drinking this energy, "antukambak" harm their victims in many other ways as well. An example of such harming, is to let blood out and to collect it. "Antukambak" love to play with human blood, especially pour it from one dish into another dish. Also they take out human intestines, remove testicles, and have with humans forced sexual intercourses. All this they carry out only because torturing people gives them pleasure. These descriptions indicate that the behaviour of "antukambak" is actually identical to the behaviour of UFO-nauts.

The above is worth to complement with the information, that **Indians** know a creature very similar to "antukambak", which also loves to torture people. They call it "**ravana**". The anniversary of overpowering this creature by god, Indians celebrate every year as the "deepavali" holiday.

Still another subtribe of **Iban**, that lives in the area of Sri Aman, distinguishes two different versions of vampires. They call these two "**antukuriel**" and "antulakak". But this Sri Aman "antukuriel" is different from the creature of the same name from the area of Syrian, and it looks like Japanese "kappa". It is a male of around 1 meter tall, completely hairless (bold), with the dark skin covered with scales like from a snake or a fish. The food delicacies for this creature are, amongst others, human male testicles. In turn "**antulakak**" from Sri Aman has a very long nose. It looks and behaves exactly like "antukambak" described above.

China. Chinese call their vampires with the Cantonese name "kiong si". Chinese folklore describes "**kiong si**" in a very interesting manner. According to it, these creatures move in long jumps, taking during these jumps positions of body illustrated in Figures E3 and R3. Namely their hands are horizontal like hands of lunatics - either held horizontally in front of them, or spread horizontally to sides, far from the belt. In turn legs are slightly spread. Their jumping movements supposed to be imitated by jumps of children playing bunnies. Unusual detail of Chinese folklore is also, that jumps of these creatures clearly differ from jumps of people. It is because "kiong si" do not bend knees, means they behave exactly like this is the case during the use of magnetic personal propulsion system described in chapter E. This not bending knees, the Chinese folklore even explains rationally. It states that these creatures belong to the realm of dead people, so their body is stiff and cannot bend. But this folklore does not explain why in spite of being so stiff, they still manage to make their jumps.

It is worth to add, that in years 1837 to 1904 in London, **England**, an UFO-naut was raging named "**Spring-Heeled Jack**". He also was moving in similar jumps like these Chinese "kiong si". For example he was able to jump from the level of footpath directly on roofs of buildings. His quite exact descriptions are contained in the voluminous literature devoted to unexplained phenomena. For example in the book **[1R4.1]** by Jerome Clerk, "Encyclopedia of Strange and Unexplained Physical Phenomena", Gale Research Inc., 1993, ISBN 0-8103-8843-X, 395 pages, HC, this UFO-nauts is described on pages 298 to 299. He is described there as a tall man with deviated habits, who had huge, red glowing eyes, large pointed ears,

and who was dressed into a tight costume made of material that resembled white oiled cloth called "oilskin", while on the head he had shiny helmet. Spring-Heeled Jack was able to jump over tall buildings and to make horizontal jumps long for tens of meters. He also clearly indulged in hurting women, scratching them deeply with his sharp like steel claws.

Independently from "kiong si" Chinese know also several other creatures which indulged in torturing people, including into these tortures also drinking human blood. Probably the most known of these are Buddhist "**ogre**". The tradition of "ogre" originates from India, and arrived to China together with the Buddhist religion. "Ogre" were identical to Japanese "oni" described below. Probably "oni" are just a Japanese version of these "ogre". Eastern mythology directly claims, that "ogre" arrived to Earth from cosmos, and that their major occupation was to torment people. However, several out of them "allowed to be converted into Buddhism". Or perhaps Buddha was their cosmic boss - see Figure S7. These become helpers of Buddha. Thus the extraordinary actions of Buddha were carried out just due to the help from these "ogre" and "magical" equipment that they had. These actions included, amongst others, levitation in the air, and instant flights at enormous distances. Curiosity of "ogres" is also, that they lived in long, glossy, underground tunnels and underground caves, identical to these described in subsection O5.3. In these tunnels and caves they used to hide their flying machines, and also hide treasures which they loved to gather.

Europe. Although in subsequent countries of Europe, some details of folklore on vampires may slightly differ, generally speaking their idea in every nation is quite similar. European **vampires** typically have the size and appearance of an average human. However, their especially well known cases, e.g. Drakula, could be of a height slightly higher than normal, and comparable to the television magician David Copperfield. Most frequently they are described as men. But there are also female vampires. Their teeth is characterised by especially prominent fangs. Their teeth supposed to glow ghostly in darkness - see descriptions of magnetic glowing of face and eyes in the UFOonaut shown on Figure R5. They have magical powers to transform into various animals. Most frequently they transform into a dog, a crow, or a bat. So in this ability they are similar to UFOonauts with their modifiers of appearance described in subsections N3.2 and T4. When in a human form, they frequently are drawn with bat-like wings attached to their shoulders, identical to bat-like veil that is a part of personal propulsion system from Figure E4a. Their identification can be easily accomplished by two attributes. Namely (1) they do not cast shadow, and (2) they do not form a reflection in mirrors. Theoretically speaking, these two attributes should also be displayed by UFOonauts, if their personal propulsion system works in the mode of telekinetic flickering.

According to European folklore, the best and already proven in action defence against vampires and against all other supernatural monsters that are hostile towards people, is to eat huge amounts of garlic. As it turns out, these creatures cannot take the smell of garlic. Also helps to go to bed with a ring of smelly garlic placed around the neck. This in turn means, that similarly like in people, the **sense of smell in vampires and in other similar creatures is completely physical** and does not have any magical or supernatural capabilities. For example, they are not able to magically transform a disliked smell of garlic, into some other smell that is pleasant for them.

It is worth to mention, that in Europe capabilities very similar to vampires have also creatures called "werewolves". But as this is going to be explained in subsection R4.2, **werewolves** most probably are animals (griffins), while vampires are thinking UFOonauts similar to people.

India. In India people believe that they have supernatural creatures there called "**pej**", which suck human blood. These are similar to dwarfed people, have large heads, and long, horse-like ears. They may be both sexes, means males and females. Always they attack an opposite sex, means their females attack human males, and vice versa.

Indonesia. Indonesians call their vampires with the name "**kuntilanak**". Indonesian "kuntilanak" are described similarly like Malaysian "pontianak", as extremely pretty women. They have very long hair and long fingernails. They do not have wings, but they "float" or

"glide" in the air without moving legs. The fragment of their bodies in vicinity of feet and belt is usually transparent and invisible for human sight. So this their partial invisibility corresponds to descriptions of personal propulsion from chapter E and subsections R2 and T2, and also to descriptions of UFO-nauts that were actually seen so partially invisible in Chalupy on Hel in Poland - their description is provided in the article [4R2].

Japan. Also Japanese people have their mythological creatures that are hostile to people. One type of these they call "oni" in Japan. "**Oni**" are extremely wide human-like creatures of the height of a large man. But proportions of their body, especially their width, are like in gorillas. Their faces look extremely ugly. They appear in many different races that differ from each other in the colour of their skin. These colours are more decisive and vivid than in humans. For example, there is a race of red-skinned "oni", pink, and also blue-greyish. Their hair forms a kind of mane that grows both on their heads and also around their faces. But the front part of their face is hairless. These dense hair give to their heads the unsymmetrical, shapeless, and deformed appearance, slightly resembling the heads of male lions. Their hair is very curled, dense, and tight, approximately like hair of inhabitants of Africa. The hair makes an impression of almost deformed surface of body. Independently from hair, "oni" have also two clearly noticeable horns on their heads, of the length and thickness of their fingers. Amongst teeth their fangs are striking, two per each jaw. The length of these fangs is similar like in Earthly predatory animals. On hands and legs they have only three fingers finished with long, sharp claws resembling in shape claws in lions and wolves, not fingernails in people. "Oni" also display all "magical" powers that are characteristic to present UFO-nauts. Some researchers claim that there is a race of UFO-nauts that feed on human flesh - see article [3P8]. They describe this race to be very similar to these "oni".

Interesting, that a folklore tradition states that also in **Poland** creatures hostile towards people were known, the appearance of which corresponded to these Japanese "oni". Polish folklore most frequently described these creatures to be devils named "**kurze lapki**" - this translates as "cockerel feet". A known Polish proverb refers to them while it states that "kto nie slucha ojca matki ten slucha kurzej lapki". In the rhymed form this proverb states that "who does not listen to parents, he/she listens to these devils". This name most probably resulted from the fact, that their hands and legs finished with only three fingers, approximately resemble chicken feet.

Independently from "oni" Japanese know also another kind of vampire-type creatures, that they call "**kappa**". Kappa are more intelligent than "oni", and slightly less hostile towards people. They are sizes of 10-year old children. Their dark skin is described as green-grey, and covered like fish scales. Their magical powers, similarly to powers of UFO-nauts, supposed to originate from a "magical" water which they carry in the hole at the top of their bold heads.

Jordan. Citizens of Jordan also believe in the existence of a vampire-like creature that feeds on human blood, and that they call "**sakuna**". Sakuna has all attributes of present UFO-nauts. And so, it is nocturnal. It can disappear and immediately shift into different places. It changes the shape. It is able to immobilise everyone. Jordanians clearly distinguish it from - as they call him "Szejtan", means Satan. According to their beliefs, Szejtan does evil things just for a pure competition with God. In turn sakuna does evil things because it loves doing it, and because it experiences pleasure when is able to hurt someone.

Malaysia. Malays, means one of three biggest ethnic groups inhabiting Malaysia, have two vampire-like creatures that feed on human blood. One of these they call "**pontianak**", while another one - "langsurel". Both Malaysian creatures are described as extremely beautiful women. Their descriptions are similar to Indonesian "kuntilanak". They have very long hair that reach their feet. This hair usually stands on ends as if it is charged electrically. They also have claws-like fingernails. They "float" or "glide" in the air without moving their legs. Their bodies become transparent and invisible near feet and belt. So they display attributes of using personal propulsion described in chapter E and subsections R2 and T2. Very interesting are their eyes. Malaysians describe these eyes as very large. They are at least twice as big as human ones. They also have long, vertical gap instead of the pupil. It is known, that exactly

such eyes has one race of UFOonauts that currently occupy Earth. Just before attacking their victim, "pontianak" and "langsurel" turn into ugly creatures with wrinkled, inducing horror, ugly faces and wild aggressive shape. They attack mainly men and also pregnant women. Their interest in pregnant women is more understandable in the light of UFOonauts exploiting some human females as "surrogate mothers" described in subsection U4.1. Differences between "pontianak" and "langsurel" are described as boiling down to only one anatomical detail - namely the location of their breasts. "Pontianak" have breasts located in front of their body, similar like human females do. In turn "**langsurel**" supposed to carry their breasts on the back of their curved backs, so that these stick out slightly to sides on the height of their shoulder blade. Is it possible that old Malays took for breasts some breathing apparatuses or other devices, that these UFOonauts carry on their backs.

Of course, independently from these vampires that feed on moral energy of people, mythology of many countries knows also creatures that exploit humans biologically on many different manners. Equally well known as vampirism manner of such exploitation is the use of people as unwilling donors of sexual services, and also as donors of sperm and ovule. Independently from "kokelir" that implement quite a brutal form of this exploitation, which depends on taking entire male testicles, Western Europe knows also "succubas" and "incubas", Ireland knows their "changelings", while old Polish folklore knows "zmory" ("mares").

In spite of briefness of the above review of mythical intelligent creatures that exploit people biologically, the message of this subsection is unambiguous. It realises that the folklore of practically every nation in the world knows bandit-like intelligent creatures that in all aspects correspond to present UFOonauts. Also similarly to UFOonauts, motives of these creatures are very far from moral perfection, while their direct goal is the biological exploitation of people. Mythologies and folk wisdom of all nations in the world, for centuries are warning us against these creatures. So it is at least strange, that these warnings repeated for such a long time still failed to inspire humanity to treat them seriously, to look through their intentions, and to undertake self-defense.

R4.2. Blood sucking "mascots" of UFOonauts

Motto of this subsection: "Verdict usually reflects the philosophy of the judge, not the level of guilt of judged."

Vampires and other creatures discussed in the previous subsection represent UFOonauts themselves, who clearly show the presence of intelligence and human attributes. After all, only UFOonauts are interested in "sucking exclusively human blood", or more strictly in extracting from people moral energy that is an invisible kind of live-giving blood. But independently from UFOonauts, already are known blood sucking monsters which also originate from UFOs, but which have clear attributes of animals. When released on Earth, these monsters literally suck blood from their victims. The mainly attack animals, although there are cases known when they also attacked people. According to observations to-date, these monsters are simply "pets" or "living mascots" of UFOonauts. As such "pets" or "mascots" they must be distinguished clearly from UFOonauts themselves. UFOonauts keep them on a similar principle like some people keep cats or dogs. Only that when these "mascots" feel hunger, UFOonauts let them loose on Earth, so that they may hunt something for themselves. After they satisfy their hunger, they are taken again to UFO vehicles, which always wait patiently nearby. For this reason people who investigate these mascots have huge difficulties with documenting reliably, that these mascots in fact do exist.

One of the best known such blood sucking "mascots" of UFOonauts is a creature recently called with a popular name "chupacabra". In 1975, 1995, and 1996, it was let loose many times on a densely populated island of Puerto Rico, where quite a detailed observation of it was carried out. In 1996 attacks of this creature noticed also in several areas of Mexico, on

the area of southern USA (i.e. Miami on Florida, Tucson in Arizona), and in San José, Costa Rica. On Friday, 3 October 2003 one of these monsters was also observed in New Zealand - about what I write near the end of this subsection. Many press articles were published about "chupacabras". This summary of attributes of these monsters is mainly based on the extensive article **[1R4.2]** by Linda Moulton Howe, "Chupacabras - The Mysterious Bloodsuckers", which appeared in bimonthly Nexus (P.O. Box 30, Mapleton, Qld 4560, Australia), issue from June-July 1997, Vol. 4, No. 4, pages 53 to 57. But I utilised here also other sources which were in my disposal. In Polish press the following articles appeared about them: **[2R4.2]** ""Chupacabras - blood suckers" (in Polish: "Chupacabras - krwiopijca") published in Journal Nieznany Swiat, number 9/1998, pages 14-15; **[3R4.2]** "Invisible predators" (in Polish: "Niewidzialni drapieżcy"), Nieznany Swiat, number 11/1998, pages 32 to 34; **[4R4.2]** "Vampire from Puerto Rico" (in Polish: "Wampir z Puerto Rico") from Nieznany Swiat, number 11/1998, pages 34 to 37; **[5R4.2]** "Chupacabras in offensive" (in Polish: "Chupacabry w ofensywie"), from quarterly UFO, number 1 (33), January-March (styczen-marzec) 1998, pages 34 to 42. Unfortunately, not everything that is presented in these articles coincides with my own experience and findings. Thus while reading descriptions that are presented in further parts of this subsection, one needs to remember that for sure there is a number of different races of these blood sucking mascots of UFO-nauts, similarly like people have many different breeds of dogs that mutually differ by appearance and by colour. These races of chupacabras are periodically let loose on Earth by UFO-nauts, so that they can "hunt". In turn on Earth all of them are currently classified into the same group of "chupacabras". But in this subsection I only describe one of these races, which I had a doubtful pleasure to encounter in person in my teenage years.

The current name "chupacabra" used for these monsters was formed in Puerto Rico during a wave of attacks of this creature that took place in 1995 and 1996. This name originates from two Spanish words "chupar" ("suck") and "cabras" ("goats"). But in old times these monsters were also known, only that under different names. For example in 1925 they were observed in New Jersey, where they were called "Jersey Devil". In folklore from Poland they are frequently identified with devils that took shape of dogs, or with so-called "werewolves". In antiquity and medieval ages they were known under the name of "griffins" and presented in drawings as small winged lions standing on back legs. In this subsection I am also going to call them "griffins", although everywhere that I use the name "griffin" I also have in mind the creature now called "chupacabra".

Griffins appear in many races, that mutually differ with size, colour of feather, and various anatomic details (e.g. having or lacking a tail). A number of their subsequent races that UFO-nauts let loose on Earth seems to be almost the same wide as a number of breeds of dogs that currently people keep on Earth. Griffins observed so-far usually were sizes of a dog, with a body long at around 0.6 to 1 meter. They smell quite intensely with mud and wind, thus their presence sometimes can be noticed in darkness firstly by a smell before they can be seen visually. Their appearance slightly resembles a small lion, or panther. Frequently they move on back legs only, in an uplifted position. They have a split tongue like our snakes. Most frequently they do not have a tail, although there seem to be also griffins with a tail. (Perhaps all of them are born with tails, but UFO-nauts cut tails in some of them similarly like people do this to some breeds of dogs.) Their body is covered with something, that in front part looks like a fur, while on the back resembles feather. (I personally believe that these are small feathers.) The colour of this fur/feathers usually is completely black. But in several cases this fur/feather was also patched or dotted in colours: grey, brown, brick-like, and even orange and pink. (Probably from such a pink griffin originates the popular character of "pink panther".) Paws of griffin that end all four lion-like legs look like in an eagle - i.e. they have three large fingers, each finished with a sharp claw of around 5 cm long. But these fingers grow from a thick and elongated foot, slightly similar to human one. Head in profile resembles slightly a head of camel or eagle, with elongated lips and split tongue like in snake. The ears are similar to ears in horse. On the top of head it has something like a large protruding bump or crest. In the head most prominent are

huge hypnotic eyes, which glow vividly with red light. Before attacking this monster stares with these penetrating eyes, hypnotising a victim with them - or more strictly taking a control over victim's mind similarly like a grass snake does it with a frog. During looking into these eyes, they seem to constantly enlarge their diameter. In the back of griffin is something that looks like wings put together. Sometimes these wings-like features seem to have like red feathers sticking out backward at length of around 10 cm from their body.

It was observed, that griffins can fly in air. After they satisfy themselves with blood, they always fly towards a UFO vehicle that awaits patiently nearby hidden from human sight. In order to fly they seem to spread huge wings. But their flight looks more like it was carried out with the use of telekinesis than with the use of laws of aerodynamics. But because observations of flying griffins usually were carried out in poor visibility, it is not absolutely sure whether these are griffins that fly, or UFO-nauts equipped into personal propulsion systems take them away and carry out with them into a UFO vehicle that awaits nearby. After all, costumes of personal propulsion systems of UFO-nauts also have sawn huge wings. According to descriptions, on earth griffins frequently move in a half-standing position jumping on back legs like Australian kangaroos or African vultures - both paws simultaneously. Unfortunately I have not seen my griffin in motion, so I am not able to confirm here this manner of movements. Most probably just because the similarity to griffins (sometimes called devils), a meat-eating kangaroo from Tasmania is called "Tasmanian devil". However, they can also move on four legs, like an earthly panther. Most frequently they spend their time standing motionlessly and passively until their victim arrives. They seem to know the future and know where exactly their victim must pass, and they await in such places obstructing the path. During awaiting they either lie on earth in the position of readiness to pounce, or sit like a dog - frequently in darkness resembling an athletic dog with glowing eyes. If they await on a victim while sitting on a branch of a tree, then they resemble a large owl.

Griffins, similarly like UFO-nauts who have them, are active mainly at nights. Thus they most frequently attack their victims during nights. But there were reported also daily observations. They, or perhaps their owners, have favourite areas of hunt. In these areas they appear periodically for decades. Thus local folklore approximately knows where they can be met. It is worth to take notice of warnings of this folklore, because a person who goes in such areas at nights and alone, risks his/her disappearance without a trace. Their attack is completely different from attacks of our earthly predators. Instead of, like our predators, demobilise a victim by a physical power, and then tear this victim apart, griffins completely rely on a paranormal demobilisation and sucking only blood from their victims, while body they leave untouched. During the selection of the victim they do not take any notice on the physical size, but only on the mental power. Therefore they attack even animals that are many times larger than them, such as horses and cattle. But most frequently they are satisfied with small animals, such as chicken or rabbits, only from time to time enriching their diet through an attack on a dog, goat, sheep, or a person. Their attack is composed of two phases. The first phase is a telepathic attack. It is oriented towards hypnotising a victim. They stare motionlessly with their penetrating, glowing eyes into eyes of a victim and try to take a control over victim's mind. During this activity they look completely safe, and even funny, thus inclining a victim to ignore the danger. If they succeed and their victim is hypnotised, then griffins proceed with the second phase, namely a physical attack. But in case when a victim does not surrender the mind under their control, they give up and seek another victim. Never they try to overwhelm their victim with a physical force, or attack again. In the second phase of their physical attack they jump on the victim, grabbing it with their claws in both pairs of legs. Thus sometimes, independently from two deep holes that serve for sucking the blood, a soft-skinned victims may also have several wounds caused by sharp claws on their paws. After they pounce and hold the victim, they very fast penetrate it with their two (sometimes one) pipe-like stings of a diameter around 7 mm and mutual span around 2 cm. I believe that these two stings are hardened protrusions that stick from their split tongue. But at a present stage of research we do not have data about the nature of these protrusions. (I.e. they also can be pipe-like teeth

similar to these that snakes have. But they would need to be extended forward vertically from the mouth, because this is indicated by the direction of wounds caused by them.) These stings penetrate the body of the victim into the depth of around 2.5 cm. The attack is very fast, completely painless and occurs under hypnosis - so victim usually have no idea what actually happens. Squeezing their lips around the inserted stings like for a kiss, they suck the entire blood through them. So victims of griffins usually have one or two holes from these stings, while in their bodies even a droplet of blood is left. But if their paranormal subduing fails and a victim e.g. manages to mobilise to throw them out, then even if they are already in the process of sucking the blood, they still give up and seek a different victim. The entire attack of griffins and sucking of all blood lasts very short, because for a human idea of the elapse of time only around 30 seconds. Most extraordinary in this attack is, that during it these monsters change paranormally the speed of elapse of time in themselves and in victim. Thus their attack looks like the victim move in a slow motion (see the "state of suspended animation" described in subsection M1), while griffins themselves move with an accelerated speed almost invisible for human eyes. An attack of this monster on an aggressive dog was observed. The dog was used to fight and exceeded the griffin with the power and size. But was unable to defend itself. Before in the slowed down elapse of time it managed to do appropriate defence movement, the entire blood was already sucked out from it. There were also noted cases of attacks of griffins on people. In one of them described in [1R4.2], during just a few seconds that elapsed from the moment when the attacked person managed to throw out the monster, he lost a significant proportion of the blood and then for several days was giddy.

The race of UFOonauts who love to keep griffins, most frequently arrive to Earth in so-called four-propulsor vehicles described in chapters D and Q. These witnesses who observed a griffin frequently report also hearing in vicinity a characteristic humming noise of pillars of field from this vehicle. Furthermore, because the four-propulsor vehicle flies with sonic effects, after an attack of griffin and return of this monster to a UFO, witnesses frequently hear the departure of a UFO and the characteristic sonic bang. When the griffin hunts, UFOonauts patiently await nearby until their pet finishes the feeding. It is also known that for people UFOonauts have very strict rules. These rules demand that UFOonauts always take with them bodies of people that died because of activities of UFOonauts on Earth. These bodies are disposed only in cosmic space - e.g. through burning them in a sun. (In discoidal UFOs there is even a special space distinguished, which has appropriate cells in which human bodies are kept - see internal part of the column "Pm" on Figure P30.) Thus if a person falls a victim of a griffin, his/her body is taken into space, while on Earth no trace is left from this tragedy. For some reasons official statistics are not published regarding the matter of disappearances of people. Perhaps, it is due to manipulation of UFOonauts, who do not want that the society asks questions that force to think. But it is shocking how many people every year disappears in every country without leaving even a slightest trace. From observations to-date seems to appear, that a large percent of these who disappeared without a trace are actually victims of UFO occupation, whose bodies are taken and disposed in cosmic space so that no traces requiring explanation are left on Earth. Perhaps that some part of these victims of UFO occupation, died only to satisfy hunger of griffins. In turn regarding animals, UFOonauts seem to sometime take corpses of griffin victims, while sometimes they leave these on Earth. I personally believe, that UFOonauts took a principle, to take only these corpses which are left in densely populated areas, where there is a danger that someone makes their careful studies and analyses the reason of their death. With this taking away can be explained e.g. a significant number of night disappearances of sheep in New Zealand, or cases of disappearance of these goats in Poland which are accessible from the air. In turn the failing to take in cosmos corpses of some victims of griffins is the source of our present knowledge about these monsters.

I have personal score to settle with griffins. As a 17-years old boy I had a doubtful pleasure of meeting one of these monsters. Without being aware of this fact, most probably I was even hypnotised and attacked by it. But I was saved by one of these extraordinary

"coincidents" which constantly happen in my life and which I described in subsection A4. This "coincident" released me from a deadly kiss of this monster. So if not this miraculous saving, the reader probably would not have now a chance to read this monograph. In turn vapours from body probably would enrich atmosphere of Venus or some other hot heavenly body. Here is the description of my personal meeting with a griffin.

It was one Saturday in August 1963. On the occasion of summer vacation in Poland I was earning some money by organising sport festivals and village dancing. A next dancing I was just organising in a small village, the name of which I am unable to find out from distant New Zealand - so I will provide this name sometimes in the future. This village lied westward from a township Cieszkow. In turn Cieszkow is located around 10 kilometres north from Milicz. The meeting of a local organising committee which was preparing this dancing extended until around 1 at night. So to Wszewilki near Milicz in which I then lived I had to return alone on my bicycle very late at night. Just before my departure, one member of the organising committee, half-seriously warned me: now you must return through wilderness by this road on which haunts. When you are near the top of that hill, be careful. A devil taking the shape of a dog sometimes was seen there. At that time I was a perfect product of materialistic education and I did not believe in any devils, especially if these looked like dogs. So I replied courageously with some joke of the type, that a devil would be very helpful in organising our dancing, so if I meet it I try to catch it. While riding my bicycle in the direction of that hill, I was thinking with amusement about these superstitious people, who probably met some homeless dog and immediately took it for a devil. So with these thoughts I defined my internal attitude. If I was to meet something similar to a dog, without a doubt I was to believe it was a dog.

Either there was no moon at all, or it was covered with clouds, because the night was pitch dark. The road by which I needed to drive was a gravel one and in a part it lead through a wilderness. The more hard path led on the right side of that road. I could ride a bike on this path. While pedalling along this path, in the indicated point of the road I really noticed in light of my bicycle's dynamo a creature that lied on my path. It looked like a black, solid-build dog. I started to look with interest at this creature, in order to see why local people take this dog for a "devil". It was completely black. Only the large and strongly glowing eyes were burning red colour. I explained the unusual glowing of these eyes by reflection of the light from my dynamo in the bicycle. The size and proportions of the solid body it exactly corresponded to a large breed of dogs, which officially are called "rottweiler". But I get to know this breed only in New Zealand. I never met a dog of the "rottweiler" breed in Poland. But the creature had a different snout from a typical dog. It resembled me a snout of a camel. On a top of head it also had a clearly visible protrusion, which I took for a freshly grown bump. Along the entire back a kind of a long flap or a standing mane, slightly similar to an erected comb that is kept on heads of so-called "punks". But I was not surprised by it, because some owners of dogs trim them in very unusual manner. Around a neck a flap of like a skin was noticeably protruding, which presently I suspect that could be an edge of the wings folded tightly along the back. It had no tail. But had four muscly legs, placed like in all dogs that lie on tummy in a readiness to get up. This "dog" lied exactly on the path that I needed to pass and did not look that it intends to give me a way. The position of it resembled to me a dog that intends to play with someone. It kept all four legs on the ground in readiness to pounce. The head was protruding forward and slightly lifted above the ground, like in a goose that prepares itself to attack. But the mouth was closed and did not show any teeth. Its front lips were positioned in a tube in a cute grimace similar to lips of a child that prepares itself for a kiss. Actually this "devil" looked very innocent and friendly. It was like preparing itself for a play. It did not look hostile. Only that these penetrating eyes were sinking through the brain and unpleasantly tingling somewhere at the end of spine cord. If my teachers see mein that moment, they would be very proud of the level of my implementation of their philosophy of teaching. I was an excellent example of the blind belief which they impregnated in school, that everything that exists in the universe i already described in scholarly textbooks.

I watched this monster with the earlier internal attitude, that it must be a dog. Only that it

belongs to an unknown and strangely looking breed. I was not even considering that I am just confronting something completely different, what is not described in scholarly textbooks. In turn with dogs I had a lot of experience, so I knew how to deal with them. This one was not growling and not snarling. Means, it must be in a peaceful mood. So in spite that I confronted an unknown monster - during a deep night and on a complete wilderness, I felt no fear at all. I was not terrified that this monster was sufficiently powerful to tear me apart in a split seconds. Because this "dog" decisively remained on the hard path, I decided to walk around it carefully, so not to trigger its aggressiveness. A soft road disallowed riding bicycle outside of the hard path. So around two meters before I run out this "dog" I stopped in order to walk my bicycle around it. After I stopped, of course the light from my dynamo extinguished itself. An absolute darkness surrounded me. But I still could notice the position of this "dog" by these two red-glowing huge eyes, which penetrated me continually. Making sure that just in case my bicycle all the time was kept between me and this "dog", I stepped carefully to the left side of the gravel road and started to walk my bicycle around the creature. I was not aware then, that close to the left edge of the road a cliff from a deep open cast gravel excavation began, with very steep slopes overgrown with some bushes. So when I was carefully walking around this "dog", rapidly earth tilted under my feet and I started to fall down along a steep slope. I made several somersaults, sometimes rolling over my bicycle, other time painfully feeling the bicycle rolling over me. Finally I stopped on some bush. I still spasmodically gripped my bicycle in hands. Blindly groping my way around I managed to scramble back to the road. The "dog" was not there any more. So I took the bicycle back on the hard path, with a relief confirmed that still it is possible to ride on it, sit on it and pedalled to my home.

In home it turned out that my shirt is completely covered with blood. In addition to scratches, bruises, and tearing of the shirt that are normal for such a fall down, I had also three very deep wounds. Two of them were located parallel to each other and looked as deep pierces made with a thick wire, e.g. barbed wire. They were positioned at my right arm, i.e. from the "dog" side. They appeared in the area and at a height, where on other right hand smallpox vaccination usually is done. The third wound looked like a cut or tearing of the skin with a sharp object or a piece of glass. It was located on a wrist slightly above of the area where a watch would be located is I have it on my right hand. It is surprising, that having such three deep and bleeding wounds, I did not feel a pain, while the existence of these wounds I noted only after the arrival home. Furthermore, the entire my shirt was covered with short sticky feather, with a greyish-blue base and pitch black tops. Because pigeons have this type of feathers that change colour at their length, I come to a conclusion that during my somersaulting I must fall onto some old remains of a pigeon. My unusual state I fast explained to myself with a theory, that the wounds come from a barbed wire fence that I encountered, while feathers originate from falling into a nest of old remains of a pigeon. Both wound on my arm healed quite fast, while the wound on my wrist was septic for a long time and it left a large scar until today.

Soon after the events described here I rode through this road again. But this time during a daylight. So I decided to satisfy my curiosity, and to compare on the spot my theory that I invented to explain the entire event with evidence present in the area. So I searched for the pigeon feathers and for barbed wire. Some kind of feathers I found around 10 meters before the area of my fall down - measuring along the edge of the road. In turn around 30 meters after the area of my fall down - also measuring along the road, I found an old barbed wire fence that run downhill of this slope. But I was unable to explain to myself how I could dip myself into these feathers and fence. After all, I fall vertically down, and then scramble straight upwards. However, the sole fact that there were feathers and barbed wire not far from the area of my fall down I took for a sufficient evidence to rationally explain all mysteries of that night. So I put the matter aside for forgetting. At that stage I did not know, that UFO-nauts have the custom of just such manipulating human behaviour and reasoning.

However, this event refused somehow to be forgotten. As if it still awaited resolving, it get stuck somewhere in my memory - probably because of the intervention of the universal

intellect. The second meeting with a griffin, but this time with only sculptures and paintings, took place around 1980. At that time I was already twice as old. In the meantime I managed to experience, that the world is full of things, which are not mentioned in scholarly textbooks. Together with my colleagues from the Technical University of Wroclaw, Poland, I was then in city Prague from Czech Republic. For tourist purpose we visited the Prague's Castle. Czech kings were seemingly fascinated with griffins, because in their castle there were numerous sculptures and paintings of these creatures. In spite that they presented griffins artistically and in a stylised form, with a shock and surprise I recognised in these sculptures and paintings the outlines of my extraordinary "dog" from Cieszkow. My colleagues had difficulties with taking me away from these griffins and showing also other attractions of the castle. It was then when one of these collisions between the scientific knowledge and life experience took place. As a scientist I could not understand, how it is, that I met a griffin as a boy, while everyone knows that griffins are non-existing mythical creatures that supposedly live only in human imagination. Also from that time I stated to be interested in griffins, and to read about them and about other similar monsters.

The last missing link in the griffin matter was found in 1997 because of a next favourable "coincidence". One of my New Zealand acquaintances send me the article [1R4.2] in a letter. In this article, amongst others, descriptions of the appearance of chupacabra were published, together with photographs and descriptions of wounds on hands of a person who was attacked by this monster. The appearance of this creature presented in the article, corresponded exactly to my griffins. But the highest shock for me was to discover, that also wounds caused by it were exactly corresponding to wounds that I found on my arm after the meeting with the griffins. On the basis of these wounds I come to conclusion, that at the night in 1963 I was actually attacked by the griffin. Only that because of the temporary hypnotising caused by this monster, I was unaware neither of the attack, nor the pain that accompanied it. Most probably when the monster pounced to suck my blood, the weight of its heavy corpse bit me out from the road and down the slope. (This is because until today I do not know how it happens that while still walking along the road I rapidly started to roll down the slope.) When I was somersaulting downhill the slope with the griffin attached to me and sucking my blood, the bicycle that I spasmodically gripped in my hands probably by accident drag the monster out of me. So slightly bruised, the monster probably flown away to seek other victim. This would explain the absence of the monster on the road, when I scrambled back in there. But feathers removed from this griffin remained on my shirt. (Pity that I ignored them and did not keep for researching.) The wound on my wrist would originate from the central claw of the back paw of the griffin, with which it probably was holding itself by my hand during the attack. Two wounds in my arm were not at all from piercing with a barbed wire, as I believed in this all the time, but from stings with which the monster sucked my blood. Because once removed the griffin do not attack again, I could ride my bicycle alive, completely unaware what I just experienced.

Griffins (chupacabras) were presented in this subsection for several reasons. Firstly, people like myself during my youth, who like to travel alone at nights through wilderness, have the chance to meet this monster. This is because if I could meet it, also everyone else can meet it too. So if someone meet one of these creatures, it is worth to know about methods of their attack and what one should do then. (I.e. to not subdue ourselves on the initial stage of hypnotic taking control over our mind. Then, if it attack physically, to throw it out from us as soon as possible.) Secondly the reader should also be aware, that griffins are mascots of UFO-nauts. So they always hunt not far from a vehicle of their owners. Thus if someone notices the presence of a griffin, this means that also a UFO vehicle is somewhere near by and observes how their pet is doing. (If necessary UFO-nauts are also ready to take on the deck of their vehicle and dispose in cosmic space a body of a possible human victim of the griffin. So that for a human investigators no trace is left.) Tertiary, it is vital that readers are able to distinguish between griffins and UFO-nauts themselves. Griffins are like a cross between blood sucking "birds" with lions. They are only animal "mascots" or "pets" of UFO-nauts. In turn UFO-nauts are our relatives from cosmos, who amongst others rob from us moral energy that is

equally vital like blood. Fourthly, it is good to be aware of the existence in far cosmos of monster with paranormal capabilities. These monsters are able to slow down the elapse of time in their victims and to take hypnotic control over them. This gives an idea about a kind of dangers onto which are going to be exposed first people that travel to other star systems. Fifthly, the discovery of an existence of a "bird" that has six protrusions, i.e. four legs and two wings, and which additionally has paranormal powers, frees us from stereotypes in thinking. This is because it reveals that on other solar systems evolution could take a different course than on Earth. (Having six specialised legs is normal also on Earth - consider crabs and insects.) Sixthly, the advancement of griffin from a sphere of completely mythical creatures, into a sphere of a bird-lion that really do exist, puts old mythology into a completely different light. It appears that various extraordinary animals which are present in myths of many countries, such as sphinxes, phoenixes, pegasus, unicorns, etc., are simply mascots of UFO-nauts. Seventhly and lastly, it is good if we start to understand, that having such "mascots" and letting out these mascots on Earth for hunting, says a lot about a brutal nature of UFO-nauts that occupy us. After all, it is a popular knowledge that "pets" are always so selected, that they very closely reflect the nature of their owners. So I am getting goose-pimples on the thought, that UFO-nauts who have this type of "mascots" actually have a complete power over people. (Interesting is, how these UFO-nauts satisfy the hunger of their monsters during long trips throughout cosmic space - do they keep on decks of their vehicles several well blooded people, who then are offered to these mascots.)

There is also one more aspect connected with the topic of this subsection, onto which I would like to draw the reader's attention. It is a scientific significance of griffins, or more strictly their hypnotic methods of attacking. Griffins confirm directly the history of humanity discussed in subsection V3, in this part which states that various Earth's fauna was brought to Earth from several different solar systems. The evidential value of griffins originates from folklore believes, that various Earthly creatures, for example snakes, also carry out hypnotic attacks. This in turn means, that they were brought to Earth on which hypnotic attacking was developed evolutionary. (This is because it was unable to develop on Earth because of too low gravity of our planet - for details see subsection JE9.2.) But because of a scientific ignorance regarding telepathy and hypnosis, our orthodox scientists so-far refuse to admit that such attacks do exist, in spite that they are well known in folklore. As a teenager I watched one day an attack of an ordinary Polish grass snake (in Polish named "zaskroniec") on a frog. All that this snake did, was to open the mouth and intensely look frog into the eyes. When I started my observation, the frog was distant by around a half of meter from the mouth of the snake. The concentration of the snake was so intense, that it did not notice my approach and continued its telepathic attack. Because of this I was able to observe exactly the entire event. In turn the frog behaved in the manner that is unexplainable on the basis of an old concept of monopolar gravity. (As it is known, this old concept denies the existence of telepathy and makes impossible explanation of it.) Giving the loud croaking of terror, which by the way brought my attention to the entire event, the frog was strongly holding back the forward movement with the front legs. But the back legs of this frog were making rhythmic jumps. These jumps gradually led the unfortunate frog straight into the mouth of the snake. Even when the front of the frog already went into the mouth of the snake, back legs still kept jumping thus helping the snake to swallow it easier. So the snake only needed to take the effort of swallowing it. After I observed this extraordinary event, of course I asked Wincenty about the entire event (Wincenty is also mentioned in subsections O2.3.2 and O2.4). He was a walking encyclopedia of folklore knowledge. Wincenty confirmed, that grass snakes hypnotise their victims at a distance, so that they do not need to catch them physically, but these victims get to their mouth on their own. It appears that a telepathic attack is not just something that evolved only on distant star systems, and thus exist only in there, but was also brought to Earthly fauna. Only that an official orthodox science on Earth so-far ignored this phenomenon, probably because it was unable to explain it.

Everything indicates that griffins (chupacabras) also hunt sheep in New Zealand. It should not surprise anyone, because New Zealand is basically a sparsely inhabited country,

where supposed to be around 1000 sheep per each person. In turn griffins (chupacabras) love to hunt in uninhabited areas, sucking blood from sheep and goats far from human settlements. An observation of just such a large creature similar to a black panther but really unknown in New Zealand, was reported on Tuesday, 7 October 2003, at 6:25 pm, in the evening news on channel 1 of New Zealand television. Further details were also provided in the programme "Holmes" that was broadcasted on the same channel at 7:00 pm. Observers took this creature to be a wild "black panther". This New Zealand griffin/panther was seen not far from Mayfield near Ashburton. According to descriptions presented in these two New Zealand TV programmes, the griffin (chupacabra) from Ashburton was very similar to that one which attacked me in Poland. It was a pitch black animal of a size of typical dog from the "rottweiler" breed. It was seen on an uninhabited area near a large group of sheep. Actually these programs suggested that during the last 10 years officially reported was at least half a dozen of sightings of this mysterious monster in various unpopulated areas of New Zealand. But as it emerged from local programs of "talk-back shows" type, actually this monster was seen by many more people who did not file an official report because they preferred to remain anonymous. The last encounter with the griffin was reported not only in New Zealand TV and local radio programs, but also in articles from various newspapers. Two such articles I managed to find. One of them [6R4.2], entitled "Man convinced he saw panther" was published in a newspaper The Southland Times (address: Invercargill, New Zealand), issue from Tuesday, 7 October 2003, page 19. Other article [7R4.2] entitled "Panther-like creature sighted" was published in a newspaper The Dominion Post (email: letters@dompost.co.nz; address: Level 8 Majestic Centre, 100 Willis Street, PO Box 2595, Wellington, New Zealand), issue from Wednesday, 8 October 2003, page A3. Unfortunately, as in every case which may lead to the discovery of a hidden interference of UFO-nauts in human affairs, UFO-nauts immediately went into action and with a typical for them method they quickly neutralised the evidential value of the entire observation of the griffin near Ashburton. So the next day, i.e. on Wednesday, 8 October 2003, the evening news on channel 1 of New Zealand TV, broadcasted at 6:20 pm and repeated at 10:30, contained a statement that the searches for this "black panther" did not revealed any signs of it. (It should not surprise, because footprints of a panther were searched for, not footprints of a "mascot" of UFO-nauts.) In turn the next day, on Thursday 9 October 2003, a next lot of news from this channel broadcasted after 6:00 pm, neutralised the griffin's observation even more by a non-critical repetition of a statement given by some unknown individual. This individual stated, that really an 8-kilo large black wild cat was sighted, not a panther. According to him a lot of such black cats roams wildernesses of New Zealand. Of course, this individual that so authoritatively disclaimed the "black panther" to be just a large cat, actually never saw the monster discussed here, nor did any verification research on the spot. After all, in order to claim what he claimed, this individual should firstly verify on the spot whether there are any footprints or other marks from a wild cat, and also whether it was really possible that a professional driver with a sharp sight, who saw everything from a close range, could take a common black cat for a panther. Also the TVNZ news team should not provide such an obscure and unfair disclaimer without giving a chance to the original observer to defend his observation. Anyway, in a typically unfair and brutal manner that is so characteristic for methods of UFO-nauts, the matter of observation of a griffin near Ashburton was closed down again with hands of TVNZ 1 team. The manner of closing this matter was almost an identical repetition of a manner in which in 1992 UFO-nauts closed a matter of finding of 3 UFO landings near Ashburton - also with hands of TVNZ 1 team. By the way, these UFO landings of 1992 appeared not far from the area in which currently the griffin was seen. (The manner of this neutralising of the evidential value of UFO landings from Ashburton is described in subsection VB4.3.1.) But in spite of typical for UFO-nauts neutralising of the evidential value of the griffin's observation from Ashburton, all the existing facts quite clearly indicate that there in fact was seen this blood sucking mascot of UFO-nauts. Here are the most important facts which certify for the observation of a griffin (chupacabra) near Ashburton:

(a) The **appearance** of a griffin. In the TV programme "Holmes" a drawing was shown which was prepared by one of the observers of this monster. As it turns out, there is a huge similarity of the monster seen in Ashburton to this one which attacked me in Poland. The griffin from Ashburton even had this characteristic bump on the head. Only eyes were slightly smaller than I remembered them in my monster. But I seen these eyes at night, when they were glowing strongly. So I could make an error in estimation of their size and proportions.

(b) **Behaviour** of the griffin. The Ashburton monster behaved like a typical chupacabra. It was firstly spotted as it lied down near a group of sheep, waiting for a victim. A panther would not lie down and await, but it would rather stalk a victim. Furthermore, the griffin from Ashburton is extremely illusive - in spite of numerous sightings no-one managed to photograph or hunt it. A significant confirmation is also a fact, that this monster from Ashburton is seen repetitively in the same area. This exactly corresponds to the habit of UFOonauts that they let their mascot loose for hunts only on several favourite areas.

(c) Unidentifiable **footprints**. To the area of observation of the griffin from Ashburton, a special group of trackers was send. They looked for footprints of a panther. But they found nothing that they could recognise as panther's footprints. In combination with the fact that the monster was actually seen there, this actually means that the griffin left much different footprints, which were ignored by the tracking party because they looked e.g. like bird's footprints not like panther's ones.

(d) Appearing in the **area favoured by UFOs**, which is widely known from frequent UFO observations and UFO landings. An evidential significance has also the fact, that the area in which the griffin was seen, lies on the favourite territory of UFOonauts. Not far from the place of present observation of the griffin, in February 1992 three UFO landing sites were found which were famous in the entire New Zealand. These landing sites are shown on Figure O3 (b) of this monograph. Also the method of neutralising the evidential value of these old UFO landing sites near Ashburton coincides exactly with the method of neutralising the value of present griffin's observation.

(e) Methods of **UFOonauts action** revealed during silencing the entire matter. The most important, however, evidence that it was in fact a griffin, was a manner with the use of which UFOonauts neutralised the entire event. This manner coincided exactly with methods of action used by UFOonauts, that are described in subsection VB4.3.1 of this monograph.

Of course, there is a chance that one day the hunting of sheep by a griffin (chupacabra) from Ashburton become confirmed beyond any doubt. This will occur when someone finds a corpse of dead sheep completely drawn of blood and having two deep stings' holes in the body.

At the end of this subsection I would like to add, that the only goal of presenting the above matters is to reveal the truth. This revealing of truth is the mission of the entire my life. Still, it required a lot of courage to include this subsection into the content of monograph [1/4]. To be honest, for some time I even was unsure whether I should include this subsection, or just ignore the entire matter. This is because in present times personal experiencing by a scientist events that diverge from a textbook normality, usually are taken by the society as a discrediting factor. For example, if Albert Einstein admitted in any of his scientific publications, that he saw phantoms and had visions of the future, then most probably no-one would took seriously his theory of relativity. But in spite of doubts that tried to overwhelm me, I decided to describe the above events as exactly as I remember them. I did this independently of consequences that the presentation of these events may cause. After all, I devote my life to a fight for truth whatever this truth turns out to be. I also implement totalizm, in which the everyday philosophy must not differ from the official philosophy. Furthermore, I have orthodox scientists and my former colleagues in fresh memory, who sometimes privately and confidentially admitted to me that they made personal observations of UFOs. But in public and officially they attacked and voted against any research on these secretive alien vehicles.

R5. Historic descriptions of the use of magnetic personal propulsion of UFOonauts

Subsections A3 and V3 explain, that UFOonauts are present on Earth almost continually since the first planting to Earth, initially life and then humanity. Because of such a long staying on Earth, various historical descriptions of UFOonauts observed while they use their personal propulsion systems, must be present. And in fact, if someone analyses historical sources, it turns out that they are full of data, which for sure represent historical records of UFOonauts that use personal propulsion systems. This data mainly originate from ancient India, Egypt, and Central America, although ancient Greece and Rome also have their messengers of gods that wear "flying shoes", e.g. see Hermes. Unfortunately, all these ancient descriptions are too ambiguous and imprecise to have today any technical or evidential value.

Only the development of print and picture graphics that accompanied printed books, lifted in the medieval Europe the precision, and thus also the evidential value of descriptions recorded then. So these are times when first accurate descriptions of the use of personal propulsion of UFOonauts can be found. Probably the most accurate of these descriptions was prepared by someone named Cyrano de Bergerac of Savinien, France (1619-1655). The first of his records is contained in the "comical story" published in 1656 under the title "Comical History of the States and Empires of the Moon" (the original title: "Historia comique des états et empires de la lune"). Almost the same description of the personal propulsion, plus additionally description of a four-propulsor time vehicle of a small type with propulsors shaped like barrels of cannons, is also contained in his second story "Voyages to the Moon and the Sun" published in 1657.

There is a huge confusion and misunderstanding regarding the matter of these stories by Cyrano de Bergerac. Orthodox literature experts believe that these are simply manifestations of philosophical genius combined with overinflated artistic imagination. But actually, when one analyses them more carefully from the point of view of our present knowledge of UFOlogy, they turn out to be just reports of their confused author from his abductions to two huge UFO vehicles. There is no imagination nor creativity in these reports, but only a straight reporting of whatever UFOonauts show to him during his abductions, explained to him, or planted in his mind. Out of both these UFO vehicles, the surface of the first UFO glowed with a cold telekinetic "extraction glow". Thus it was either taken by Cyrano de Bergerac to be the Moon, or UFOonauts cunningly make him to believe that it is the Moon. In turn the second UFO was probably a time vehicle. This is because it formed around itself a spherical space that glowed in the colour of sun. So it was taken to be the Sun. Experiences during these perfectly remembered UFO abductions so shocked and confused Cyrano de Bergerac, that he had no idea as to how treat them. So he describes them in his stories partially comically and partially philosophically, although faithfully. In order to not reveal to future generations that all these events that he described actually happened in reality, UFOonauts make him to introduce a hero to his stories. However this hero can easily be recognised as himself. Furthermore, UFOonauts make him to not explain that the propelling devices that he describes originate from them, but to charge his hero with the task of manufacturing these devices.

In descriptions of Cyrano de Bergerac, flights of his hero to both UFO vehicles taken to be the Moon and the Sun, were carried out with the use of propelling devices which in this monograph are called "personal propulsion systems". These devices were composed of "glass bottles" filled up with "morning dew". The complete propulsion system was composed of 10 such bottles, in which 8 were attached around the belt of the user, while further 2 were attached to both epaulettes of the user. In trips to UFO vehicles, the hero was accompanied by a creature called "Daemon", means as present UFO research would call him, an "UFOonaut - the abductor and the guide". This UFOonaut constantly lied to the confused hero about every matter that was asked. (So this deprived imagination UFOonaut was an equal liar as present UFOonauts, as all his explanations were untrue, although showed not much imagination and were not very far from the truth.) For example, the principle of operation of personal propulsion,

this Daemon apparently explained in a following manner. When the Sun draws up the morning dew contained in these bottles, it also attracts upward the person to whom these bottles with the dew are attached.

The general appearance of this historic personal propulsion system of UFOonauts, composed of glass "bottles containing morning dew inside", is shown in **Figure R7**. The source publication in which this drawing was found, attributes it to Albrecht Dürer, dated 1493. However, other data suggest, that this old drawing of personal propulsion of a UFOnaut is actually wood engraving that illustrated a story by Cyrano de Bergerac dated in 1656 and entitled "Comical History of the States and Empires of the Moon" (in French original: "Historia comique des états et empires de la lune"). For more details about this illustration see the description under Figure R7, and also the topic presented in subsection R6.

Many sceptical orthodox scientists reading stories of Cyrano de Bergerac, and viewing the above Figure R7, for sure are going to express their doubts, whether these in fact do present a historic observation of personal propulsion system of UFOonauts. They will also express their doubts that stories of Cyrano de Bergerac in fact are reports of a confused person from UFO abductions. In order to counterbalance these doubts, it needs emphasizing, that according to the mathematical theory of probability, these stories contain too many facts that are similar to real UFO abductions, to just be an ordinary coincidence. Let us list here the most important such facts, which in these stories coincide with the real appearance and operation of personal propulsion of UFOonauts, and also with whatever abducted people see and experience inside of UFO vehicles.

#1. Number, location, and appearance of propulsors. The personal propulsion described by Cyrano de Bergerac in fact has 10 spherical propulsors, located in exactly the same places as similar 10 propulsors in the UFOonauts' version of personal propulsion with propulsors in epaulettes - for details see subsection E3 and Figure E4a. The casing of each of these propulsors in fact is a transparent sphere which reveals the content.

#2. Morning dew present in these propulsors. Let us now explain why these spherical "bottles" from Figure R7 were filled up with "morning dew", while they could contain any amongst thousands of substances known to people in 1656. Well, if someone learns present reports from scrutiny of propulsors in personal propulsion of UFOonauts, e.g. the report published in the Polish treatise [3B], then he/she learns about a very interesting observation. Namely in some conditions, fast pulsating magnetic field yield by propulsors used in personal propulsion systems of UFOonauts, causes the intense condensation of water from the air, and thus forms a kind of fog or dew. This fog or dew is clearly visible for an outside observer through transparent walls of the casings of these propulsors. Sometimes it even comes out from these propulsors. Presently we already know, that the appearance of this fog or dew around, and in, propulsors of UFOonauts, results from the ability of magnetic fields of appropriate frequencies to cause an immediate condensation of water contained in the air - as this is described in subsection KB2.

#3. An UFOnaut that transported the main hero to a UFO. This UFOnaut introduced himself as the "Demon of Socrates". Obviously this UFOnaut was planning in advance to impregnate Cyrano de Bergerac with philosophical lies and propaganda. Helpfully, although deceitfully, he explains everything to the hero. Unfortunately, his explanations are saturated with lies and with the philosophical propaganda of UFOonauts. It is worth to know, that every current UFO abduction carried out for propaganda reasons, has also such a UFOnaut that guides and explains everything to an Earthly abductee. As an example see [3B].

#4. UFO awaiting high in the sky and appearing like the Moon or Sun. Actual colours and appearance of these both UFO vehicles, correspond to the known presently descriptions of appearance and colours of telekinetic vehicle and time vehicle.

#5. Evil creatures inside of UFOs. From my research to-date it stems, that if evil UFOonauts abduct someone in an open manner to a UFO, and then allow this person to write down his adventures, they have in this a clear goal of harming our civilisation. In case of the Cyrano de Bergerac this goal is excellently visible today. Namely by framing him into his

incredible fantasies, UFO-nauts induced on Earth various prejudices regarding an idea of intelligent life on other heavenly bodies. Also they did this at the very beginning, when these ideas started to be born on Earth. So UFO-nauts used him to work for them according to their chief doctrine, that **"if you wish to hide a tree, you need to plant an entire forest around it"**. In order to plant these prejudices with his assistance, UFO-nauts staffed him with various incredible rubbish, and then telepathically ordered him to write all this down. So his UFO abductions actually were one long string of lies and theatrical shows. For example, already in the first UFO to which Cyrano de Bergerac was abducted, the crew was walking exclusively on hands and standing on heads. Of course, this is physically possible and easy in conditions of weightlessness of the space. It is also known from other descriptions of UFOs. For example, in this monograph description of the Eden from subsection P6.1 explains, that inhabitants of the Eden used to walk on hands and stand on heads. In the second UFO vehicle, which was a highly advanced time vehicle taken to be the Sun, the crew inside was exclusively flying like birds, using telekinetic personal propulsion systems implanted surgically into their bodies and unnoticeable to an outside observer. They deceitfully explained to the visitor, that they are a society of birds. Because the crew of that vehicle knew that he is going to be killed immediately after he fulfils his collaboratory task, during his visit to this UFO they even arranged for him a theatrical court sentencing, in which Cyrano de Bergerac was openly sentenced to death. (The reason which they gave him for this sentence, was the fact that he is a human. But the real reason for this verdict is described in next item below.) This death sentence was then executed soon after he returned to Earth from this UFO abduction and managed to exactly write down the propaganda that UFO-nauts manipulated into him.

#6. The death of Cyrano de Bergerac at the age of 36. As this stems from my UFO research, if UFO-nauts manage to use someone and make this person to complete an important for them strategic task on Earth, then they murder this person immediately after such a collaborator fulfils his/her obligations. This killing is to prevent the possibility that such a collaborator reverses later accidentally, by telling the real course of events, the fiction that with his/her aid UFO-nauts pushed into our civilisation. And exactly this happened to Cyrano de Bergerac, who died mysteriously at the age of 36 years, immediately after he managed to write down the fiction that was manipulated into him by UFO-nauts. His death occurred even before he actually managed to publish his "fantastic stories". Due to his obedience to manipulations of UFO-nauts, our civilisation from the very beginning gained prejudices towards the idea of life on other heavenly bodies. These ideas were transformed by him to become subjects of scoffing and laughter. It is worth to add here, that Cyrano de Bergerac was not the only person on Earth whom UFO-nauts murdered immediately after he completed the task that UFO-nauts assigned to him. In France we know also Jeanne d'Arc (1412 - 1431). She was burned on the stake shortly after on the telepathic commands from UFO-nauts she helped to take the throne of France by the King Charles VII (1422-61), who belonged to the French dynasty of Valois (1328-1589) known from excessive moral decadency. The immoral tradition that this King and his dynasty spread, was later inherited by the dynasty of Bourbons (1589-1792) and was resisting eradication by even the French revolution.

On the basis of the above, it becomes sure that Cyrano de Bergerac already in XVII century observed or even experienced on himself the use of personal propulsion of UFO-nauts. With the use of this propulsion he was abducted and lifted upwards to two UFO vehicles. The first of these vehicles, because of the size and because of the cold while "extraction glow" which it emitted, was taken by him to be the Moon. The second UFO vehicle was taken to be the Sun. In turn his observations he described later in his stories, especially in the "Comical History of the States and Empires of the Moon" (in French original: "Historia comique des états et empires de la lune"), which later was announced to be a "fantastic story". Unfortunately, the manner in which he presented his adventures was cunningly manipulated into him by UFO-nauts. Thus it introduced to our civilisation many intellectual prejudices against the idea of intelligent life on other heavenly bodies.

Independently from the presentation of a historic personal propulsion system, the above

events contain a warning. Namely, if someone is being used by UFO-nauts similarly like Cyrano de Bergerac, to spread their pro-occupational propaganda on Earth, then for his own good such someone should NOT publish the fiction that UFO-nauts push onto him. Rather opposite, such a person should stick pedantically to facts and describe everything exactly as it happened. Only if he is to report truth from the very beginning, UFO-nauts will not have a reason to kill him before he manages to invalidate fruit of their intrigue with his later corrections of UFO-nauts' original fiction.

R6. Philosophical trap

To complement the previous subsection R5, it is worth to mention here about "**philosophical traps**". These are awaiting in cases of attempts to explain "rationally" old stories and legends of the type listed before. These traps are simply mental stereotypes, that people of our times acquired in the result of present level of knowledge, technology, philosophy, etc., and which without a second thought we assign to people that lived in other epochs. We keep forgetting in such cases, that the knowledge, technology, and philosophy of such people from other epochs, were much different from ours. Thus they thought in a manner completely different than we think today.

A best example of such "philosophical traps" is Figure R7. The origin and meaning of this Figure is quite controversial. But in my personal opinion it presents someone's report from either the observation of a person that used a magnetic personal propulsion system, or from experiences of a person that used such a propulsion system. Everything indicates that this Figure is a wood engraving that illustrated a "fantastic story" by Cyrano de Bergerac published in 1656 and entitled "Comical History of the States and Empires of the Moon" (in French original: "Historia comique des états et empires de la lune"). Some people claim, that this drawing can be explained easily in a "rational" manner, as showing Mr Cyrano himself floating up to the Moon with the aid of "magical bottles - balloons". Such people claim also, that this drawing has no any evidential value, because everyone may drop into an idea of floating in the air with the aid of several balloons attached to the body. Even stories for children, and Disney films, present this means of transportation. Unfortunately by postulating such an explanation, these people just fall into this "philosophical trap" being explained in this subsection. In case of Figure R7 this trap depends on the fact, that the use of several balloons attached to the body as a means of ascending into the air, is characteristic to only present level of philosophy and knowledge. Thus it cannot be extrapolated to people living in old times. If one makes an effort of checking the history of human technology, balloons as means of ascending into the air were invented only at the end of XVIII century. The first unmanned flight of a balloon took place on 4 June 1783, while the first manned flight of a balloon with two people on board, occurred on 21 November 1784. And we must remember that these were flights in a balloon on heated air, not flights in a balloon filled with a gas or a "dew" that is lighter than air. So in times when the story from Figure R7 was published, means in 1656, no-one was able to make fantasies about the use of balloons for ascending into the air, for a simple reason that balloons were not invented yet.

In addition to the above it is worth to add, that the biggest puzzle of this falling into "philosophical traps" is why some people feel such powerful internal urge to explain everything in a manner which they call "rational", even if their explanations are exactly contradictive to the logic and to the present knowledge "in the name of which" these explanations are coined. After all, their need for a "rational explanation" is very selective and limits itself exclusively to topics that in subsection VB5.1.1 are listed as these that are intensely blocked on Earth by UFO-nauts. For example, if someone expressed any opinion contradictive to present knowledge about any subject that is not on the list from subsection VB5.1.1, then almost never anyone in the vicinity begins to correct him and claim something along the lines: "you are at wrong because according to the newest quantum physics or theory of relativity this what you

describe is actually as follows ... (and here would be provided details that correct the original person)". However, if someone provides an explanation which postulates the existence of UFOonauts, UFOs, telekinesis, etc., then immediately someone in the vicinity is unable to hold back, and is emotionally starting to correct and to contradict the original presenter, providing such heavy artillery as "Occam razor", "rational thinking", "present science", etc., - see subsection A3. The only explanation for the existence of this inner need to protest and to correct, is that people in an unaware manner are constantly manipulated with telepathic commands, to vigorously fight against this type of information. In turn all individuals most susceptible to this manipulation, simply are unable to resist these telepathic commands.

Between us, all explanations involving UFOs, including the one presented in subsection R5 that explains the evidential significance of Figure R7, are also fully "rational" and agreeable with the present empirical knowledge. Only that present orthodox fanatics of "rational thinking" are too blinded by telepathic commands of UFOonauts, to be able to notice this.

R7. Summary

The evidence provided in this chapter represents only a small fraction of a huge ocean of similar facts which overflow the files of UFO investigating organizations and the collections of private researchers. If one analyses these facts it becomes evident that they all display perfect correspondence to the expected properties of magnetic personal propulsion described in subsection E6. The logical determination of such a correspondence constitutes formal proof that UFOonauts already use magnetic personal propulsion garments. Completion of this proof introduces numerous consequences, the most important of which are listed below:

#1. The proof confirms the correctness of this part of the Theory of the Magnocraft which describes magnetic personal propulsion. This is because it indicates that operational models of magnetic personal propulsion already exist.

#2. It confirms again that UFOs have a strictly technological origin which results from the advancement of appropriate technical devices. It also reassures us that there is nothing supernatural in the abilities of UFOonauts, and that all of their actions can be rationally explained with our present level of knowledge. Also it reveals further evidence for the rotten morality of these evil parasites from cosmos.

#3. It testifies that UFO manifestations have an extraterrestrial origin, as human technology is yet unable to produce such propulsion devices. Also it provides the theoretical base for the piecing together of further secrets of UFOonauts.

#4. It creates a scientific foundation from which the future completion of magnetic personal propulsion can be launched.

The evidence accumulated in this chapter indicates also that the collection of observational data concerning the personal propulsion of UFOonauts serves a very practical purpose. It facilitates and expedites our completion of these devices.

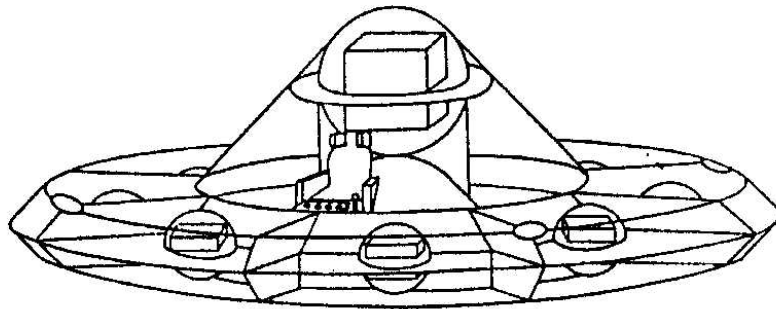
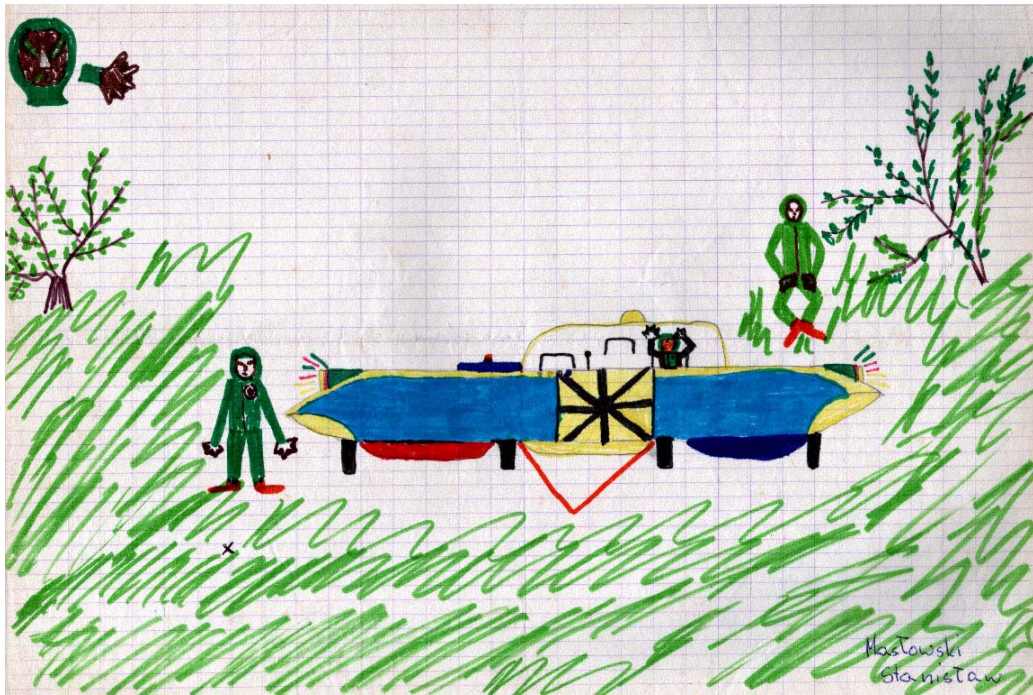

Fig. R1. An illustration of three UFO-nauts and their vehicle drawn by 9 year-old Stanisław Masłowski just after his close encounter in Popowice Park, Wrocław, Poland, on 29 August 1979. In spite of his childish manner of drawing, the vehicle presented by Stanisław very closely resembles the Magnocraft type K3 shown above his drawing in a frame (also shown in Figure F1). The four "black bars" of magnetic field from the UFO's side propulsors are indicated (the UFO apparently landed with a four-circuit mode of operation). The two glaring lamps of the SUB system are also visible on the upper edges of the flange (refer to Figure F30). The two UFO-nauts, wearing tight green suits with hoods and red belts and shoes, left the spacecraft, whereas a third one remained in the crew cabin. The nearest alien hovering in a standing position only about 2 meters from Stanisław has both legs spread apart. The one further back hovered in a squat position. Both these aliens were suspended in the air about 0.5 meter above grass level. The vegetation waved below the thick soles of their shoes. Stanisław noticed that the blood-red hair on the nearest UFO-naut's face and hands stood erect. When the vehicle took off later, the sides of the discoidal UFO dissipated and from the entire base only outlines of the twin-chamber capsule from the main propulsor remained visible to the witness (see the explanation of this phenomenon in Figure F32). Stanisław described this chamber as a device with diamond-shaped outlines (i.e. the effect of seeing a square from an angle), which emitted a strong, dark-yellow light (see also subsection S1.3).

(Upper) The original drawing by 9-year old Stanisław Masłowski.

(Lower) The exact appearance of a UFO type K3 which Stanisław Masłowski witnessed.



Fig. R2. An artist's reconstruction of the appearance of a UFO naut with a glowing belt. The alien was observed in Lindley, New York, USA, on July 23, 1977, just after 1 a.m., by two girls Janine (aged thirteen) and Monica (aged twenty-six) - both surnames are kept confidential. The UFO naut wore a belt from which a green light glowed. He/she also seemed to have a flashlight, and made a tombstone levitate while shining a light on it. Throughout this incident both witnesses got severe headaches, ringing ears, dry throats, and a shortened sense of time (they thought that the three-hour experience had lasted only an hour). All these symptoms indicate that the girls were under the influence of a powerful field emitted by the personal propulsion of this alien.

This illustration is published in the book by [2S1.1] Allan Hendry, "The UFO handbook", Sphere Books Limited, 1979, page 123.



Fig. R3. This photograph is **one of four flash pictures of a very fast-moving UFO**naut, taken by police chief, Jeff Greenhaw, on the night of 17 October 1963, just after 10 p.m. in a remote field west of the town called Falkville, Alabama, USA. In all four photographs the alien keeps his/her legs apart in a motionless, standing position. Because all the photos were taken while the alien was moving extremely fast, this indicates that his/her motion was produced by personal propulsion, not by a physical movement of the legs (stepping). The characteristic stance of the legs spread apart indicates that the alien wore a version of the personal propulsion, having the main propulsors located in the soles of his/her shoes. The UFOnaut was about the size of a large human, and was clad in a silvery suit that looked like tin-foil. Antennae appeared to sprout from the head.

It is worth mentioning here that after taking these photographs, Mr Greenhaw lost his job because the authorities decided that a person who photographed a UFOnaut could not be trusted any more (he is not the only victim of an anti-UFO hysteria).



The tall humanoid seen by Carl Higdon.

Fig. R4. A UFO naut calling himself "Ausso". This illustration presents Carl Higdon's recollection of the alien called "Ausso" who abducted him from the northern edge of the Medicine Bow National Forest (south of Rawlins), Wyoming, USA, on 25 October 1974. It is published in the book [3R1] by Joshua Strickland, "There are aliens on earth! Encounters", ISBN 0-448-15078-6, page 16. The alien was about 1.88 meters tall and weighed approximately 82 kilograms. He wore black shoes and was clad in a black, tight-fitting overall that resembled a diver's wet suit, clasped by a heavy belt with a shining yellow six-pointed star and an emblem below the star. "Ausso" was bow-legged with a slanted head, no chin, and one long appendage in place of each hand. His hair was thin and stood straight up on his head. (I believe that it was because his hair was electrified by the main propulsors in his epaulettes.)

From the point of view of the Theory of the Magnocraft, "Ausso" wore a version of the personal propulsion garment with the main propulsors located in the epaulettes (note the reinforcing braces joining the belt with the epaulettes). At the ends of his arms (i.e. in the appendages) additional enhancement propulsors were located (for aiding heavy physical work) - see Figure E4 "a". From the description available it can be deduced that these enhancement propulsors utilized a technological version of telekinesis.

How M. Ivorde's little man climbed the back wall.

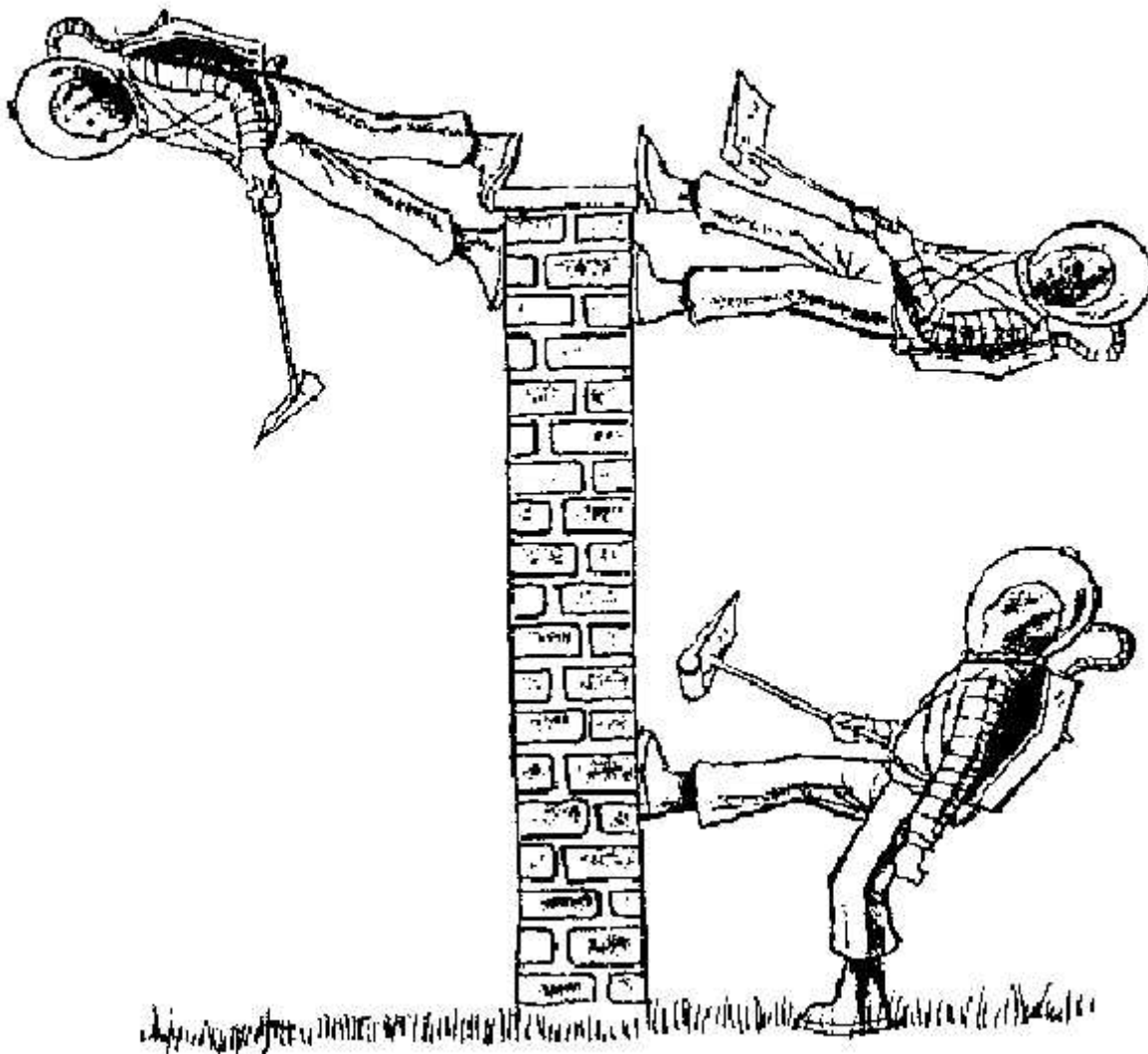

Fig. R5. A UFO-naut climbing a wall. This manner of climbing up (passing) a vertical wall is contrary to our understanding of physical laws, yet M. Ivorde of Belgium observed a UFO-naut doing precisely this. He reported a greenish man about 1 meter high in a helmet and space suit that was seen with what looked like a metal detector. The alien had pointed ears (dog-like) and large luminous yellow eyes surrounded by green rims. When the UFO-naut lowered his/her eyelids, the face, deprived of the glow from the eyes, became invisible. This strong luminescence of eyes confirms that the alien used a personal propulsion system whose powerful field was able to cause the eyes to glow. This means that the main propulsors of this system must be positioned close to eyes, i.e. in epaulettes (compare the reinforcing braces joining the belt with the epaulettes of this being with similar braces shown in Figure R4). When M. Ivorde shone a flashlight at him/her, the UFO-naut walked up a wall in the manner presented in the above illustration (we tend to believe that only insects are able to climb up walls in this way).

This diagram is published in the book [3R1] by Joshua Strickland, "There are aliens on earth! Encounters", ISBN 0-448-15078-6, page 14.

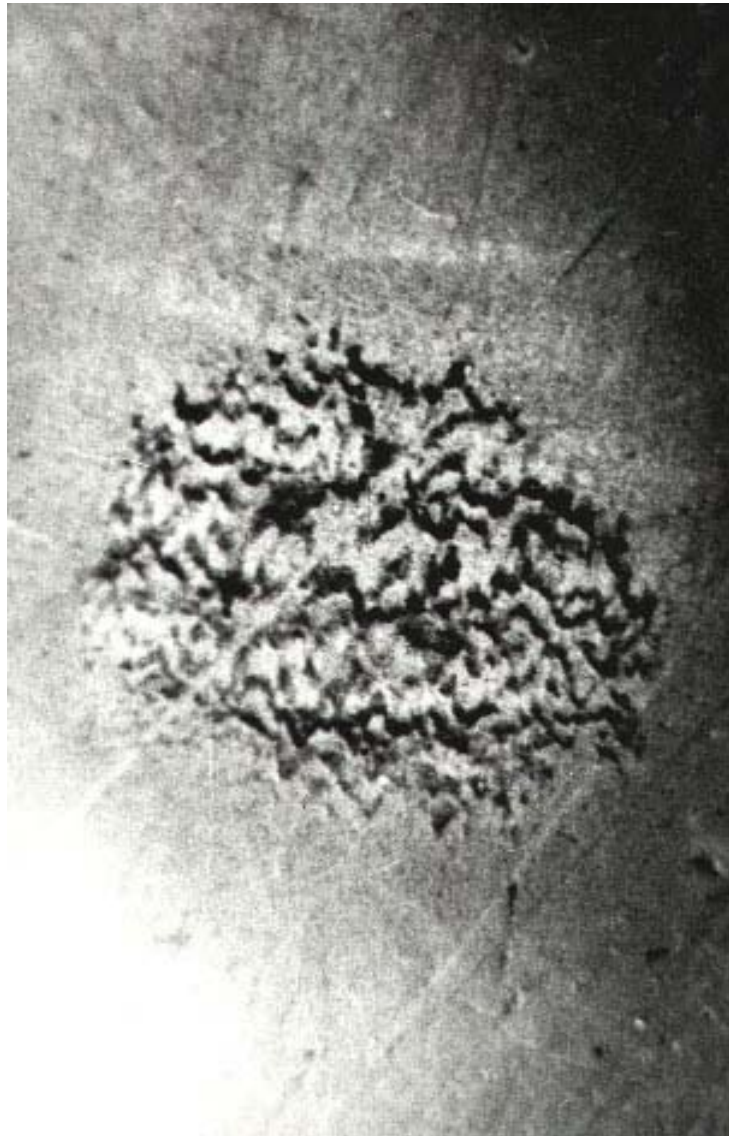

Fig. R6. Footprint of an UFO-naut. This photograph presents one of the seventeen scorched marks left by the main propulsors of an UFO-naut that walked along a PVC floor in the flat of Jerzy Wasilewski (ul. Kruszwicka 53/5, Wrocław, Poland) on 4 September 1979. Each of these marks looked like a chalk-white droplet left on a bluish-grey background of the floor. Marks were (on average) about 13 millimetres in diameter and had a black wavy pattern produced by an active ozone that attacked the PVC particles. All of the marks formed a "footprint trail" leading along a PVC (PolyVinyl Chloride) floor of the flat's inside hall. The relative distance between two successive footprints was about 40 cm. The research completed by a team from the Institute of Inorganic Chemistry of the Technical University of Wrocław, Poland, revealed that the footprints were produced by a highly concentrated pulsating magnetic field acting upon the surface of the Polyvinyl Chloride tiles. Thus these footprints represent conclusive evidence that UFO-nauts use magnetic personal propulsion. To the best of my knowledge, the PVC tiles containing these footprints are still held (together with other material evidence on UFOs) by a UFO investigation group "Wzgórze Partyzantów" in Wrocław, Poland.



Fig. R7. Historic drawing illustrating the use of personal propulsion of UFOnauts. The source and meaning of this drawing remains controversial. The publication that presented it suggested that it was prepared by Albrecht Dürer in 1493. However, other data suggest, that it is a wood engraving that illustrated a story dated in 1656 and entitled "Comical History of the States and Empires of the Moon" by Cyrano de Bergerac, 1619-1655. (Notice from subsection R5, that this story is actually the report from a confusing UFO abduction, that was deformed due to staging theatrical behaviours by UFOnauts, and due to false philosophical explanations that UFOnauts intentionally gave to the abductee.)

Knowing the principle of operation of magnetic personal propulsion with propulsors assembled in belt and in epaulettes, as this is shown in Figure E4a, and knowing that for easy control each one of these propulsors is going to be composed of a transparent twin-chamber capsule assembled inside of a spherical casing also transparent, one can realise what this drawing is portraying. For sure the author of this drawing must see an UFOnaut dressed like a human, and flying in the air with the use of a belt and epaulettes containing these strangely looking transparent spheres filled with something that looked like "dew". But because the only objects that resembled these spheres at that time were spherical bottles, this author interpreted later the flying alien, as a person hang round with bottles full of magical dew. (Notice in subsection R6 descriptions of "philosophical traps" that await in case of a "rational" explanation of this drawing with the use of present stereotypes.)

One of the more precious confirmation that results from the fact, that an UFOnaut shown on this drawing is dressed in the clothing of that epoch, not in a space suit, is that cosmic spies and saboteurs were send to Earth in every epoch, not just only presently - for more details see also subsections VB4.6.1 and V8.1. Due to mixing with the crowd, and looking like every other passer by, these cosmic spies and saboteurs could unnoticeably gather information, which later allowed UFOnauts to enslave humanity more effectively.

Chapter S.**EVIDENCE CONFIRMING THE USE OF THE OSCILLATORY CHAMBER ON UFOs**

In this monograph two groups of premises are confronted. On one hand, theoretical premises are presented in chapters C to F, which highlight the central importance of Oscillatory Chambers for all Magnocraft-like space vehicles. An example of these can be the presentation from subsection F2.2 which reveals that Oscillatory Chambers are placed on both edges of the living compartment, thus practically they must be seen from almost every cabin of the Magnocraft. On the other hand this monograph also contains some empirical premises which show that our planet is continually visited by some extraterrestrial civilizations that already have operational Magnocraft. An example of these is the formal proof addressed in chapter P which reveals that UFOs are already operational Magnocraft. Combining both these groups of premises allows for the proposal of the thesis of this chapter which directly reinforces the main thesis of the monograph. The thesis of this chapter states that: **"The Oscillatory Chamber is already utilized in UFOs as their power source (propulsor) and energy storage"**. The deductions that follow in the further parts of this chapter are to prove the truth of this thesis.

The proof that UFOs utilize the Oscillatory Chamber as their propulsor is easy to provide. It only requires the collecting of evidence that the Oscillatory Chamber is included in the structure of these vehicles, and then arranging this evidence according to the methodology of "matching attributes" already described in subsection P1. Subsections that follow contain such evidence in plenty.

The more difficult task is to prove that UFOs do not use any fuel for their operation, and that their entire energy supply is stored in the form of a magnetic field (i.e. circulating flux) within the arrangements of Oscillatory Chambers called here twin-chamber capsules. To complete this proof it is necessary to provide evidence that the Oscillatory Chambers of discoidal UFOs are in fact arranged into twin-chamber capsules whose circulating flux allows the storage of huge amounts of energy. (Thus also to indirectly prove that the circulating flux trapped in UFOs within their twin-chamber capsules performs the function which is an equivalent to the fuel from "fuel tanks" of our present vehicles.) Fortunately, I have managed to find extensive evidence which documents this as well, including statements of UFOonauts themselves, who confirmed verbally on a number of occasions that the devices which are identified here as twin-chamber capsules, in UFOs perform the function of propulsion and energy storage.

To prove the truth of the thesis of this chapter, I completed large-scale investigations aimed at identifying the evidence required. As a result, numerous facts have been established, all of which indicate the long-standing and continuous use of Oscillatory Chambers on Earth by some advanced civilizations. These facts can be classified into the following categories:

1. Contemporary observations and photographs of the Oscillatory Chambers used in the propulsors of UFOs.
2. Material evidence left on Earth that originates from the Oscillatory Chambers of UFOs.
3. Mythological references to devices which can be interpreted as Oscillatory Chambers.
4. Historic descriptions of devices which seem to represent the ancient version of the Oscillatory Chamber.

The first subsections of this chapter present the evidence from each subsequent category in support of the thesis. The conclusion is presented in the last subsection.

S1. Contemporary observations and photographs of Oscillatory Chambers used in UFO propulsors

According to the previously mentioned proof from chapter P, which states that UFOs are already operational Magnocraft, the most noticeable components of every UFO spacecraft should be the arrangements of Oscillatory Chambers constituting the propulsors and the energy storage for this vehicle. These arrangements should be seen by every human visitor entering a UFO deck, as well as seen by on-the-ground observers of a flying UFO. Moreover, the magnetic field produced by UFO Oscillatory Chambers should affect the environment in a manner that is unique for these devices. The four separate categories of evidence originating from the above sources, which all confirm the presence of Oscillatory Chambers in UFOs, are presented in the subsequent subsections. Notice that in this chapter only the evidence which concerns the arrangement of the Oscillatory Chambers utilized in discoidal UFOs and called the twin-chamber capsule is presented (see the description of the twin-chamber capsule contained in subsections C6.1. and F1). The use of the arrangements of Oscillatory Chambers called spider configurations by UFOs is discussed in chapter Q.

S1.1. Columns of magnetic field yield from UFO propulsors are square in the cross-section

The columns of magnetic field yielded from the propulsors of a UFO must reflect the shape of the device that produced them. If these columns are yielded by Oscillatory Chambers, they must be square in the cross-section. Thus they would differ from the circular columns of the field yielded by any other device that may possibly have produced them (e.g. electromagnets). As it is a relatively easy task to recognize the shape of the columns of magnetic field yield by UFOs, this provides the first opportunity to detect whether these extraterrestrial spacecraft in fact use the Oscillatory Chamber.

The easiest way of recognizing the shape of the field's columns yielded by propulsors of a UFO is to observe the so-called "black bars" formed from this field. (The formation of these black bars is described in subsection F3.4). These black bars must exactly reflect the shape of the field's columns and therefore when these columns are produced by square Oscillatory Chambers they must also be square in the cross-section. The best configuration of UFOs to observe these bars are so-called "semi-attached configurations" and "detached configurations" - see configurations #3 and #4 in Figure F6. So far a number of photographs were already published which show these configurations of UFOs, two of which are shown in **Figure S1**. One of the most clear of these is a series of colour photographs of a UFO configuration flying at a low height, taken on 16 June 1963 by Paul Villa of Albuquerque, New Mexico, USA. Probably the best reproduction of these photographs was published in one of the early edition of the OMNI magazine (most probably a 1979 edition). Some of them were also reproduced in colour in **[1S1.1]** "The Unexplained" magazine, Vol 1, No 1, 1980, page 10; in the book **[2S1.1]** by Allan Hendry (Foreword by J. Allen Hynek): "The UFO Handbook" (Sphere Books Limited, London, England, 1980) page 210; and in the book **[3S1.1]** by David C. Knight: "UFOs: A Pictorial History from Antiquity to the Present" (McGraw-Hill Book Company, 1221 Avenue of Americas, New York, NY 10020, USA, New York - St. Louis - San Francisco, 1980, ISBN 0-07-035103-1) pages 110-111. The UFO captured on Villa's photographs represents a detached configuration formed from two vehicles type K7. The outlines of the lower vehicle, flying in a reversed position, are wrapped into a magnetic lens therefore this lower vehicle can be seen only partially. On high quality copies of these photographs eleven "black bars" which run between the facing outlets from side propulsors of the upper and lower vehicle are clearly visible. Unfortunately, the shape of these bars is difficult to determine from Villa's photographs. But it is quite well described by some eye witnesses as it is explained below. Another good example of a photograph (originally also in colour) of two UFOs type K7, but this time flying in a telekinetic convention, is published in the magazine **[4S1.1]** "The Unexplained. Mysteries of Mind, Space & Time", Volume 1, Issue 1, 1980, page 4. Both vehicles are also joined with

each other in a detached configuration. It is shown in Figure T1.

In the majority of visual UFO observations the shape of the black bars seen at the outlets from propulsors was not determined. However, there is still a number of such cases when the witnesses took special notice of this shape, and remember it exactly. In all these cases the black bars appear to be square. Let us now review examples of such observations the documentation of which has come into my files.

On 12 July 1981 Mrs and Mr Thew (50 King Street, Temuka near Timaru, New Zealand) witnessed two UFOs hovering over their home, which were coupled together in the so-called detached configuration. The observed configuration was identical to the one shown on the photograph from Figure S1. In the Temuka vehicle however, because of a different angle of observation, the shape of the second, inverted spacecraft was not warped by the action of a magnetic lens, and therefore this lower spacecraft was as clearly visible as the upper one. Mrs and Mr Thew saw the black bars and very definitely noted that they were square in the cross-section.

In the book **[5S1.1]** Joshua Strickland: "There are aliens on earth! Encounters". Grosset & Dunlop, New York, 1979, ISBN 0-448-15078-6, page 11 an illustration of the semi-attached configuration of two UFOs which kidnapped a Brazilian soldier named José Antonio da Silva is published - see **Figure S2**. The black bars observed on this vehicle were clearly indicated to be square in the cross-section.

One of the most objective types of evidence confirming the square cross-section of columns of magnetic field yield by UFOs are the scorched marks left on the ground by these vehicles during their landings. Such marks, in this monographs called "UFO landing sites", usually take the shape of a ring with a single scorched patch in the centre. (A more detailed description of these marks is provided in subsection O5.1.) When a UFO lands in an inverted position, the outlet from its main propulsor almost touches the ground. In such a case, if the vehicle's field remains non-whirling, a central mark scorched on the ground by this propulsor must correspond to the shape of a column of magnetic field yield from this propulsor. I have investigated a number of marks resulting from such UFO landings, and in fact have discovered sites which contain a clearly burnt square mark in their centre. An example of such a site is shown in **Figure S3** (compare the central mark from this Figure with the outlines of the twin-chamber capsule shown in Figure A1 "c" and in photograph from Figure S5). The existence of these permanently burnt square marks in UFO landing sites provides vital material evidence in support of the thesis of this chapter.

S1.2. Outlets of UFO propulsors are square and reveal gold or yellow bands of electric sparks rotating inside

The shape of the columns of the magnetic field yielded by UFOs can also be recognized from the observations of layers of ionized air that glows at the outlets of vehicles' propulsors, or from the outlines of the propulsors' contours. The evidence from the subsection that follows documents this aspect.

The most objective source of information regarding the shape of layers of air ionized at outlets from UFO propulsors are photographs of these extraterrestrial vehicles taken in circumstances especially good for capturing the glow of this air, i.e. during photographing from underneath, when the light is dimmed (e.g. in evening), when the air is humid (e.g. tropical) and thus supporting the ionization, and in the case when the vehicle's field is stationary (i.e. non-whirling). A number of such photographs was already published. The best of these is a photograph of a UFO type K3 which on 3 January 1979 hovered motionlessly over Butterworth in Malaysia. This photograph was published in the newspaper **[1S1.2]** National Echo, of Penang, Malaysia, 4 January 1979 edition. It was subsequently reproduced in the **[2S1.2]** Mufon UFO Journal, February 1980 edition, page 8. The original reproduction of this photograph was impossible to obtain, therefore in this monograph I show only the newspaper

reproduction of it - see Figure P15. Unfortunately, from this reproduction it is impossible to determine what shape exactly the outlets from UFO propulsors have (presumably this is because the field of the vehicle was spinning during taking this photograph).

Much better opportunity for determining this shape came from a photograph taken by a New Zealand fisherman named Norman Neilson (Motunau Beach, North Canterbury, New Zealand). On October 1979 he took a slide photograph of his newly-purchased fishing boat. But by chance in addition to the boat he also captured a K5 type UFO in which the areas of ionized air at the outlets from the side propulsors of this spacecraft are clearly visible. His photograph, presented in Figure P16, is similar to the one shown in Figure P15, but the base of a UFO is captured under a slightly sharper angle. A former Air Force photography expert, the late Fred Dickenson of Timaru, New Zealand, conducted some research on the Motunau UFO picture. His enlargements revealed that the columns of a magnetic field yield from the outlets of the side propulsors of the spacecraft display the features characteristic for the square shape in the cross-section. The above mentioned photograph and its enlargement have been published in the **[3S1.2]** "Xenolog UFO Magazine" (New Zealand), no 122, January/March 1980, pp. 10-12.

In the book **[4S1.2]** David Wallechinsky and Irving Wallace, "The People's Almanac #2", A Bantam Book, Inc., New York 1978, ISBN 0-553-01137-5, page 599, there is the description of a landed UFO observed by Mr Gabriel Gachignard, a customs official from Marignane Airport (France). He noticed the square shape of forms which he took to be windows, but which in fact were layers of air ionized by the pulsating magnetic field at the outlets of the vehicle's side propulsors. Here is the relevant quotation from **[4S1.2]**, which describes Gachignard's UFO observation:

"It had the shape of a football, he recalls, with very pointed ends. He estimated the object's dimensions to be 3 ft. high and 15 ft. long {i.e. around 0.9 and 4.5 metres}. The underside was in a shadow, but along the top was a row of four SQUARE windows, from which emanated a pulsating light, ghostly and soft, which changed colours from bluish to greenish in a sort of throbbing pattern."

Note that in this quotation, as well as in all others cited in this monograph, in the wavy brackets {like so} my explanatory commentaries not present in the original text are included.

To make the above quotation more understandable, perhaps it is worth presenting the formal interpretation of this sighting, prepared on the basis of the Theory of the Magnocraft. This interpretation states that because of the prevailing darkness Mr Gachignard saw only the upper surface of two side flanges in a spherical complex formed from two transparent UFOs type K3. (The manner of forming such a complex is presented in Figures F1 and P9, whereas the exact shape of single vehicles that were combined into this complex is illustrated in Figures A1 and F1). This complex was slightly slanted towards the observer, in order to adjust the positioning of its propulsors to the local inclination angle of the Earth's magnetic field. Due to this slanting the outlines of its flange took the oval appearance, similar to a rugby ball. The transparent body of the vehicle, namely its two domes containing crew cabins, was hidden from the sight in darkness. The orientation of the vehicle allowed the witness to see the outlets from four side propulsors (outlets from the remaining four side propulsors were hidden behind the unseen crew cabin of the upper vehicle).

On 20th January 1982, Mr Wayne Lockwood of Wanganui, New Zealand, was momentarily dazzled by a beam of white light emitted from the centre of a UFO hovering over him. It is known from the Theory of the Magnocraft that such a light is produced when the Oscillatory Chamber is turned into a kind of fluorescent bulb (see subsection F1.3). Therefore the outlet of the device which produces this beam of light should be definitely square-shaped. Mr Lockwood looked up to the source of light and noted clearly that it was square in contour. His case was investigated by Mrs Carol Thompson (104 Hillcrest Road, Hamilton, New Zealand) who prepared a report on his sighting.

On 23 July 1981 at 10:30 PM Mr James L. McCabe (49 Highland Avenue, Dover, New Jersey, USA) observed for about 20 seconds a metallic object approaching his home at the

height of approximately 500 metres. On the upper surface of this UFO he noticed some RECTANGULAR-shaped forms which he described as windows or port-holes made of magnifying lenses. They were set back from the surface in two steps similar to graduations. The left form had an irregular band of YELLOW light running down and around the edges of its central part. The description of Mr McCabe's sighting is published in [5S1.2] the April-May 1983 issue of the "CUFOS Associate Newsletter", pages 4 to 5. If to analyse what actually was observed, the McCabe's description of the above forms corresponds perfectly to the facing surfaces of the twin-chamber capsules from the side propulsors of the observed UFO, operating in the mode of inner flux prevalence - see Figure C6 (a). The impression of magnifying and dislocation was probably caused by the light being bent by the circulating flux yield from the outer chamber.

S1.3. Twin-chamber capsules formed from two Oscillatory Chambers are frequently observed in UFOs and even photographed

The central magnetic circuits of ascending discoidal UFOs produce a unique magnetic-lens effect which facilitate visual observation of twin-chamber capsules from the main propulsors of these vehicles. This effect allowed a number of outside witnesses to see and to precisely describe twin-chamber capsules in UFOs, and to even photograph this capsule on numerous occasions (see Figure S5). The mechanism involved in producing this magnetic-lens effect is the subject of explanations in subsection F9.4.1 and it is also illustrated in Figure F32. But because of its evidential value in deductions from this chapter, for the consistency of presentation this effect is also briefly summarized below.

In ascending UFOs the power of the magnetic field involved in a vehicles' central magnetic circuit exceeds many times the power involved in the main and side circuits. For this reason force lines of the central magnetic circuit hermetically surround not only the entire body of such an ascending UFO, but also its main and side magnetic circuits, which became wrapped in a kind of magnetic donut. Principles involved in the formation of this donut are illustrated in Figure F32. As this was stressed in subsection F9.4, the extremely concentrated magnetic field of a UFO interferes with light. This interference in general depends on allowing the light to pass easily along the field force lines, but bending paths of the light which tries to pass across these lines. The mentioned magnetic donut formed around the ascending UFO means that to reach the vehicle's shell the light would need to pass across the donut's field force lines. But in order to reach the main propulsor, the light would need to follow these lines. For this reason, the outside observer who witnesses an ascending UFO can easily see a twin-chamber capsule from the main propulsor, but he/she is unable to see any other part of the vehicle's shell.

Stanislaw Maslowski of Wroclaw, Poland, was the first UFO observer who drew my attention to this magnetic-lens effect. He witnessed a UFO which took-off from ground level. While watching it rise, to his astonishment he noticed that the entire body of the vehicle gradually diminished and only a small diamond-shaped device (i.e. a twin-chamber capsule from the main propulsor) in its centre became visible. Below is provided a description of his sighting.

On the 29th August 1979 at about 7 PM, 9 year old Stanislaw Maslowski of Wroclaw, Poland, encountered a K3 type UFO in the Popowice Park of Wroclaw. The object was hovering at a height of about a half a metre, and two (out of three) members of its crew had left the deck. The witness came to the vehicle at a distance of about 6 metres, approaching the nearest UFO-naut at a distance of about 2 metres. The encounter took about 10 minutes and provided numerous technical details of the object and its crew. Afterwards, Stanislaw observed this UFO taking-off. When the vehicle only slightly increased its height, the body of its shell began fade away, although the UFO was still too close for Stanislaw to lose his clear visibility because of the distance. Simultaneously, exactly in the centre of the former body of this

ascending vehicle appeared a much smaller device emanating a strong, dark-yellow light. Stanislaw described the shape of this device as resembling a "diamond" he saw on playing cards (i.e. a diamond is a shape which is obtained when one observes a square from an angle).

After Stanislaw Maslowski revealed the existence of the above effect, I began collecting other evidence. The analysis of the evidence accumulated so-far leads to the conclusion that the majority of witnesses who see and describe a square, rectangular, or diamond-shaped UFO which emits from the inside a strong, gold or yellow glow, in fact do not see the whole vehicle, but only the twin-chamber capsules from their main propulsors. The additional confirmation that these rectangular objects represent the arrangements of Oscillatory Chambers, not the entire vehicles (e.g. four-propulsor UFOs similar to those described in chapter D) is the unique glow of gold electric sparks always emitted from inside.

A good example of a typical sighting of a twin-chamber capsule from the main propulsor of an ascending UFO is the observation by Mr Wayne Hill of Invercargill, New Zealand. A drawing of the device that Mr Hill observed is presented in **Figure S4**. This is how he describes his sighting:

"It was about 11:30 PM, on 20th December 1978, shortly after sunset. I was having a walk alone along a road about 7 kilometres south of Nelson, New Zealand. The road in that place runs exactly in the south to north direction. I was walking northward. Rapidly, an uneasy feeling of being followed made me look up. Above my head, at a height of about 30 metres, a lit diamond-shaped outlet having the edge of about 10 metres, was silently passing through the sky. It was flying from south to north. Then it stopped moving and hovered above me. I noticed the edges of an outer cube, lit up by a kind of glow. In the centre of this lit cube, a face wall of another black one was visible. Between the edges of both cubes I noticed a strong yellow glow, which seemed to be more concentrated in the corners of the diamond. I had the impression that this glow came from a filament of a square bulb. The remaining, non-glowing space between both cubes was greyish in colour. Behind the edges of the outer cube I did not notice any remaining parts of a vehicle. My observation lasted only about 20 seconds. After this time the vehicle begin to ascend sharply and then disappeared from my view into cloud."

Sightings of twin-chamber capsules from the main propulsor of ascending UFOs constitute a large portion of all UFO observations. For example, such a sighting was the blueprint for shape D/7 drawn in Figure P8 of this monograph. It is also described in page 93 of the February 1982 issue (Vol. 4 No. 5) of OMNI magazine. Furthermore, the description of a UFO type K3 sighting, presented in the book **[2S1.3]** by Raymond E. Fowler: "Casebook of a UFO investigator, a personal memoir". Prentice-Hall, Inc., Englewood Cliffs, New Jersey, 1981, ISBN 0-13-117432-0, page 133, and discussed in subsection J2.9 of monograph [1], also reveals such a twin-chamber capsule.

The most objective documentation of twin-chamber capsules from ascending UFOs is provided in their photographs. A number of photographs of these capsules have already been taken, although their authors do not realize what their pictures reveal. Two examples of such photographs are shown in **Figure S5**. The first of these (left) taken during the day in Hawaii by a teacher, represents one of the best colour photographs of a UFO twin-chamber capsule working in a mode of "inner flux prevalence". It was published in the book **[3S1.3]** "Into the Unknown", Reader's Digest, Sydney, Australia, 1982, ISBN 0-909486-92-1, page 315. In the better quality copies of this photograph the cone of the magnetic field under the inner chamber is clearly visible. This cone hides the outlines of two further back edges of the capsule. The field looped into the circulating flux acts like a "black hole" creating the black space visible at this photograph. Because of the action of a magnetic lens effect described at the beginning of this subsection, apart from the twin-chamber capsule from the main propulsor of this vehicle, the rest of the vehicle of course remains invisible to the camera. Note that the other part (right) of Figure S5 shows also a night photograph of the UFO twin-chamber capsule operating in the mode of "outer flux prevalence". It was taken on 23 January 1976 above Clovis, New Mexico, USA, by a journalist. It is published in the book **[5S1.1]**, page 49. On this photograph the

resultant flux is produced by the outer chamber. This flux ionizes the air, therefore in the photograph it is visible as the verge of a glowing diamond (the second half of the diamond is emitting its light along the field force lines spread in a different direction, therefore it is not captured on this photograph). The inner chamber is producing the circulating flux which appears in the form of a black diamond which blends equally with black night environment.

In order to be able to recognize the meaning of both these photographs, it is necessary to know about the action of the UFO's magnetic lens (explained at the beginning of this subsection) and also to know the characteristics of the twin-chamber capsules in their "inner flux prevalence" and "outer flux prevalence" modes of operation (these characteristics are illustrated in Figure C6 and discussed in subsection C7.1). Of course, for the researcher who is well acquainted with the above scientific foundations, the photographs of UFO twin-chamber capsules are the source of numerous data allowing to verify the correctness of the Theory of the Magnocraft. For example, both photographs shown in Figure S5 document that the equation (C9): $a_o = a_i \sqrt{3}$ is correct and the proportions of the dimensions that it expresses are really met in twin-chamber capsules from UFOs.

S1.4. Oscillatory Chambers have been seen on the decks of UFOs as described by numerous abductees

Probably the most important source of evidence that UFOs already utilize Oscillatory Chambers originates from the reports of people abducted on the decks of UFOs - for details see chapter U. While being taken on the deck of a UFO, they have an opportunity to observe at least two types of Oscillatory Chambers, i.e.: (1) taking the form of twin-chamber capsules utilized by UFO-nauts as various tools, and (2) taking the form of twin-chamber capsules used as propulsors of a given UFO.

A large proportion of people abducted on the deck of a UFO describe telekinetic twin-chamber capsules used by UFO-nauts as various tools. The best example that I encountered in my research to-date, is a New Zealander with initials R.B. (he expressed the wish that his name is not revealed) who visited a compartment on a UFO that we would describe as a "medical surgery". While there, UFO-nauts demonstrated to him a huge cabinet literally packed with tens of telekinetic twin-chamber capsules similar to semi-transparent crystals of the size of an average handle for a screwdriver. Each of these capsules represented a medical instrument for a different application. After being picked up, they make the impression of heavy crystals with perfect, regular, symmetrical shapes, smooth surfaces, and pleasant, cool feeling in touch. The triggering of their operation occurred after their side walls were squeezed. When squeezed they emitted from the front a telekinetic beam having the ability for almost instant healing of a given type of medical problem (some of them simultaneously produced also a narrow beam of the strong, laser-like light). The abductee R.B. was so impressed with the demonstration of their instant healing effects that later he filled up his flat with ordinary crystals (i.e. made of minerals appearing on Earth) from which he now stubbornly tries to squeeze similar healing properties.

In the effect of the intensive search to-date I have also collected a number of reports describing Oscillatory Chambers used in UFO propulsors. Each one of these originates from a different, independent witness. But all of them seem to describe in detail the same device whose properties correspond exactly to the envisaged appearance and operation of the Oscillatory Chamber. Let us review the key information from these reports.

The greatest luck in respect of seeing the Oscillatory Chamber was had by nine-year-old Gaynor Sunderland, who observed this device twice: once as an outside witness of a landed UFO and next time as an abductee on the deck of a UFO. The description of the device that she saw is contained in **[1S1.4]** J. Randles & P. Whetnall, "Alien Contact", Neville Spearman Ltd., Suffolk, Great Britain, 1981, ISBN 85435-444-1, pages 9 to 13, and 76.

The first of the mentioned encounters took place in Oakenholt near Flint, North Wales,

England, one afternoon (around 2 PM) on a Saturday in July 1976. The girl observed a landed UFO (probably K4 type) from a distance of about 30 metres. On the top of this vehicle she noticed a cubical device visible through the transparent topside dome - see Figure A1. Its attributes and the location suggest that it was a twin-chamber capsule from the vehicle's main propulsor. Quoted below is Gaynor's description of the vehicle and its mysterious device (see [1S1.4] page 9):

"The object was flat at the bottom with a kind of rim surrounding it. It glinted silvery in the sunshine as if made of metal or tinfoil, and stretched about thirty feet {9 metres} from rim to rim, rising to a shallow dome of about ten feet {3 metres}. On top was a small, square box - dull red in colour."

Four pages later (i.e. on page 13) the UFO prepares itself for a departure. The cubical device is mentioned again:

"Immediately the red box on top of the dome began to flash brightly, on and off. It was apparent that preparations for departure were being made."

At this point it is worth mentioning that the description of a cubical twin-chamber capsule of a UFO, almost identical to that of quoted above, was sent to me by Mrs. Christa de Vries (Eichendorffstraße 2, D-2903 Bad-Zwischenahn, Germany - Europe) in her private letter dated 10 March 1992. In 1979 she was driving alone on a lone road crossing an unpopulated area. She noted a UFO which for a significant part of her trip was flying parallel to her car along the side of the road. During that incident she had a good opportunity to observe the vehicle that accompanied her so willingly. One of the details visible through the transparent shell on the top of this vehicle was a fascinating cubical device emanating flashes, which looked as if having a spinning fire locked inside of it. The positioning of this cube in the centre of the UFO, as well as its appearance, suggest that it was a twin-chamber capsule used in the main propulsor of this vehicle.

Returning now to the previous report taken from [1S1.4], on page 76 of the same book there is a report of Gaynor's September 1979 abduction on the deck of a UFO. Again she saw the main twin-chamber capsule of this vehicle, occupying the centre of the crew cabin. Here is its description:

"In the centre of the floor ... stood an octagonal object in a box. It looked like a crystal with plug sockets and wires leading from it into one end of the wall. She was told that this crystal generated the power needed by the object to move, although how was not explained."

At this point it should be emphasised that the above description presents an extremely rare observation of octagonal Oscillatory Chambers of the second generation (see subsection C3.1). Thus most probably Gaynor was abducted onto the deck of a UFO of the second generation (i.e. the telekinetic vehicle). In the corner of the cabin, where all wires led to, most probably a log-computer which controlled the flight of this UFO was placed.

In December 1979 a New Zealand citizen was taken on a UFO deck for some genetic experiments and a medical examination. This person asked me not to reveal her real name, thus in this monograph she is referred to as Miss Nosbocaj. After the completion of the examination, as usually in such occasions, the UFO doctor proposed the abductee a guided tour around the spaceship. One of numerous attractions Miss Nosbocaj observed during the tour was a fascinating device in the shape of a cubical block, rock, or crystal. It was glowing strongly and emitted countless lightening flashes. A view of it was provided from every compartment of the spacecraft. Two years after the abduction Miss Nosbocaj provided a detailed report of her observations. A full copy of her report given during the first series of investigations under hypnosis, is provided in appendix Z. Here is the description of the mysterious device in the shape of a regular crystal, repeated from the verse N-90 of the appendix Z, quote:

"... there's a big cylinder going right down the middle of the spaceship; it looks like it's made out of crystal or something but I'm sure there's some big white glowing block or something in there. That's got something to do with power, lightning or something."

In the next stage of touring, the alien guide explained (see verses N-98 of appendix Z),

quote:

"The whole universe revolves on the positive and negative, that is, that is our power, that is how we fly, using the positive and negative ...".

While reading this report, it is difficult to imagine a better description of the central cylinder of a UFO together with its main propulsor, (see 3, 13, and M in Figure F5) given by a non-trained observer.

In January 1985 I met Miss Nosbocaj personally. As a result of this meeting a number of further details on the device utilized by UFOs was revealed. In the January meeting, again the information was confirmed that the crystal-like device she saw suspended in a vertical transparent cylinder running through the centre of the vehicle was used by this UFO for propulsion and energy storage. It had the shape of a precisely cut crystal or transparent chamber, with flat, shiny, rectangular walls and perfectly regular shapes. Along the inner surfaces of the device golden streams of flickering sparks zigzag horizontally. The thickness and pattern of these sparks reminded the observer of the "system of veins on the hand of an overworked person".

The most evidential and informative sighting of the UFO Oscillatory Chamber is contained in [2S1.4] Raymond E. Fowler, "The Andreasson Affair, Phase Two", Prentice Hall, Inc., Englewood Cliffs, New Jersey 07632, USA, 1982, ISBN 0-13-036624-2, page 69. This sighting is part of the report from Mr Robert Luca's medical examination conducted on a UFO deck. This is how he described his observation (the description quoted is reproduced by kind permission from Mrs Betty A. Luca, copyright holder):

"Then there's a box on the other side that's behind this bench and I can see from standing. It looks like a glass cube and it fascinates me 'cause it's filled with, looks like black smoke. It looks like there's lightning inside it or something gold. Looks like it has streaks of gold running all through it - a bright, bright gold. It's a cube, maybe not a yard square. No, it's less than three feet and it's got all little lightning bolts inside it. It's all black with these gold streaks running through it. It looks like the lightning has been frozen right in its path."

Figure 13 from [2S1.4] presents also the reconstruction (drawing) of the appearance of the above-mentioned cube, prepared by Mrs Betty A Luca. This reconstruction is reproduced in **Figure S6**. The drawing corresponds exactly to how we envisage the future appearance of the Oscillatory Chamber (compare Figures S6 and C3). Notice that although UFO propulsors utilize twin-chamber capsules, instead of single Oscillatory Chambers, because of the mode in which this particular capsule operated (i.e. inner flux prevalence), the outlines of the inner chamber were unrecognizable to the witness behind a black bar of the magnetic field (see also Figure C6).

In answer to my inquiry about how the assumed appearance of the Oscillatory Chamber (shown here in Figure C3 "a") corresponds to the cube sighted by him on a UFO deck, Mr Robert Luca replied:

"Yes! Your Fig. {C3} illustration looks very much like what was seen."

His wife, Mrs Betty A. Luca, in her private letter to me dated on 4th March 1985 supplemented the above description with the following data:

"There is a second book {[3S1.4]} called, "The Andreasson Affair". This pertains to my 1947 encounter. I did see a hatch (square with rounded corners) that had wind and lightning coming out of it. It appeared to be in suspended animation. This was their stored energy. At the bottom (after the wind and lightning was withdrawn) I saw four coils and one hollow cylinder. At the other end of the hatch (coming from the curved wall) I then saw the square like device pulled partially out of the wall. The outer edge was sort of honeycombed. Inside had thin protruding stems with tiny glass droplets on the end. There were also clusters of needle wires pointing outward."

One may wonder at this point if it is possible to receive a more precise description of a twin-chamber capsule from an untrained observer who has never seen it before and who does not know the theory behind it.

S2. Indirect confirmations that UFOs use Oscillatory Chambers

The evidence collected in previous subsections probably represents only a small fraction of the vast amount of facts spread amongst various publications, which directly document that UFO vehicles already utilize Oscillatory Chambers in their propulsors. The identification and revealing of this evidence turned out to be a slow process, as it involves a lot of research.

In the process of searching for direct evidence, I have encountered some indirect evidence as well. This indirect evidence also leads to the conclusion that the Oscillatory Chamber is used in UFOs. But this conclusion is not obvious and must be reached by logical deduction. However, because the use of such indirect evidence in the proof concerning UFOs could be the subject of criticism on the part of sceptically inclined investigators, the presentation of facts belonging to this indirect class will be omitted (after all the direct evidence already presented here well suffices to prove the thesis of this chapter). But to give readers some idea as how consistently these facts support the main thesis of this chapter, the main groups of them will be named. These groups are as follows:

(1) Numerous observers noted that a magnetic field of UFOs does not attract or repel ferromagnetic objects. As it is explained in subsection C7.3, only the appropriate arrangements of Oscillatory Chambers can produce such a non-interacting (antigravity-type) magnetic field.

(2) No one observed any products of "combustion" which in the case when UFOs produce their energy from some kind of a fuel would need to be exhausted. Furthermore, no device which could serve for the burning of fuel and producing energy was observed on UFOs. This in turn means that the reserves of energy in these vehicles must be accumulated in the form of the circulating flux in their twin-chamber capsules, not carried by them in the form of fuel.

(3) UFO crews never mention that a fuel supply is required for their vehicles, or that they produce energy during the flight through burning a fuel. Although the same crews frequently mention that the cubical devices (twin-chamber capsules formed from Oscillatory Chambers) witnessed in their spacecraft store their reserves of energy - see subsection S1.4.

S3. Material (hard) evidence left by UFO Oscillatory Chambers

The evidence described in subsection S1 can be called the "court-type" (or "soft"), as similar type of presentations on many occasions are used in our courts to decide about the life or death of an accused. However, in addition to this, there is also a wealth of material (or "hard") evidence available which can be investigated in scientific laboratories. This "hard" evidence similarly well confirms the use of Oscillatory Chambers in UFOs. So-far I managed to identify two different categories of this hard evidence. The first of these are square marks scorched on the ground by outlets from the Oscillatory Chambers installed in UFOs (these marks were already discussed in subsection S1.1. and illustrated in Figure S3). The second category includes parts of Oscillatory Chambers worn-out during exploitation, and thrown out by UFO crews after replacing them with new parts.

An example of such worn-out parts of UFO Oscillatory Chambers are needle-shaped electrodes found in the USSR. The presence of such needle-shaped electrodes inside of UFO Oscillatory Chambers was for the first time reported by Mrs Betty A. Luca, in her letter to me quoted in subsection S1.4. Unfortunately, her finding would have remained unrecognized, if Mr Ryszard Zudzin of Poland had not discovered during his experiments that in order to make the Oscillatory Chamber operational, needle-shaped electrodes must be used (see Figures C2 and C13). Mrs Luca's report and Mr Zudzin's finding reinforce each other, helping to establish that UFO Oscillatory Chambers utilize conductive needles for their electrodes. In turn establishing this, alerted me to evidence indicating the

connection between conductive needles and UFOs. In fact he found material evidence documenting this connection. It is described in the book **[1S3]** Jack Stoneley, "Tunguska: Cauldron of Hell", A Star Book, A Howard and Wyndham Company, 123 King Street, London 1977, ISBN 0-352-39619-9, page 148. Here is the relevant quotation:

"Zigel talks of another form of UFO 'left-over' found by geophysicist Alexander Zayekin at Tambov, south of Moscow. He calls it 'space tumbleweed' and claims it contained 'intertwining metal needles each about five to eight centimetres long and a half a millimetre in diameter'. 'The needles,' he goes on, 'were of an unknown brittle, grey-coloured metal'."

It seems that at Tambov a UFO crew changed the worn out electrodes from the Oscillatory Chambers of their vehicle, and afterwards threw away or forgot the packets of old, damaged electrodes.

S4. Mythological descriptions of the Oscillatory Chamber

The most recent UFO evidence, as presented in all proceeding subsections, is not the only source of descriptions which document the use of Oscillatory Chambers by UFOs. Independently from this, there is also available a wealth of much older evidence suggesting the use of this chamber on Earth practically throughout the whole history of the mankind. This antique evidence originates from two different sources, i.e. mythology and historic descriptions. If the origin of given descriptions can not be identified, and their propagation occurred via oral passing from generation to generation, we will classify them here as mythology. Whereas if given descriptions originate from some written records the authorship or the source of which can be defined, then in this monograph they will be classified as a historical evidence. The description that follows is to present an example of mythological evidence for the use of Oscillatory Chambers in UFOs, whereas samples of the historical evidence for this use will be provided in the next subsection (S5).

The mythology of many nations contains legends that describe a magical device in the shape of a cube that can be interpreted as the Oscillatory Chamber. One of the best legends of this kind that I encountered so-far is contained in Chinese mythology. It tries to explain the reasons for a series of great sea floods that in 13th century troubled the south-east coasts of China (as well as coasts of New Zealand, Philippines, Korea, Japan, Europe, North Africa, etc.). The more accurate discussion of these sea floods is contained in a separate monograph [5/4]. The legend presented here was told by Mrs. Lee Kong Fah (279 Lorong Setia Tujuh, Air Keroh Heights, 75450 Melaka, West Malaysia), the God Mother of one of my students from Malaysia, and confirmed by the mother of this student, Mrs. Tan Siew Lan (294 Jalan Tan Sri Manickavasagam, 70200 Seremban, Negeri Sembilan, West Malaysia). Here is the summary of this legend:

"A fisherman named Yeang Xiang-Ji gave all his daily catch to calm a band of hooligans who threw stones onto a miraculous turtle the shell of which shone with five different colours: bright red, navy blue, cool green, sparkling yellow, and shiny brown. {It is interesting that the description of this turtle exactly corresponds to the appearance of a typical UFO.} As a sign of gratitude for his generous gesture a beautiful maiden come out from the turtle. She introduced herself as a daughter of the King of the Sea and invited him to visit the palace of her father. {In this Chinese legend, the King of the Sea closely resembles European tales about Neptune.} The fisherman dazzled by her beauty agreed of course. After entering the turtle they submerged into the sea water and some time later they arrived to a beautiful palace glowing with a strange light. {Again it is interesting that the palace of the King of the Sea, as well as travelling to it, in this legend very closely corresponds to a description of a visit to a submerged UFO.} The King of the Sea, after getting to know Yeang Xiang-Ji, proposed him to stay in his palace forever and marrying his beautiful daughter. Of course, the fisherman agreed. But the condition of the marriage and staying in the palace was that the fisherman would never open a magical box shaped like a crystal cube which was positioned in the centre of the palace. From

this box supposedly originated the whole magical power of the King of the Sea. {Again it is worth noticing that both the appearance and the positioning in the centre of the palace of this box correspond to these of the twin-chamber capsule from the main propulsor of Magnocraft and UFOs - see descriptions from subsection F2 of this monograph.} Of course, the irresponsible fisherman could not resist the temptation to open this magical box, thus bringing the enormous sea flood to Earth which killed vast number of people, including Yeang Xiang-Ji."

If the content of the legend of Mrs. Lee is translated into the present language, the great sea flood in China (and in other lands) was brought about by accidental and very unwise release of the magnetic energy contained in the Oscillatory Chamber of a UFO. For such an interpretation the cause for this flood would be the same as that described in [5]. In this way the above legend represents an additional mythological evidence confirming the presence of Oscillatory Chambers on decks of UFOs.

S5. Historical descriptions of the Oscillatory Chamber

Observations of vehicles presently known under the name of UFOs were carried out on Earth from the most ancient times. Actually if one closely analyses the data available on this matter, the more ancient the more direct and vigorous contacts between extraterrestrials and Earth's people seem to be. In the complete antiquity these extraterrestrials even tried to convey their technologies to Earth's people (e.g. by teaching them how to build Oscillatory Chambers...). Thus it should not be a surprise that the descriptions of the Oscillatory Chamber are contained not only in the modern literature but also in various historical books. The only reason why these descriptions do not attract our attention is that the older writings are the more ambiguous and confusing their terminology is. Thus in order for us to understand what they really represent, firstly it is necessary to "translate" them into the present language. In order to provide here an example of the description of the Oscillatory Chamber originating from such a historic source, it is contained in presently classical and well known work **[1S5]** by Jonathan Swift "Gulliver's Travels". In chapter III of this work, describing the trip to Laputa, an interior of the Laputans "flying island" was presented (i.e. a UFO). A device which caused the flight of this discoidal island was a magnetic stone (i.e. the Oscillatory Chamber) positioned in its centre, the slanting of which caused a change in the direction of flight.

In the imprecise terminology of our ancestors the word "stone" was, amongst others, used to describe an object which today would rather be defined with use of the term "crystal". Actually, a number of people abducted on UFOs refer to the Oscillatory Chamber as to "a crystal" (probably because of the transparency of this device and also because of the flat, shiny walls which form a regular shape resembling crystals of some minerals). In various old documents there are descriptions of another "stone" which, because of its unusual properties, in fact could be an Oscillatory Chamber producing the Telekinetic Effect. This is a famous "philosophers' stone", into the range of unusual properties of which included was, amongst others, the ability to convert sand into gold. It is interesting that from the empirical sources completely unconnected with this stone seem to appear that the Telekinetic Effect most probably is able to transform some elements into others; perhaps including in this silicone (contained in sand) and some other element (e.g. iron) transformed into gold and some other element (e.g. sulphur) - see subsection NB3. Areas where just such a transformation seemingly appeared at a very large scale was ancient Kolchida, Tapanui in New Zealand, and Tunguska in Siberia - see descriptions in monograph [5/4]. As "in every legend there is a grain of truth", perhaps also the idea of a philosophers' stone was born when some advanced extraterrestrial visitor demonstrated to crowds of amused Earth people the capability of his telekinetic Oscillatory Chamber. Of course, today's observers taking a part in a similar public show and listening to the accompanying explanations, to describe the object they saw would rather use the term "psychokinetic crystal" instead of the term "philosophers' stone". Similarly as a few centuries ago, also now the descriptions of these people confirmed by crowds of eye

witnesses, probably would immediately initiate amongst chemists the efforts to find ingredients that would allow to grow a crystal of such unusual properties. After all, similar demonstrations, only that showing the healing properties of telekinetic Oscillatory Chambers (which were described in subsection S1.4 and also near the end of subsection L2), quite frequently conducted for people abducted on decks of UFOs, have already caused on Earth the initiation of searches for the "healing utilization of vibrations of crystals". Already entire books were written about various crystals and their "healing vibrations", whereas in some countries special shops sell crystals for healing purposes. The only aspect which this newly born trend of neo-alchemism overlooks is that "crystals" causing almost instant healing effects must be precisely assembled by engineers in factories like present computers, not grown by chemists in test-tubes like beads for teenagers.

Numerous ancient sources also contain descriptions of a mysterious device which can be interpreted as an ancient version of the Oscillatory Chamber built on Earth. The most extensive sources concerning this device originate from Tibetan Buddhists - see **Figure S7**. In Christian tradition we know such a device by the name of the Ark of the Covenant.

As well as in the Bible, the Ark of the Covenant is also mentioned in the Jewish cabalistic work, the "Book of Zohar" (the Bible of Kabbalah), the Ethiopian epic, "Kebra Nagast", and in the Indian epics, "Mahabharata" and "Ramayana". Throughout history, a number of scientists have tried to reveal the secret of the Ark and to determine what kind of device it was. Various investigators came to different conclusions, on one occasion describing the Ark of the Covenant as "a fairly complete system of electrical instruments" (a German philosopher and mathematician, Lazarus Bendavid), and on another occasion as the "manna machine" (see the book **[2S5]** "The Manna Machine", by George Sassoon and Rodney Dale, London 1978). A review of the conclusions drawn by various investigators in this matter is contained in the book **[3S5]** Erich von Däniken, "Signs of the Gods?", Souvenir Press, London, 1980, ISBN 0-285-62435-0.

In 1984, when the first monograph [2C] on the Oscillatory Chamber was published, a number of readers drew my attention to the fact that the attributes of the Oscillatory Chamber very closely correspond to those of the Ark of the Covenant. I followed up all these suggestions and the results of my findings are presented in this subsection.

From the material accumulated so-far, of course it can not be conclusively proven that the Ark of the Covenant was in fact the ancient version of the Oscillatory Chamber. But it seems to be highly probable that the Ark was, in its entirety, an Oscillatory Chamber, or contained the chamber as one of its vital parts. The evidence that supports such a conclusion is as follows:

#1. The **simplicity** of the Ark corresponds to that of the Oscillatory Chamber. Moses was only provided with written instructions and with a display of a working model in operation, but the Ark itself was made by Jewish craftsmen entirely of materials accessible to them. Therefore it could not require skills, tools, or materials (e.g. radioactive isotopes) only available to societies having highly advanced technologies. The Oscillatory Chamber, in contrast to a nuclear reactor or fusion installation, is a simple device - sufficiently straight-forward to be completed without difficulties a few thousand years ago, if, of course, the instructions for its production were provided by someone holding the necessary knowledge.

#2. The shape, structure, and **materials** of the Ark are identical to those required by the Oscillatory Chamber. The Ark also took the form of a chamber, empty inside, and square in one of its cross-sections. The ratio of its dimensions (width : height : length) was 1 : 1 : 1.75. Similarly to the chamber, the chest of the Ark was made of an electric insulator (i.e. acacia wood) which incorporated some conductive elements (i.e. gold plates and nails). Both these materials were magnetically neutral.

#3. The Ark was without doubt the source of a very **strong field**, possessing an identical nature to a magnetic one. This field caused an illness quite similar in symptoms to exposure to strong radiation (e.g. note the fatal illness of the Philistines - see Samuel I 5:6). The Levites designated to carry the Ark wore special protective clothing as a screening from

this field, which later provided a prototype for uniforms of monks. The power emitted from the Ark is referred to as "the Ancient of Days" (the most comprehensive description of this power is provided in the book "Zohar").

Various deductions incorporated into the Concept of Dipolar Gravity reveal that there is a striking similarity between the present concept of "magnetic field" as revealed in subsection H5.2, and the old concept of "The Ancient of Days". This similarity extends to all interpretations that Christian tradition assigns to the Ancient of Days. It is analyzed in greater depth in monograph [3C]. Just as an example of these analyses, the commonly known physical properties of a magnetic field (') are confronted here with some old interpretation for the Ancient of Days (").

(') Some attributes of magnetic field include: invisibility, silent interactions, transmission of power, induction of glows, relation to light. Oscillatory Chambers will be the most powerful sources of a magnetic field (chapter C).

(") The Ancient of Days was interpreted as a name for the mysterious power emitted from the Ark of the Covenant. Examples of such interpretation are in the following hymns still in use in Presbyterian churches (see: Hymns 32 and 35, "The Psalms and Church Hymnary", Oxford University Press, London 1973):

32: "Immortal, invisible, God only wise
In light inaccessible hid from our eyes
Most blessed, most glorious, the Ancient of Days
... Unresting, unhasting, and silent as light
... Great Father of Glory, pure Father of light ..."
35: "O worship the King all glorious above;
... Our Shield and Defender, the Ancient of Days,
Pavilioned in splendour and girded with praise ...".

It is worth noticing that Hymn 32 explains attributes of the Ancient of Days, whereas Hymn 35 links the Ancient of Days with the Ark of the Covenant and implies that extraordinary powers of the Ark originated from properties of the Ancient of Days. (Note that the Ancient of Days is also mentioned in the Bible - see Daniel 7:9).

To comprehend more precisely the identical meaning of both concepts (i.e. a magnetic field, and the Ancient of Days), one should imagine how one would explain to the ancient Israelites what a magnetic field actually is. In this explanation only the terms and phenomena known and conceivable to them could be used. And then imagine also what would be left of this explanation after a few thousand years.

#4. The Ark induced **electric currents** in its external metallic parts and probably also in nearby conductive objects. People who touched its external gold parts were killed by an electric shock (e.g. Uzza's death - see Samuel II, 6:3-7). When transported from Israel to Ethiopia it destroyed a number of objects in Egypt, probably by inducing strong electric currents within them (compare the description from "Kebra Nagast" reproduced in [3S5] with the "inductive shield" formed by the field of the Magnocraft).

#5. The Ark produced strong external **forces** which acted on its transporters. In this matter the Ark was identical to the behaviour of the Oscillatory Chamber whose powerful magnetic field will also produce forces of interaction with the Earth's magnetic field capable of lifting people who try to carry this device. For carrying the small-sized Ark (or perhaps to prevent it from ascending) it was necessary to apply the strength of six Levities (not mentioning that the name of these people "Levities" was later assigned to the phenomenon of ascending into the air, i.e. "levitation"). The Ethiopian book, "Kebra Nagast", says that the Ark lifted people, loads and animals up into the air.

#6. The Ark produced strong forces acting on the **environment**. These forces can be explained as interaction between the Ark's magnetic field and nearby objects. An example of such forces could be the destruction of Jericho's fortifications. Also the famous formation of the channel within the Red Sea can be explained as an interaction between the strong, pulsating magnetic field produced by the Ark and particles of surrounding sea water. A quite similar

effect of repulsion of sea water is sometimes observed on UFOs submerging under the water.

#7. A vital component of the Ark could be stolen, when the Ark itself physically remained untouched. It is claimed in the epic, "Kebra Nagast", that the Ethiopian hero named "Bayna-lehkem" stole the Ark of the Covenant and delivered it to Ethiopia - see the description in [3S5], page 39. The epic explains in detail that in order to achieve this, he needed to prepare an exact copy of the Ark, according to the original descriptions obtained from Solomon. Then he put together both devices, collecting in this way the "power" of the original Ark. But this Ethiopian claim contradicts Jewish sources which although seem to confirm the theft, they simultaneously document that the Ark still remained operational in Israel after this event took place. The above (apparent) contradiction of claims could practically mean that not the physical structure of the Ark, but a part of the precious **magnetic energy** contained in the original Ark was in fact stolen by the Ethiopian hero, who used an exact copy of the Ark to carry it away. But the operational Ark itself, with the rest of its energy, still remained in Israel. Thus Israelites perhaps got upset because "Bayna-lehkem" stole the non-replaceable energy from the Ark, not the Ark itself.

#8. The name "Ark" could be interpreted as "a vehicle or a transporting device", not mentioning that the term "Ark of the Covenant" could mean the "**transporting device** given to initiate the cooperation and technological exchange". As such this name in the ancient language rather precisely expresses the functions of the Oscillatory Chamber described in this monograph.

Some readers at this point may wonder why I try to establish if the Ark was in fact an ancient version of the newly rediscovered Oscillatory Chamber. Justification lies in the chance of benefiting from old instructions for the building of this device. A detailed description of the Ark of the Covenant is contained in many ancient manuscripts, only a small fraction of which is listed at the beginning to this subsection. For example the cabalistic Book of Zohar devotes almost 50 pages to this purpose. Therefore, if in fact the Ark was an Oscillatory Chamber, then the documentation describing how to complete it with the simplest possible tools and materials is readily available - see Figure S7. Because the tools, materials, and knowledge accessible to every contemporary hobbyist, are without doubt superior to those available to ancient craftsmen, there should be no problems with the construction of this device. All we need to do is rigidly follow the old instructions.

The above assumption has already proved itself. Mr Ryszard Zudzin of Poland, who completed the first working model of the Oscillatory Chamber, based his device on the ancient descriptions of the Ark of the Covenant (a photograph of his working device is shown in Figure C13). One of the vital solutions which he acquired from these ancient descriptions were needle-shaped electrodes - see Figure C2. He got the idea of using these electrodes from the descriptions of gold nails driven into the Ark's wooden walls.

S6. A photograph of the octagonal oscillatory chamber from invisible UFO of the second generation

Previous parts of this chapter presented descriptions and photographs of the square in cross-section oscillatory chambers of the first generation. These are mounted in propulsors of magnetic UFO of the first generation. So at this point it would be beneficial to let the reader know also how photographs of more advanced **octagonal** oscillatory chambers of the second generation look like. After all, in my research to-date I already encountered photographs, which represent outlets from UFO propulsors that utilise octagonal oscillatory chambers of the second generation. It would be a good idea to show here and to interpret the best example of these photographs.

Previous parts of this monograph already presented descriptions and illustrations of the octagonal oscillatory chambers of the second generation. But in large proportion these descriptions and illustrations were theoretical ones. For example, they included explanations of

the design and operation of such oscillatory chambers. These were described in subsections C4.1, C7.1.1, and C7.2.2, while were illustrated in Figures C3, C8, and C11 of this monograph. In turn photographs of octagonal oscillatory chambers of the second generation that were taken on actual UFOs, were interpreted just only briefly. For example, such photographs are shown in Figures P19 D, and P29. In turn general descriptions of such octagonal oscillatory chambers from UFOs of the second generation are presented only in subsection T1.

I already encountered even much more exact illustrations of the appearance of these octagonal oscillatory chambers of the second generation, than the photos that I am able to reproduce here. These are shown on a film, which I am not able to present in this monograph. This is the American film "Fires in the Sky". It even illustrates the fall of the main hero onto the outlet from one such octagonal oscillatory chambers. It also illustrates the exact appearance of an entire main propulsor of a UFO that contains two such octagonal oscillatory chambers of the second generation.

In my research to-date I had opportunity to analyse a very meaningful photograph of the outlet from an octagonal oscillatory chamber of the second generation. This photograph is so representative to what we usually capture on our photographs, that I am going to show it and interpret exactly in this subsection. It was taken in the morning just after a night expedition to a mountain in Poland, called "Babia Gora". This mountain is described in more details in subsection O5.3.2. Inside of it UFO tunnels are hidden. The expedition took place during a night from 4 on 5 July 1999. It is described in details in subsection C5 from the Polish treatise [4B]. This expedition had 3 participants. During the course of it, several photographs were taken. Because of a surprising "coincidence", three out of these photographs managed to capture octagonal oscillatory chambers of two invisible UFOs of the second generation, which that particular night were watching on the Babia Gora participants of that expedition. So these photographs have a high significance. After all, they support my claim, that UFOonauts try to hold back our searches for glossy UFO tunnels from the Babia Gora. In this holding back UFOonauts even resort to sending two large UFO vehicles to watch members of a search party. These UFO vehicles did everything possible to disallow finding of the entrance to a UFO tunnel. In addition to the above, the photographs add also a lot to our knowledge of UFOs. After all, they reveal how an octagonal oscillatory chamber from invisible UFO of the second generation look like on photographs. Many people capture such octagonal chambers on film. But usually either ignore their significance later, or try to explain them "rationally" by bending facts for this purpose. For these reasons, in this subsection I am going to present a comprehensive interpretation of that most clear photograph of the octagonal oscillatory chamber from invisible UFO, taken during that expedition to the Polish Babia Gora.

This particularly clear picture of the octagonal oscillatory chamber from an invisible UFO was captured on film by Mr Leszek Staszl. He was one of participants of the discussed here search expedition to the Babia Gora. He is shown in the centre amongst these three people from the photo on Figure S8. The photograph was taken on 5 July 1999, around 7:30 in the morning. Mr Staszl used a photo camera Canon Eos 630 with a tripod. A black-white photocopy of this photograph is enclosed to this description as **Figure S8**. The attention should be directed at that snow-white, 5-sided geometrical figure in the top-right corner of the photo. In the part of Figure S8 marked (low-left) a map of that area is shown, which explains the circumstances of taking this photo. From this map it is visible, that the Sun marked "SL" was positioned beyond the angle (47 degrees) of visibility of the lens from photographing camera. Thus this snow-white object captured on this photo cannot be e.g. a reflection of the Sun in the lens of the camera.

In spite of a very humble shape that it shows, the photograph from Figure S8 is extremely important. It provides us with a visual evidence, that UFOonauts do not wish people search UFO tunnels that exist under the Babia Gora. (For more details about these tunnels see subsection O5.3.2.) As this stems from my research, UFOonauts constantly watch people about whom the know from the analysis of the future, that they found the entrance to these UFO tunnels. They also obstruct work of these people, as only they can. (In a similar manner

UFO-nauts obstruct also efforts of all other people whose activity runs against their occupational interests on Earth.) Fortunately for us, probably in order to even the chances, the universal intellect gave us the evidence of this continuous interference of UFOs. The evidence is the photo discussed here. The only thing that is left now, is to understand and to accept the complex information that this photograph contains.

On the photograph discussed here, similarly like on other two photographs of UFO oscillatory chambers taken during that expedition, the outlines of four edges of the outlet from an oscillatory chamber are captured. This means that captured is only around 40% of the surface area of this octagonal chamber. This outlet, glowing with the snow-white "extraction glow", originates from the inner chamber of the main propulsor of an invisible UFO vehicle of the second generation.

Let us now explain what actually is this snow-white polygon from the photo in Figure S8, and why it has just such a shape, and not any other one. For a better understanding what this photograph shows, in my explanations I refer to additional illustrations. For easier viewing, these additional illustrations are attached to the photograph from Figure S8. But their descriptions originally are provided in other parts of this monograph.

In order to understand exactly what is captured on the photograph discussed here, we also need to know several facts that are presented in other parts of this monograph. Let us start from reminding ourselves these facts briefly:

#I. Oscillatory Chambers of the second generation emit the snow-white "extraction glow". Firstly I should remind here what is this snow-white "extraction glow". After all, the outlet from the UFO oscillatory chamber captured on this photo, gives out this white "extraction glow". An exact explanation as to what this glow is, is provided in subsection H6.1.3 of this monograph. Generally speaking, "extraction glow" is a type of light which is produced by all objects that complete any telekinetic work. Therefore it is also given out by e.g. octagonal oscillatory chambers that propel UFOs of the second generation that just operate in the mode of telekinetic flickering. (Notice that according to descriptions from subsection L2, this telekinetic flickering guarantees to UFOs a visual invisibility to human eyes.) The extraction glow always has the snow-white colour, means the colour that was captured on photograph from Figure S8.

#II. The intensity of the extraction glow is pulsating. As this is explained in other chapters of this monograph, the magnetic field of UFOs is pulsating. Thus also the intensity of the extraction glow must change in a wavy manner. So depending on our luck, at the moment of pressing the button in our camera, this extraction glow may be either very intense, or almost invisible. If it is extremely intense, then on the photograph it reveals snow-white outlines of UFO oscillatory chambers, like outlines captured on the photo from Figure S8. But if the glow is almost invisible, then the photo shows outlines, which look like a shadow or a cloud of fog hardly visible to human eyes. So it takes a lot of luck, to accidentally manage to capture on a photo, an extraction glow with the intensity equally powerful like that one from Figure S8. A huge majority of UFO photographs that I analysed, have this extraction glow hardly visible, thus producing outlines of oscillatory chambers looking almost like made of mist of weak shadows.

#III. Octagonal shapes of the oscillatory chambers of the second generation. Another matter that requires reminding to understand the object photographed in Figure S8, is that oscillatory chambers from propulsors of telekinetic UFOs have the shape of octagonal rods. Thus UFOs of the second generation, which are capable of becoming invisible due to "telekinetic flickering", have octagonal outlets in all their propulsors. The shape of these propulsors can be seen in the part marked (low left) from Figure S8. Additionally the same shape can be seen in part (2s) from Figure C8 of this monograph.

#IV. Every UFO propulsor contains two oscillatory chambers. As this is explained in subsection C7.1, in order to control the power and output of UFO propulsors, oscillatory chambers of discoidal UFO vehicles always work in couples. Two such chambers always are combined together, forming the so-called "twin chamber capsules". In these capsules always

to the outside is yielded only a small part of their total magnetic output. The remaining part of this output is circulated inside of a given capsule.

#V. Mode of the inner flux prevalence. Another matter which we need to know in order to understand the photograph discussed here, is that the twin-chamber capsules from the propulsors of UFOs may operate in two different modes. One of these modes can be called the "inner flux prevalence". It depends on the inner oscillatory chamber from a given twin-chamber capsule sending its output to the outside of a UFO vehicle. In turn another of these two modes can be called the "outer flux prevalence". It depends on the outer oscillatory chamber from a given twin-chamber capsule sending the output to the outside of a UFO vehicle. The appearance of the outlets from a twin-chamber capsule of the second generation during these two modes of operation is shown in the part of Figure S8 marked as (top left). In turn the mode with the "inner flux prevalence" is visible over there at the upper one of both outlets shown there. Notice that in this mode only the outlet from the inner oscillatory chamber glows snow-white. In the remaining mode of the "outer flux prevalence", illustrated with the lower outlet at that (top left) section of the Figure, always snow-white glows the outlet from the outer oscillatory chamber. In order to understand better what this mode of the inner flux prevalence is all about, it is also worth to have a look at Figures C5, C6 and C7 of this monograph, and also to read appropriate descriptions from subsection C7.1. In case of the operation in the mode of inner flux prevalence, if someone looks straight at the outlet from such a twin-chamber capsule working in a visible state, then he should see this outlet as a regular octagon. This outlet would also emit a snow-white extraction glow. Notice that in order to become visible, such a capsule would need to be observed before it enters the state of telekinetic flickering.) Such an octagonal outlet is shown in the upper outline from the part marked (top left) of Figure S8. It originally is shown and explained in part (2i) of Figure C8.

#VI. Bending of the light that follows force lines of a powerful magnetic field, causes the disappearance of the UFO hulk and appearance of outlets only from the main propulsor of this vehicle. In addition to all the above, we need to also remind ourselves, that when magnetic fields are so powerful as these produced by UFO vehicles, then the light moves exclusively along force lines of such magnetic fields. These force lines of a powerful magnetic field perform for the light the function of a collection of parallel fibre-optic cables. The phenomenon of this motion of the light exclusively along field force lines is explained in part marked (low centre) of Figure S8. Originally it was presented in Figure F32. The result of this phenomenon is, that the hulk of the entire UFO is like hermetically wrapped into force lines of a powerful magnetic field. Therefore this hulk becomes completely invisible to an outside observer. An outside observer is only able to see the outlet from the main propulsor of a given UFO vehicle. This phenomenon of hiding of the hulk of UFOs by the magnetic field, and revealing only the outlet from the main propulsor, in this monograph is described under the name of "magnetic lens". The description of this lens is contained in subsection F10.4.1.

#VII. Bending of the light along force lines of a powerful magnetic field, frequently hides from the view a half of the oscillatory chamber. Because of this tendency of the light to follow exclusively along force lines of a powerful magnetic field, the observer which looks at the outlet of a UFO propulsor from a point slightly to a side in relationship to the magnetic axis of a UFO vehicle, is not going to see the entire outlet from this propulsor. This means that such an observer is NOT going to see the extraction glow coming out from the entire surface of the outlet of that particular propulsor. He is going to see only this part of the surface of the outlet, from which originate the force lines that come towards his eyes. Putting this in another words, when viewing a UFO propulsor of the second generation from a point different than straight from below the magnetic axis of this propulsor, instead of a snow-white octagon, such an observer is going to see only around 40% of the surface of this octagon. In addition, this small fragment will be deformed because of the bend paths of force lines of magnetic field that carry the picture of this fragment. Means that such an observer is to see exactly the shape that was captured on the photograph from Figure S8. So looking at this photograph from Figure S8 we need to take a correction for the fact, that the shape captured there was deformed in such a

manner.

The photograph from Figure S8 captures two complete side edges, and two further halves of such edges, from the octagonal outlet of a UFO oscillatory chamber. But the curved paths of the force lines of UFO magnetic field, and also viewing this octagon under a large angle, caused that normally regular outline of side edges of the octagon from outlet of the propulsor, was deformed. For a better understanding of this deformation of a section of octagon discussed here, one would need to view such an octagon when it is deflected in a concave mirror. In order to see other examples of the same effect of appearing of only around a half of the outlet from a UFO propulsor, one should also see Figure S5. That Figure S5 shows also around a half of the outlet from a UFO propulsor, only that this one is a cubical propulsor from a UFO of the first generation, instead of the octagonal propulsor from a UFO of the second generation. For a comparison, it is also worth to have a look at Figure C6, which explains what that Figure S8 would show, if someone looks at it exactly along the magnetic axis of the propulsor, instead of looking under a large angle. Summarising the above, on the photograph from Figure S8 discussed here, almost a half of the slightly distorted outlet from the octagonal oscillatory chamber in the main propulsor of a UFO of the second generation was captured.

There is also an independent and very meaningful evidence, which additionally confirms, that the photograph shown in Figure S8 really captured the outlet from an oscillatory chamber of an invisible UFO. This evidence is the fact, that the photo camera Canon Eos 630 of Mr Leszek Staszl, with which this photo was taken, was "telekinetised" by the field of that UFO. As it turned out later, after that particular night the electronics of that camera "went crazy". In turn such "going crazy" is one of typical manifestations of telekinetisation described in subsection U3.6. (Another typical sign of telekinetisation is, that this electronics is then going to repair all by itself, after around a week or two. Of course, this self-repairment occurs only if during the action of the telekinetic field of a UFO, no electronic circuit is burned up. The self-repairment results from the gradual diminishing of the telekinetic field that is a reason for this "getting crazy" of devices.) This photo camera started to show clear signs of spoiling. One time it kept jamming, in other times it showed various strange information on the panel, etc. In the result, Mr Leszek Staszl decided to get rid of it. Soon afterwards he bought a fully professional Minolta 9Xi.

The above should be complemented with the information regarding the size, and thus the significance, of the outlet that is captured on Figure S8. In Table F1 of this monograph a column marked " a_M " is presented. It expresses the linear dimension of a cubical external oscillatory chamber of the first generation from the main propulsor of Magnocraft and UFOs of a given type. In parts (top left) and (low left) of Figure S8 this dimension is represented by the symbol "D". Knowing this dimension " a_M ", we can calculate also the linear dimension of " a_{MI} " of the inner oscillatory chamber from the main propulsor of UFOs of given types. In parts (top left) and (low left) of Figure S8, this dimension is represented by the symbol "d". It is expressed by the equation (C9) " $a_{MI}=a_M/\text{sqrt}(3)$ ", where the symbol "sqrt(3)" is borrowed from the computer programming notation and means a square root from the number 3. If we carry out appropriate calculations, then it turns out, that for a UFO type K3 the linear dimension of the inner oscillatory chamber from the main propulsor is equal to $a_{MI}=0.28$ meter, for a UFO type K4 this dimension is equal to $a_{MI}=0.43$ meter, for a UFO type K5 it is equal to $a_{MI}=0.62$, for a UFO type K6 it is equal to $a_{MI}=1.14$ meter, while for a UFO type K7 it is equal to $a_{MI}=1.96$ meter. Judging both, the distance and the relative size of this white outlet from the oscillatory chamber captured on Figure S8 in relationship to sizes of people, it appears that out of all dimensions listed above, the closest one is the dimension $a_{MI}=1.14$ meter. This in turn means, that this particular searching expedition to the Babia Gora was watched by a huge UFO vehicle of K6 type. It has 6 crew members on the board as a standard. (In special circumstances this number can be additionally increased.) Its external diameter is equal to $D=35.11$ meters. It is also overloaded with various precise and highly refined equipment for listening, manipulation on human minds, etc. This in turn meaningfully indicates, how much significance UFO-nauts

pay to the obstructing of our searches for UFO tunnels on the Babia Gora. After all, for watching and misleading this searching expedition, UFOonauts assigned two very large UFO vehicles, each one of which contained at least 6 cosmic policemen and saboteurs. This looks approximately as if during the World War Two Germans send 2 large cruisers to watch a small fishing boat. (If such thing would really happen, then everyone would know, that whatever this fishing boat does, Germans consider it to be extremely dangerous for their interests.)

The photograph of the outlet from a UFO propulsor, glowing with a snow-white extraction glow illustrated and discussed in this subsection, is very important. This is because many people actually photograph such oscillatory chambers from invisible UFOs, only that they do not know what these chambers mean. So when these people find such strange geometrical figures on their photographs, then they try to invent some sort of rational explanation for their existence. For example, most frequently people explain these figures as internal images of the shutter from the camera, reflected from the lens of this camera. Of course, during forming such a "rational" explanations, people bend many facts and break many laws of physics. For example the explanation that these shapes are just reflections of the shutter in the lens, is contradictory to real facts in following points:

(a) Wrong colour. Reflections of the shutter in the lens of camera would not produce a white extraction glow. But just such a glow is produced by oscillatory chambers from UFO propulsors. This extraction glow makes the outlets from UFO oscillatory chambers looking snow-white - if they are photographed during a daylight, or clearly glowing with a pure white light - if they are taken during a night. (The temperature of colour of such chalk white light exceeds 5600 Kelvins.)

(b) The lack of symmetry. Reflections from shutter or aperture would not take asymmetrical shapes, which are characteristic for fragments of outlets from UFO oscillatory chambers deformed by the action of curvilinear paths of UFO magnetic field. For example, outlets from oscillatory chambers of UFOs of the second generation are usually captured as fragments of deformed octagons. In turn outlets from oscillatory chambers of the third generation are usually captured as fragments of deformed sixteen-sided polygon. Thus, on photographs taken under a large angle, these may come out as either asymmetrical 5-sided or 9-sided figures. In turn the majority of shutters in present photo-cameras have the shape of a gap with exactly rectangular outline. On the other hand, all irises in cameras have exactly symmetrical shapes, and have no rights to come up on photos as e.g. asymmetrical 5-sided polygon.

(c) Similarity to UFO chambers. Reflections of the shutter should not take resultant shapes that coincide exactly to the shapes of outlets from propulsors of UFOs. Surely they should not look like such capsules working in the mode of inner flux prevalence, or as working in the mode of outer flux prevalence. Especially that in cases of capturing an outlet from a twin-chamber capsule that operates in a mode of the outer flux prevalence, quite an unique shape is recorded. This shape is composed from a section of two octagons placed one inside of another one. Furthermore, this shape shows proportions of dimensions that are close to these described by the equation (C9): $a_{MO}=a_{MI}\sqrt{3}$. Just such a shape I captured accidentally above the Tapanui crater - as described in the further part of this subsection.

(d) Too many sizes. Oscillatory chambers of UFOs are photographed in many different sizes. After all, captured on photos can be chambers of various types of UFOs, that mutually differ in sizes. But in case of the use of cameras with a constant focus length of the lens, the reflections of the shutter must not take on photographs many different sizes. (Note that such "no-zoom" cameras not long ago represented the majority of popularly used photographic equipment.) After all, in such cameras the shutter is always in the same distance from the plane of reflection in the lens. Thus the reflection of this shutter should always have the same size in relation to the frame of negative. (Unfortunately, in some modern cameras with zoom lenses, the above loses its validity. In such cameras the internal reflections of shutters not always would need to have the same size. This of course would only appear in cases, when during photographing the lens of the camera would be intentionally altered from the value that

is set for it automatically.) In turn even only during the expedition to the Babia Gora discussed here, several oscillatory chambers of UFOs were captured on photos, out of which almost each one is a different size from the remaining ones. Only reflections from the iris, because of the ability to open and close, could take various sizes on photos. However, such reflections always would be symmetrical and coinciding with their geometrical shape.

(e) Unexplained phenomena. If captured are just inner reflections in a camera, these reflections should not be accompanied by strange phenomena. Such strange phenomena can be only induced by UFOs. Examples of such strange phenomena, that were registered during taking the photograph from Figure S8, were (1) "getting crazy" of electronics from the camera of Mr Leszek Staszl, that occurred after taking the photograph from Figure S8, and (2) quiet buzzing like an electrical transformer, that was heard during the night after which the photo from Figure S8 was taken.

The type of photographs of the UFO oscillatory chamber described here, is one of the most frequently appearing shapes of UFOs accidentally captured on photographs. Therefore it is worth to get to know exactly everything that is connected with this photograph. After all, if at some stage we ourselves find such oscillatory chambers on our own photographs, or on photographs of someone from our close ones, than we will know what exactly they mean. Therefore we will not ignore their significance. At this stage I must admit, that many years ago before I accumulated the knowledge necessary for understanding the significance of these photographs, I already saw such an oscillatory chamber on several photographs taken by other people. On several occasions I even took myself photographs of such a chamber. Unfortunately, after I found and analysed several my own photographs, which captured similar oscillatory chambers of invisible UFOs, I realised that these my photographs are not so spectacular as the one shown in Figure S8. Therefore my photos are not suitable to be published in a black-white copies. (But on someone's wish I may make them available to people who are going to subject them to a detailed research.) I also remember cases of such photographs, which now I am unable to find in my files dispersed over several different countries. Most vividly in my memory is etched one of them. It was when in 1988 I photographed such a chamber for the last time. I photographed then the Tapanui Crater. By an accident I passed the lens of my camera through the sky, directing it towards the Sun. I managed to record then, hiding from me exactly under the Sun, a perfectly visible twin-chamber capsule of the second generation. It worked in the mode of the outer flux prevalence. Most probably it belonged to a UFO of the second generation that observed my activities over there. This UFO saw that I work with the camera, so it positioned itself exactly under the Sun, giving me no chance to film it by accident.

On the basis of my analyses to-date of appearances of twin-chamber capsules of invisible UFOs, that I managed to capture on photographs and then research, already now it is possible to disclose the most important attributes of these capsules. These attributes should provide the reader with the ability to recognise oscillatory chambers of invisible UFOs, if he ever managed to capture them on his own photographs. Here they are:

#1. Circumstances of accidental photographing of UFOs. The outlets of twin-chamber capsules of invisible UFOs are captured on photographs mainly if: (1) a given photograph is taken either in the direction towards the Sun, or (2) the optical axis of the photo-camera is directed approximately parallel to the local course of magnetic force lines. The reason why UFOs are frequently photographed directly towards the Sun, is that if UFO-nauts realise, that someone takes photographs, then they hide their UFO vehicle through positioning it directly under the Sun. In turn positioning the camera according to the local course of force lines of magnetic field, requires that the camera is directed towards magnetic north or south. The deviation of the optical axis of the camera from the course of local force lines should not exceed 30 degrees. The best results are obtained when both above conditions are fulfilled simultaneously. This requires photographing near the noon with the camera pointed towards south. Of course, the condition of success in capturing an outlet from a propulsor of an invisible UFO, is that this UFO is present near the camera, or possibly on the line of the lens. This in

turn usually takes place when in front of the camera is someone, who in a given times carries out activities that run against interests of UFOonauts. This is because such someone is watched by UFOonauts. An example of such people can be a person who researches UFO landing sites, who photographs UFO explosion sites, who searches for UFO tunnels, who just builds or tests revealing devices or UFO detectors, etc.

#2. Colours of the outlets from UFO propulsors. On the daytime photographs, the outlets from twin-chamber capsules in main propulsors of invisible UFOs, always come out white. However, the intensity of this whiteness depends on the luck, or more strictly on the moment in the cycle of pulsations of the field of a given UFO, in which the button of camera was pressed. In turn this white colour allows to notice UFO chambers quite easily. Especially on colour photographs. During nights, chamber outlets always emit white extraction glow, the intensity of which also pulsates.

#3. Shapes of outlets from oscillatory chambers. Outlets from twin-chamber capsules of invisible UFOs in the majority of cases come out on photographs as polygons. Their shape resembles the deformed in a concave mirror outline of a fragment of the regular octagon - if the UFO is second generation. In case of UFOs of the third generation - fragments of a regular polygon with sixteen-sides that was deformed in a concave mirror. But because the majority of photographs take UFOs which belong to the second generation, the captured fragment of their octagonal outlet usually has the shape of an irregular 5-sided polygon, as the one shown in Figure S8. In this way the geometrical shape of a 5-sided polygon with 5 sharp corners, is going to clearly differ from fluent shapes that would be formed by various imperfections on film or stains from processing chemicals. Of course, also in cases when someone captures on a photo the shape that approximately looks like a circle or ellipsis, then before deciding that this is just a stain, he firstly should check whether by any chance it is not a deformed fragment of a sixteen-sided oscillatory chamber that is used by UFOs of the third generation. After all, with such a large number of sides, their deformed capturing may look almost like a fragment of ellipsis or a circle.

#4. Differences in appearances of capsules in both modes of their operation. Outlets from the twin-chamber capsules of invisible UFOs that work in the outer flux prevalence, on photographs look as if in their centre some sort of angular break or angular black spot is located. Because of the curvature of magnetic field force lines along which the picture of this capsule is passed, the outline of this spot or angular break can be slightly deformed and slightly smaller than this results from equations. In turn outlets of capsules that operate with the inner flux prevalence have their centre filled up with uniform whiteness. This whiteness is equally uniform as the remaining parts of the outlines. As an example of such a capsule see Figure S8.

#5. Hovering of UFOs in mid-air. The outlets of twin-chamber capsules of invisible UFOs almost always are captured in such a manner, that they clearly look as hovering in mid-air. Their hovering should be easy to distinguish from various white objects that accidentally could be present on the line of photographing.

#6. Types and sizes of UFOs. All photographs of twin-chamber capsules from invisible UFOs that I researched so-far, were showing these UFO vehicles in a constant and always the same distance of around 30 meters from the person that UFOonauts just observed. So most probably UFO vehicles have a permanent program in their control computers, that always positions them in this constant distance of around 30 meters, and that continually guarantees that a UFO vehicle is located between the observed person and the Sun. In turn this constant distance between an invisible UFO vehicle and a given person, allows that from the greatest linear dimension of a capsule measured at a given photograph, the type of a UFO vehicle could be determined. After all, at a constant distance from the camera, the linear dimensions of outlets from twin-chamber capsules of invisible UFOs that show on photos, are only dependable on the type of vehicle, on the mode of operation of a given twin-chamber capsule - means on whether this capsule operates with the inner or with outer flux prevalence, and several parameters of photographing, such as the angle of lens in the photographing camera,

the size of film, or the enlargement of a given photograph. So if someone takes a photo with all photographing parameters kept to typical standards, then this linear dimension of the capsule depends exclusively on the type of a UFO vehicle. Such standard parameters mean, that the person uses a typical camera with the angle of lens equal to 47 degrees, that he/she captures this photograph on a standard film with 24x36 mm frames, and that this photo is then enlarged to a standard postcard size of 10x15 cm. In such a case, the twin-chamber capsule operating in the outer flux prevalence from a main propulsor of an invisible UFO types K3 to K10, on the prints of these photos will have the following maximal dimensions: from 1.7 to 2.1 mm for UFOs type K3, from 3.4 to 4.3 mm for UFOs type K4, from 7 to 8.6 mm for UFOs type K5, from 13.8 to 17.3 for UFOs type K6, from 27.7 to 34.6 mm for UFOs type K7, from 55.4 to 69.2 for UFOs type K9, and from 221.7 to 277.1 millimetres for UFOs type K10. In turn the capsule working in the inner flux prevalence captured in the same conditions, for UFOs types K3 to K10 would have the following maximal linear dimension: from 1 to 1.25 mm for UFOs type K3, from 2 to 2.5 mm for UFOs type K4, from 4 to 5 mm for UFOs type K5, from 8 to 10 mm for UFOs type K6, from 16 to 20 mm for UFOs type K7, from 32 to 40 mm for UFOs type K8, from 64 to 80 mm for UFOs type K9, and from 128 to 160 millimetres for UFOs type K10. The above data mean, that the chamber shown in Figure S8, that works in the inner flux prevalence, and which the highest linear dimension on a print of 10x15 cm is around 8 mm, according to this data belongs to a UFO type K6. These dimensions realise also, that if someone is observed by a UFO that is larger than K8, then the glowing outlines of propulsor from this UFO are not going to fit any more into the size of a print. Thus the entire photo looks then as if "tarnished with light". Actually I know several people, the activities of which are running against interests of UFOs, and the photographs of which quite regularly show the presence of streaks of light that cross the entire surface of their photographs. Previously such photographs were considered to be just effects of accidental exposing of film to a leaking light. But this subsection reveals, that these can also be oscillatory chambers of invisible UFOs of very large sizes (i.e. K8 or above). So such photographs can also be an evidence of someone's prosecution by UFOs!

Of course, if any parameter from the above list is changed, then also with the use of just an ordinary proportions it is possible to calculate a new set of dimensions for UFO capsules. For example, when instead of a print with dimensions of 10x15 cm, someone makes a print 6x9 cm, then the dimensions of capsules are going to change by the value of $6/10 = 9/15 = 0.6$. Thus for e.g. type K6 UFOs operating in the mode of inner flux prevalence, these new dimensions of capsules will be between 4.8 and 6 millimetres.

The above should be complemented with the information, that such accidentally photographed UFO vehicles not necessarily must watch a person that just is making a given photo. They also may follow someone who is in the background of a given photo. In such a case the largest linear dimensions of the capsules captured on a given photo will be different from these provided above - in most cases probably smaller. After all, the distance of the UFO vehicle from the lens of photo-camera is going to be different than these 30 meters.

#7. Intensity of glow of the outlets from UFO capsules. If photographs are taken with short times of exposure, then oscillatory chambers may be captured in various stages of their pulsating operation. Thus the intensity of whiteness of such capsules may differ significantly, depending on the stage of pulsation of the output from these chambers, which a given photo captured. After all, the intensity of emission of the extraction glow by outlet from a UFO propulsor depends on the magnetic output of this propulsor, means that for the pulsating field it keeps changing with time. Thus in extreme cases, on some photographs the twin-chamber capsules may be captured as almost invisible. Then these capsules will look like formed from a very weak white fog, through which the objects located behind them are clearly visible. On other photos outlets of the same capsules can be intensely-white, and looking as if they are solid objects cut out from white chalk. Of course, on various photographs also all intermediate states between these two extremes can be captured.

#8. UFOs are not fixed - they may fly away, or just arrive. So if several photographs of the same person, or the same view, are taken with short time gaps between each other,

then the outlets from invisible UFOs may be visible on one, or on some out of these photos, while no outlets may be present on the remaining photographs.

As this is stemming from research presented in chapters P, U, and V of this monograph, the presence of UFOs on Earth is very massive. If these vehicles do not hide from our sight by entering the state of telekinetic flickering that makes them invisible for our eyes, then we would see these vehicles almost everywhere. There would be almost as many of them as there was Germans in occupied countries during the World War Two. Means that several their UFO vehicles would be visible at the same time as they hover in our airspace, while their patrols would be visible in every larger building and on every larger crossing of streets. So when, after the analysis of photographs from Figure S8, we finally have an explanation as to what these types of photographs show, it automatically inspires a question. This question reads: "how UFOonauts do this, that in situation when a sensitive film is able to capture glowing outlets from their oscillatory chambers, and when there is so many UFOs around, still accidental photographing of UFO propulsors is relatively rare". The reply to this question was provided during my accidental capturing of a UFO oscillatory chamber in the Tapanui Crater that I described before and that I remember well. This is because it realised to me that if UFOs intend to come close to someone during a sunny day and observe this person, then they approach this person from the direction of the Sun. This manoeuvre is so typical for UFOonauts, that most probably computers that control their vehicles have a build-in permanent program of such approaching. Their computers implement this program in practically every case of approaching someone. This particular finding, that in order to avoid accidental photographing or noticing, UFOonauts always seem to place their vehicle in the direction towards the Sun from a person being watched, is quite a significant discovery which introduces many practical consequences. For example it reveals that **if someone is currently observed by a UFO vehicle, then in typical cases this vehicle is to be located in the direction of Sun from the person.** After all, such a placement of their UFO vehicle safeguards them against a situation, when such a person rapidly decides to take a photo. UFOonauts know jolly well, that almost no-one takes photographs against the Sun, and even if someone takes such a photo, then the photo usually does not come out at all.

After discovering the above principle used by UFOonauts to prevent their accidental photographing, I started to seek, whether apart from my own case of photographing and filming in the Tapanui Crater, there are also other cases that would confirm the same. To my surprise, I recalled further cases of the same type. For example, almost an identical observation was made by Mr Andrzej Domala of Poland, the coauthor of treatise [3B]. When a UFO was approaching him, the vehicle also make this manoeuvre coming exactly from the direction of the Sun. (The observation of Mr Domala is described in the Polish treatise [3B].) In addition to this, sometimes ago I saw an American film, that was described as based on real events. It shows a small town that was intrusively persecuted by a UFO vehicle. Inhabitants of this town forced this UFO vehicle to land, by coming out to the streets and flashing back rays of the Sun back towards the Sun with numerous mirrors. (It appears that the UFO was unable to refrain from checking what happens, and it landed on the main street of that town to check this town at a close range and to find out what inhabitants of it intend to do.)

Of course, knowing about this method used by UFO vehicles to hide from us, now we are able to appropriately utilise it. For example, if one wants to capture an invisible UFO on a film, and we know that it observes us, than the highest chance we have if with some method we manage to take a photo towards the Sun. Unfortunately, this is a difficult task, as ordinary films are too sensitive. However, there are low sensitive films available as well, and there are special techniques of photographing "against the Sun" - e.g. a method of taking a photo from a shadow. In turn if someone would have a fantasy to tease UFOonauts, then during a powerful sun he/she could put on the head some sort of a hat with numerous small mirrors! Such a hat would turn this person into a kind of flashing mirror-ball used in present discothèques. Such a mirror-ball would blind and irritate UFOonauts that observe this person. (But there is no hope, that UFOonauts would land their vehicle to have a better look at such a person.)

As this is explained more extensively in subsection VB4.1.3. of this monograph, whenever there is a chance that people find any evidence of the occupation of Earth by UFO-nauts, immediately UFO-nauts destroy the evidential value of this finding. Sometimes UFO-nauts carry out this destruction a significant time in advance, means long before given evidence is discovered. After all, from their knowledge of the future, UFO-nauts perfectly know in advance, that a given evidence is going to appear - for details see subsection V5. A good example of such destruction of evidence, which in an evil and cunning manner neutralised the evidential values of English "crop circles" described in subsection O5.1 of this monograph, was the "painting of pictures in crops" carried out on a large scale in England since 1999. Various "researchers" call already these "pictures" by a misleading name "pictograms". A part of these complex pictures was shown in the article "UK Crop Circles of 1999", which appeared on pages 49 to 54 of Australian bimonthly Nexus, Vol. 6, No. 6, October-November 1999. In the result of this painting, people who saw these very detailed and complex compositions in crops of England, started to doubt whether they really can be formed by UFO landings. Their minds could not accept that something as prosaic as a UFO landing in crops, is able to form so elaborate and so precise pictures. After all, these people do not understand that UFO propulsors are controlled by computers. Thus, on the command from crews, these propulsors are able to "paint" in crops precisely and effortlessly any complex picture, that the crew of this UFO is ordering them. They do it similarly as computer controlled embroidery machines are able to embroider any possible pattern that their programmers invent. Exactly the same method is used currently by UFO-nauts in their attempts to destroy the evidential value of photographs of outlets from UFO propulsors described in this subsection. Almost simultaneously with the dissemination of this subsection and subsection D2 in treatise [4B] - which contains a similar information, UFO-nauts started to "paint" with their oscillatory chambers quite complex "pictures of light". These pictures rapidly started to appear on a significant number of photographs of people. They are created when appropriately manoeuvred UFO vehicle paints a pattern at the moment of taking a photo. Some of these structures are so complex, that for various people it seems to be impossible that they are formed by something so prosaic as oscillatory chambers of invisible UFOs. This is exactly the same situation as that one when people could not accept that crop circles in England were "painted" by UFO propulsors. Several examples of such complex "pictures made of light" that were left by invisible UFOs on photographs taken "accidentally", were send to me by Mr Tomasz S. Gregorczyk (ul. Wloska 15/12, 30-638 Krakow, Poland). Some of "pictures of light" painted on these photographs are similarly complex as these "pictograms" from crops of England. Of course, in order to increase their destructive impact, UFO-nauts tried to also disseminate various theories about "cosmic energies" manifested on these photos. These theories claim, that such spectacular pictures made of light are simply manifestations of cosmic energies that have nothing to do with UFOs. In this manner UFO-nauts again try to repeat an old trick that turned out to be so effective in case of "pictograms" painted in crops of England. Of course, the question that we should ask ourselves is whether they again manage to lead us on. Are UFO-nauts going to succeed again with neutralising the correct line of explanation for these patterns of light captured on our photographs. There is about time we draw conclusions from ways these evil UFO-nauts always trick us in practically every matter. Let us not allow them to also laugh in this vital matter. Let us finally believe in statements of religions which for thousands of years warn us that we are continually being tricked and beguiled.

S7. To conclude this chapter

The vast body of evidence presented in this chapter consistently confirms the truth of the thesis proposed in the introduction, stating that: the Oscillatory Chamber is already utilized in UFOs as their propulsor and energy storage. Thus starting from this point the thesis of this chapter should be recognized as formally proven.

The proof that UFOs already use the Oscillatory Chamber introduces numerous implications. The first and the most important of these implications is the confirmation that the idea of the Oscillatory Chamber is valid and feasible. Such confirmation represents almost an equivalent to the presentation of a working model of the Oscillatory Chamber. Thus the mentioned proof should be vital encouragement to become involved in the building of this device as soon as possible. Of course, when the Oscillatory Chamber is built, the path for the completion of the Magnocraft is cleared. The other important implication is that the investigations of UFO Oscillatory Chambers facilitate the rapid and less expensive completion of these devices on Earth, through direct implementations of ready-made technical solutions observed from UFOs.

As a final reflection it is worth stressing that before I invented the Oscillatory Chamber, all the reports from UFO observations, which described a transparent cube witnessed on decks of these space vehicles, remained unnoticed. It seems that people are able to recognize only the objects whose meaning is previously known to them. Now everyone has the opportunity to learn the hidden significance of the plain transparent cube with lightning inside. Thus, it becomes our common responsibility to glean every new fact that may contribute to the completion of this device on Earth.

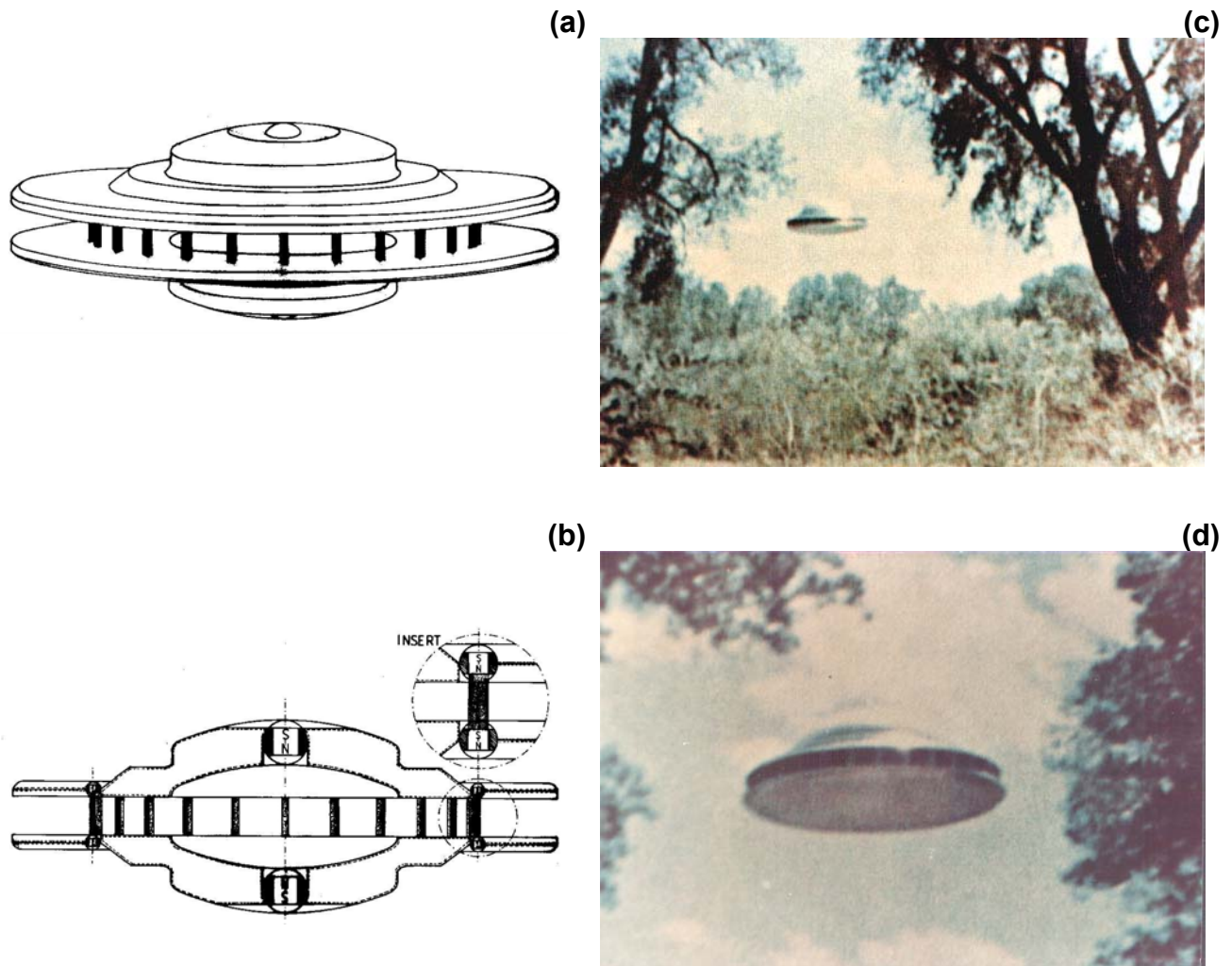
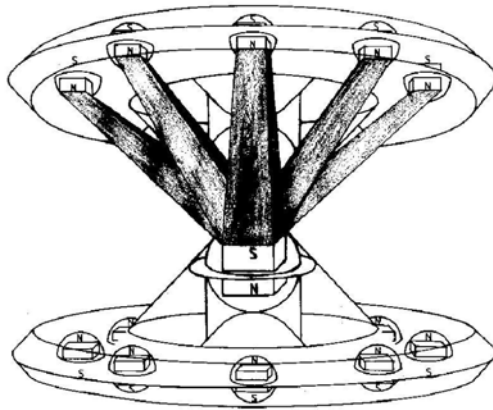

Fig. S1. Detached configuration of two UFOs, showing the so-called "black bars". The cross-section of these bars should reflect the shape of devices (Oscillatory Chambers) used in a given vehicle for producing magnetic field.

(a) The envisaged side view of two Magnocraft type K7 joined together into a detached configuration (see also part #3 in Figure F6). Around 11 black bars linking subsequent outlets from $n=24$ side propulsors in both vehicles are visible.

(b) The vertical cross-section through the Magnocraft type K7 shown in part (a). The INSERT illustrates the mutual orientation of magnetic poles (N, S) in two side propulsors facing each other assembled in both vehicles.

(c), (d) Two frames from the series of colour photographs of a low flying UFO taken by Paul Villa of Alberquerque, New Mexico, USA, on 16 June 1963. The best reproduction of this series is published in one of the earlier issues of OMNI magazine (probably 1979 issue). Selected photographs are also reproduced in [1S1.1], page 10 (in colour); [2S1.1] page 210, and [3S1.1] pages 110-111. The UFO illustrated above represents a detached configuration formed from two K7 type vehicles, whose manner of coupling is explained in Figures F10 and S1. The outlines of a lower vehicle, flying in the inverted position, are warped by the action of a magnetic lens and therefore only partially visible. In high quality copies of these photographs, eleven black bars running between the side propulsors of the lower and upper vehicle are clearly distinguishable. The shape of these black bars is unfortunately impossible to determine here. But in similar cases, eye witnesses have firmly reported them as square in cross-section (see subsection S1.1).



The ship that carried da Silva away.

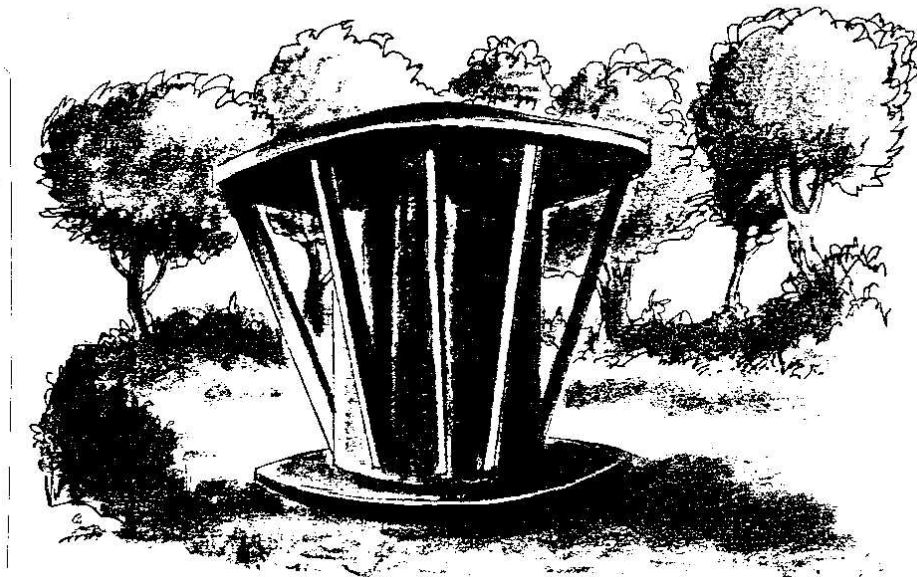

Fig. S2. "Black bars" in a UFO. The above diagram illustrates clearly that the black bars formed from a highly concentrated magnetic field yielded by the propulsors of a UFO are square in the cross-section. This in turn provides further evidence that the propulsors of UFOs utilize Oscillatory Chambers for the magnetic field production.

(Upper) A semi-attached configuration obtained through coupling together by their topside domes two type K3 vehicles, mutually facing each other (see also class #4 in Figure F6 and Figure P13). The Theory of the Magnocraft reveals that in such a configuration between the main propulsor of the lower craft and the side propulsors of the upper vehicle there must appear columns of a highly concentrated magnetic field that traps light and therefore are visible as "black bars" (shown on the sides of the above illustrated vehicle). The cross-section of these columns must reflect the shape of the devices used to generate the magnetic field, i.e. if Oscillatory Chambers are used for this purpose the cross-section of the columns must be a square.

(Lower) The diagram of a spool-shaped UFO presented in the book [5S1.1], page 11. It illustrates a witness's recollection of the spaceship which on May 9, 1969 abducted a soldier named Jose Antonio da Silva from Victoria, Brazil. He was found 4 days later in Bebedouro, 800 kilometres away. From the point of view of the Theory of the Magnocraft, the illustrated spaceship represents the semi-attached configuration shown in part (a) of this Figure. Because the "black bars" formed from the field of this UFO in fact have square cross-section, thus their outlines documented with this illustration provide further evidence that UFOs use Oscillatory Chambers for the magnetic field production.



Fig. S3. Outlines of a UFO's twin-chamber capsule scorched in grass. This photograph presents marks scorched by a UFO type K5 when it landed on the grass of a football field that belongs to the "Pirates Football Club", Dunedin, New Zealand. The UFO landed in the inverted position (see Figure S3 "b"), slightly slanted towards magnetic northward, and the outlet from its main propulsor almost touched the grass. Therefore marks that its propulsors scorched in the grass consist of two separate parts: (1) a slightly deformed (i.e. having a small concavity on its north side) ring of bare soil, 8.5 metres in outer diameter, and (2) a square mark burnt in the centre of this ring. (In the above photograph a reference circle of exactly 1 meter in diameter is placed to the left of this square mark, with its arrow pointing magnetic north.) The square mark has a side dimension of 1.55 meters, and an inner square of grass is left non-scorched inside it (the side dimension of this inner non-scorched square is 0.89 meters). This means that the UFO's main propulsor operated in the mode of "outer flux prevalence" - see Figure C6 "b". The landing took place around 15 January 1989, but I photographed this site on 17 February 1990. Apart from scorching the above landing marks, the same vehicle also flattened a large lamp located in the same football field and scorched a similar ring under it. Mrs Kathy Morrison (17 Taupo Street, Ravensbourne, Dunedin) witnessed this UFO when it approached the landing.

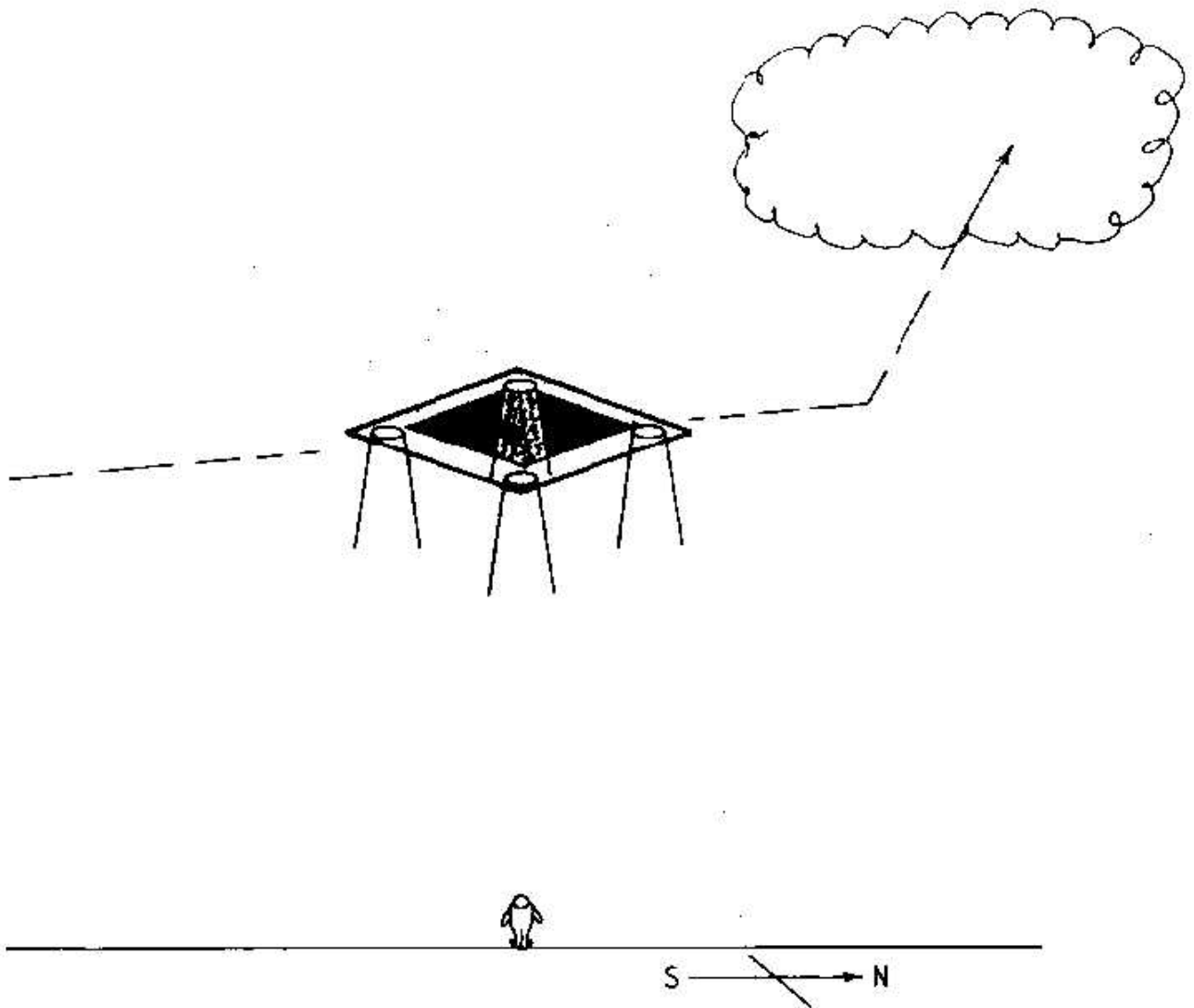

Fig. S4. A drawing of a main twin-chamber capsule from an ascending UFO. This capsule was seen by Mr Wayne Hill of Invercargill at 11:30 PM on 20 December 1978. It was observed directly from underneath, when hovering at the height of about 30 metres. It had the shape of two cubes, one inside the other, with their front outlets both facing the witness. The side dimension of the outer cube was about $a_M=10$ metres (this means that the observed UFO most probably was the type K9 - see dimension "a_M" in Table F1). The walls of the outer cube were lit by a yellow glow, whereas the inner one remained completely dark. This strong, yellow glow seemed to be more concentrated in the corners of the outer cube from which it shone downwards. The remaining, non-glowing space between both cubes was greyish in colour. The observation took place on a lone road about 7 kilometres south of Nelson, New Zealand, and lasted for about 20 seconds. Initially the UFO was flying in the south to north direction, and then stopped moving exactly above the witness - as it is shown in the drawing. The action of a magnetic lens hid the contour of the vehicle and only the outlines of both Oscillatory Chambers (i.e. inner dark and outer lit up) from the main propulsor remained visible - see the explanations in subsection F9.4.1 and Figure F32.

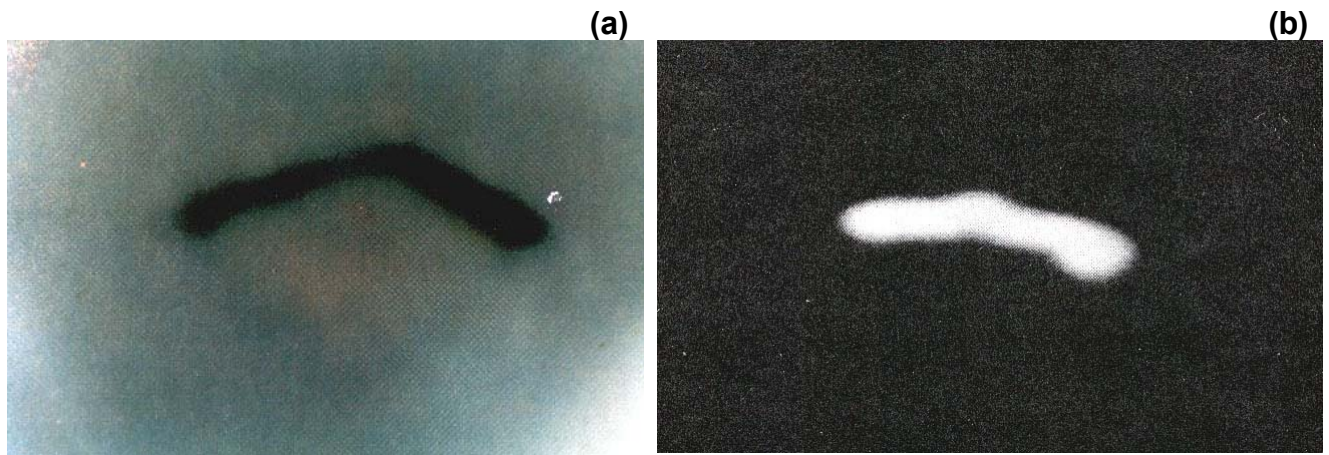

Fig. S5. Photographs of twin-chamber capsules from UFOs. Apart from proving that these configurations of Oscillatory Chambers are already used in UFOs, both photographs document also the "magnetic lens" effect formed by field of UFOs. The circumstances when such a magnetic lens effect appears to the photographer are explained in Figure F32. Notice that in both above cases the thickness of the space between the side edges of the outer " a_o " and inner " a_i " chamber fulfils the equation (C9): " $a_o = a_i \cdot \sqrt{3}$ " - see Figure C5.

(Left) One of the best colour photographs of a twin-chamber capsule from the main propulsor of an ascending UFO. It was taken by a teacher in Hawaii and subsequently published in the book [3S1.3], "Into the Unknown", Reader's Digest, Sydney, Australia, 1982, ISBN 0-909486-92-1, page 315. In the photograph above the vehicle's main magnetic circuits form an effective magnetic lens which dissipates the outer parts of the UFO - see also Figure F32. But because the central magnetic circuit radiates from this lens and forms a type of vision channel directed towards the photographer, the twin-chamber capsule that produced this circuit remains clearly visible. In the photographed capsule the resultant flux is provided by the inner chamber, whereas the entire output from the outer chamber is drawn into the circulating flux - see Figure C6 (a). Therefore in higher quality copies of this photograph, a cone-like column of a magnetic field yielded by the inner chamber can be clearly distinguished. This cone conceals the outlines of the remaining two edges of the capsule located behind it. The magnetic field bent by the outer chamber into the circulating flux has a clearly distinguishable boundary and therefore acts as a trap for light (see the description of "black bars" - subsection F3.4). Thus, the inside of the outer chamber is visible as a blackened area.

(Right) A night-time photograph of the twin chamber capsule from an ascending UFO, taken by a newspaper reporter over Clovis, New Mexico, on January 23, 1976 - see [5S1.1] page 49. The illustrated capsule operates in the mode of outer flux prevalence, the visual appearance of which is explained in Figure C6 (b). In this mode the resultant magnetic flux is produced by the outer Oscillatory Chamber, whereas the entire output of the inner chamber is bound into the circulating flux - see the explanations in Figure C5. In this way the resultant flux yield to the environment must strongly ionize the air, thus in night photographs it appears as thick, glowing edges of an outer diamond. On the other hand the circulating flux must produce a black inner diamond, which because of the darkness is not distinguishable from the similarly black background. Because of the orientation of the above capsule towards the photographer, two rear glowing edges of the outer diamond are hidden behind the non-transparent column of a magnetic field yield from the capsule. Therefore the above picture reveals only two front glowing edges of the outlet from a twin-chamber capsule which from a distance appears as a half-diamond.

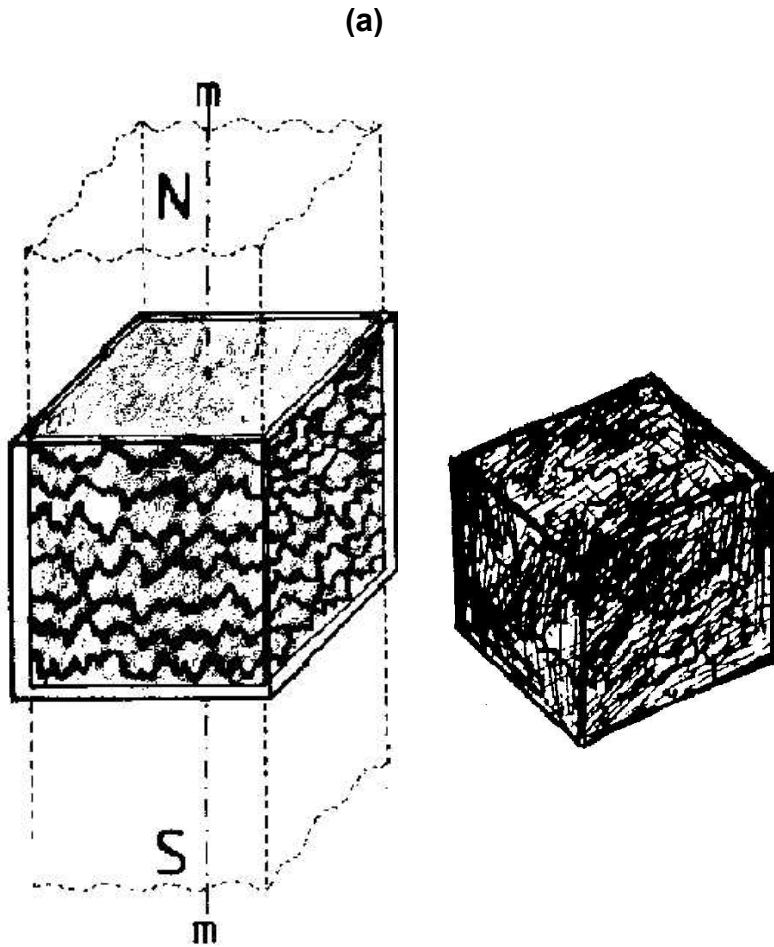

Figure 13. Glass or crystal cube with motionless black smoke and lightning

Fig. S6. A reconstruction of the Oscillatory Chamber seen on a UFO. This transparent cube was sighted by Mr Robert Luca on a UFO deck. It contained electric sparks which looked like lightnings frozen inside. (Compare this illustration with Figure C3 (a) that shows the appearance of such an Oscillatory Chamber.) The above diagram and description are reproduced from the book [2S1.4] by R. E. Fowler, "The Andreasson Affair, Phase Two" (Prentice-Hall, Inc., USA, ISBN 0-13-036624-2, page 70) by kind permission from Mrs Betty A. Luca, copyright holder. It presents the outer Oscillatory Chamber from the twin-chamber capsule which constituted the main propulsor of this UFO. The above illustration introduces a breakthrough in our certainty of the Magnocraft's principles, as it not only confirms through an eye-witness's report that the Oscillatory Chambers are already utilized in the propulsion of UFOs, but it also proves that our intention to built the Oscillatory Chamber on Earth is feasible and valid.

Here is how Mr Robert Luca describes this device in his report: "Then there's a box on the other side that's behind this bench and I can see from standing. It looks like a glass cube and it fascinates me 'cause it's filled with, looks like black smoke. It looks like there's lightning inside it or something gold. Looks like it has streaks of gold running all through it - a bright, bright gold. It's a cube, maybe not a yard square. No, it's less than three feet and it's got all little lightning bolts inside it. It's all black with these gold streaks running through it (Figure 13). It looks like the lightning has been frozen right in its path."

(a) The predicted appearance of the Oscillatory Chamber of the first generation (described in volume 2 of this monograph).

(b) The appearance of the working Oscillatory Chamber seen on deck of a UFO by Mr Robert Luca.

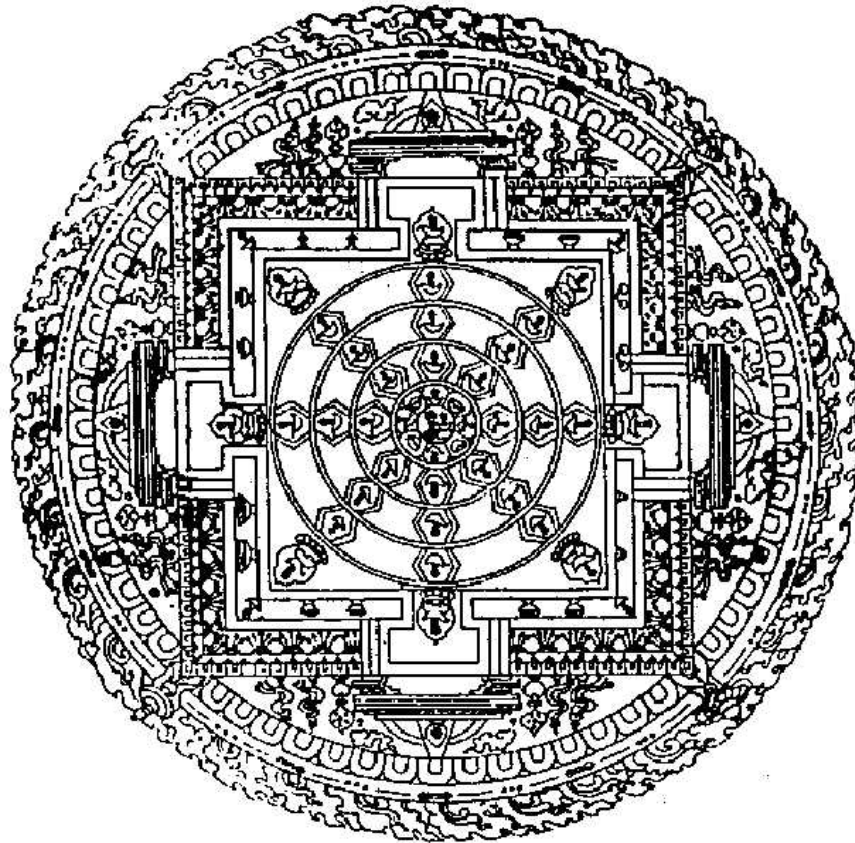

Fig. S7. A drawing that probably presents **an ancient diagram of the Oscillatory Chamber**. It was found in a manuscript originating from Tibetan Buddhists. It is possible that this symbolic drawing illustrates either a technical design of the Oscillatory Chamber, or the entire spherical propulsor containing such a chamber. While analysing this drawing, one may notice clusters of needles which exactly correspond to the following description of a UFO Oscillatory Chamber provided by Mrs Betty A. Luca (see the end of subsection S1.4): "inside had thin protruding stems with tiny glass droplets on the end".

In the course of later research I learned that Tibetan Buddhists from Nepal have a long tradition of producing technical drawings of this particular device. They call these drawings "Tanka". Tanka drawings are now even a kind of tourist attraction of Nepal.

It seems to be relevant to mention at this point that almost all ancient sculptures show Buddha as having extraordinary long ears (i.e. almost touching his shoulders), but the same sculptures show other people surrounding him as having normal, human ears. The Buddhist legend from China about the so-called "Eighteen Immortals" admits openly that people having such long ears were not ordinary mortals, but beings that show supernatural powers similar to those displayed by UFOonauts today. For example one of these Eighteen Immortals, named "Nantimitolo" or "Timing Dragon Lohan", who lived on Earth at the time when the King of the Sea flooded China (i.e. most probably at the time of the Tapanui Explosion - see [5]) was known from his ability to fly a mythological creature then called a "dragon" (which most probably represents one of a few ancient interpretations for UFO vehicles - see also subsection R4). On the other hand it is reported by numerous eye-witnesses that some UFOonauts have these kinds of ears. Although Buddha is recognized as a historical figure and in many present publications he is assigned a "human" biography, a significant number of facts about him remain unclear. Some ancient sources directly claim that he was one of the Immortals and held supernatural powers. Thus, such a vital anatomic difference as "ears of an Immortal" appearing on sculptures of Buddha could mean that his first priests had access to extraterrestrial technologies and in fact could know the design and operation of the Oscillatory Chamber.

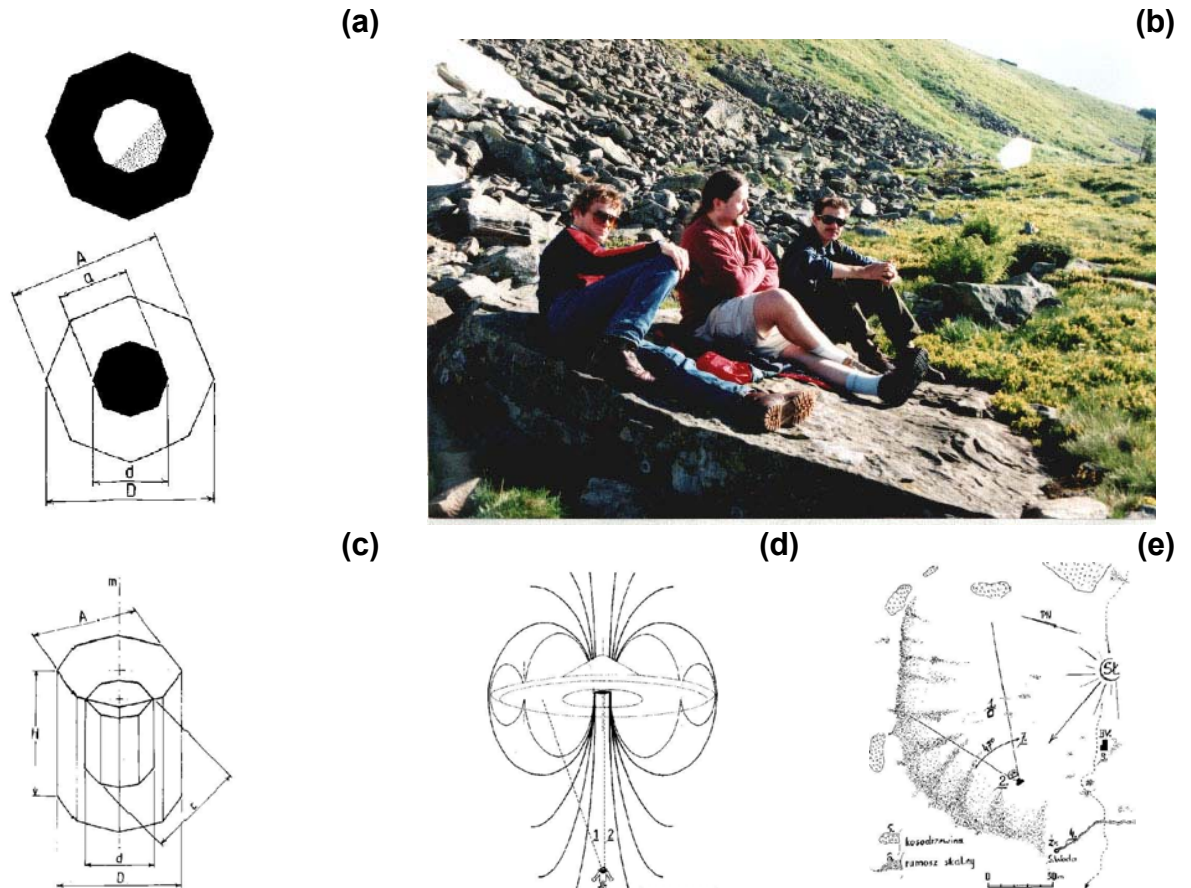

Fig. S8. The photograph of the outlet from the inner oscillatory chamber of the main propulsor of an invisible UFO of the second generation. It is shown together with supporting drawings that explain what this photograph actually represents. The UFO propulsor operates in the mode of inner flux prevalence. Interpretation of this photograph is provided in subsection S6.

(top right) A photograph of a fragment of outlet from the main propulsor of an invisible UFO. (Take the notice of the white 5 sized polygon visible in the top-right corner of the photograph.) This photo was taken from a tripod near the top of Babia Gora, Poland, on 5 July 1999 around 7:30 am, with a photo camera of Leszek Staszl, type Canon Eos 630. The original photo was intended as a group photo of participants of this research expedition, including (from left): Kazimierz Panszczyk, Leszek Staszl, and Ludwik Krzeczowski. But by an "accident" the photo recorded also evidence, that all research expeditions to Babia Gora aimed at finding the entrance to UFO tunnels located there, always are accompanied by invisible UFO vehicles, which with telepathic manipulations on minds of investigators make this finding more difficult.

(top left) Two outlets from propulsors of a UFO of the second generation, shown in both modes of operation. They have shapes of octagons that glow with like a supernatural, white, the so-called "extraction glow", identical to that which is captured on the above photograph. The dotted area is marking this fragment of the outlet from an inner chamber, which was captured on the photograph illustrated here.

(low left) The appearance of the twin-chamber capsule formed from two oscillatory chambers of the second generation (shown also as (2s) in Figure C8). It has the shape of a rod or column with octagonal cross-section, in the centre of which another similar rod of column is free floating.

(low centre) This Figure explains that within a powerful magnetic field that is produced by UFO vehicles, light moves exclusively along force lines of magnetic field, because this field performs for the light the function of a bundle of fibre-optic cables. Thus in order to see the outlet from a UFO propulsor as an octagon, the observer would need to look at it along the magnetic axis of the vehicle. But when this outlet is viewed under an angle, then not more than 40% of the entire surface of the octagon can be seen, and this surface is deformed by the curved path of magnetic field force lines (in a similar manner as a picture of an octagon would be deformed by deflection in a concave mirror). Exactly such a shape, i.e. slightly less than a half of a deformed octagon, or more strictly two edges of that octagon visible along the entire their length, and another two edges visible only partially, was captured on the above photograph.

(low right) A map of the area where the above photo was taken on the Babia Gora. Symbols: 1 - the UFO propulsor, 2 - photographed people, 3 - ruins of BV shelter, 4 - source of the stream called "Hungry Water", 5 - mountain shrubs, 6 - rock rubble, 7 - an angle of seeing by the camera lens (47 degrees).

Chapter T.**SIGHTINGS OF UFOs OF THE SECOND AND THIRD GENERATIONS**

There are three categories of evidence which confirm that our planet is also visited by UFOs of the second and third generations. These are:

1. Observations of Oscillatory Chambers taking the shape of an octagonal bar (i.e. with eight identical side walls), or even a "sixteen-sided" bar (i.e. chambers with as many as sixteen identical side walls). The enormous technological difficulties needed to be solved during the development of such advanced Oscillatory Chambers justify their application only for propelling the Magnocraft-like vehicles of the second and third generation - see subsections M6 and C3.1.

2. Observations of the telekinetic UFOs and personal propulsion of UFO-nauts the capabilities of which correspond to those foreseen for the Magnocraft of the second generation utilizing telekinetic propulsors.

3. Observations of the phenomena induced in the presence of UFOs and UFO-nauts which correspond to those foreseen to appear during the operation of Time Vehicles which represent the Magnocraft of the third generation.

An example of the observation that belongs to the first category was already described in subsection S1.4. In two subsections that follow the evidence accumulated for the last two categories is reviewed.

In connection with the topic of this chapter it should be added that there is also a number of observations accumulated already that describe in detail the so-called "beaming" of people onto decks of UFOs (see appendix Z for an example). One of the effects of this is that people subjected to it report later experiencing a significant loss of thermal energy, manifested through feeling cold, shaking, tingling of body, etc. This heat deprivation allows us to recognize that the phenomenon employed by UFO-nauts to create this beaming is the Telekinetic Effect (see subsections H6.1 and L2). On the other hand, all the manifestations accompanying this way of transporting; e.g. the strong emission of "extraction glow", psychic experiences, passing through solid objects, etc.; correspond exactly to the use of an advanced propulsion system based on the utilization of a "transporting beam" described before. These facts derived from UFO observations are consistent with the Concept of Dipolar Gravity and confirm that the transportation devices exploiting the telekinetic beam as indicated for stage 2D of subsection M6 are also in use by some advanced civilizations.

T1. Observations of Oscillatory Chambers of second and third generations

Quite a representative example of observation of an oscillatory chamber of the second generation was already reported in subsection S1.4 (see there the abduction of Gaynor).

Several further reports, that illustrated the use of oscillatory chambers of the second generation in UFOs, are contained in the excellent book [1T1] by Professor John E. Mack, M.D., entitled: "Abduction - human encounters with aliens", Ballantine Books - a division of Random House, Inc., New York, May 1995, ISBN 0-345-39300-7, Library of Congress Card Number 93-38116, volume 464 page. This book contains a best selection of reports from UFO abductions that I encountered in my research so-far. Thus I would recommend the reader to read it, because it provides an excellent selection of evidence in confirmation of theses of this monograph, including the messages contained in key subsections VB1 and A3. Also the circumstances connected with the book [1T1] support content of this monograph. For example, soon after this book was published, the Harvard Medical School in Cambridge, Massachusetts,

USA, where John E. Mack was employed as a Professor of psychiatry, arranged a special panel of experts, the visible task of which was to find a way (and an excuse) in which the university could "legally" dismiss him from the post that he occupied. (Obviously, he must be employed on the principle of a "tenure", which means that he could not be dismissed until he retires, or puts his resignation forward himself.) The presentation of activities of this panel was contained in several newspaper articles, amongst other in [2T1] "Harvard Prof under probe over alien abduction theory" published in a Malaysian newspaper The Sun (Sun Media Group, Sdn. Bhd., Lot 8, Lorong 51A/227B, Section 51A, 46100 Petaling Jaya, Selangor, Malaysia), issue dated on Sunday, 20 August 1995, page 43; or [3T1] "Mack attack", Fortean Times, vol. 83, page 29. (I believe it would be very helpful for the course of freedom of scientific research in New Zealand, if also the University of Otago from Dunedin, would firstly need to prove me a wrongdoing before it kicked me out from there in 1990 for carrying out the research on UFO explosion near Tapanui - as described in subsection A4. After all, since that kicking me out from the job, I am too scared to do any UFO research in open.)

One of the reports that illustrate the use of oscillatory chambers of the second generation in UFOs, contained on pages 150 and 151 of the book [1T1], refers to the use of an octagonal oscillatory chamber as a medical instrument that produces a healing telekinetic ray. (Other descriptions of just such a use of these chambers are provided at the beginning of subsection S1.4.) Here is what a person abducted to a UFO deck named "Carlos" reported on this subject:

"Whatever these crystals are, metal-like more than glasslike, there is light. I can see it {one of the particular crystal instruments used in the examinations}. It is like a squared tube of crystal with the sides lopped off so that at the ends, each tube appears eight-sided, but it is big in the middle and little on the edges, like it is mitered. And then the end of it is shaped like a step-pyramid. It shoots laser into the body, but it feels like a needle because it hurts, and it resembles a needle."

It is worth to add, that the use of telekinetic ray produced by such an octagonal oscillatory chamber causes an extremely fast healing of wounds - as this is explained in subsection NB4. In further part of the book [1T1] discussed here, there is even a clear confirmation of this fact - see page 401 of [1T1], the last paragraph:

"One man told me of a gash several inches deep that appeared on his leg following an abduction experience. Yet he said this cut virtually disappeared in twenty-four hours."

One of most interesting descriptions of the use of oscillatory chamber of the second generation from the main propulsor of a UFO for a healing purpose, is contained on page 53 of the above mentioned book [1T1]. We must remember that these oscillatory chambers produce a telekinetic field. Otherwise than the magnetic field yielded from the chambers of the first generation, telekinetic field not only that is not detrimental for human health, but actually improves this health - for details see subsection NB4. Thus in cases when in the parasitic interests of UFO-nauts lies the improvement of someone's health, UFO-nauts lead such an abducted person to the central column of the UFO vehicle that contains a telekinetic main propulsor. Over there they saturate the body of this person with the telekinetic field. This saturating practically depends on "floating" in the column of telekinetic field that comes out from the main propulsor of a UFO vehicle. Such people "float" on the telekinetic field in a manner almost identical like trainees parachuters "float" in the stream of air that is blown up from an aerodynamic tunnel. Here is how one of the people abducted to a UFO deck describes her experience during such a free "floating" above the main oscillatory chamber of the second generation from the main propulsor of a UFO. (Notice that in this description, similarly like in other ones from this monograph, the symbol ... marks places in which some insignificant for the content of this monograph fragment of text was left out.)

"The floor is open and hollow; the blackness comes from its depth; sort of; it is a place of movements, from within it, an energy or movement comes upward to where I 'stand' or float on it and it is like air, but it isn't a cold shaft of air or anything ... it, like ionizes me. I mean it is

like an electrical fabrication all through the outside of my body, and within the heat inside the generating crystal structure within the circular floor space is the core of light."

T2. Observations of telekinetic UFOs in operation

The findings of the theory named the "Concept of Dipolar Gravity" and described in chapters H and I, indicate exactly what are the most important attributes of propulsion systems that utilise the Telekinetic Effect. These attributes can be utilised for the direct identification of Telekinetic Vehicles and garments of Telekinetic Personal Propulsion. They also allow to distinguish between such telekinetic propulsion systems from all other propulsion systems of UFOs, especially from the fully magnetic propulsion systems of the first generation. The use of such telekinetic vehicles and garments should be quite easily identifiable, as they would display the following attributes absent in other propulsion systems:

#1. Extraction glow. When operating in the telekinetic convention, the surface of these vehicles and garments should be covered with a thin layer of white "extraction glow" or green "dispersion glow" - see subsection H6.1.2. The extraction glow is a cold and white light, very similar to the light of the Moon. In the old days this glow was considered to mark supernatural beings. It made them look as if they were "oiled with light".

#2. Passing through solid objects. Vehicles and garments operating in the telekinetic convention should be able to move through solid objects without damaging these objects or themselves.

#3. Becoming invisible. It is accomplished through the flickering between the material state and the telekinetic state. Details of this state of "telekinetic flickering" are described in subsection L2.

At this point it should be added here that there are also various attributes which **indirectly** certify the use of telekinetic propulsors in some UFOs. In order to give a frequent example of such attributes, one of them is the high biological activity of the Telekinetic Effect. It is explained in subsections NB2 and NB4. It causes that UFOs of the second (and also third) generation induce various long-term post-effects. In order to list some of these post-effects, they include almost an explosive increase in the speed of growth of vegetation sometimes even up to 12 times more than normal, mutations of organisms, the appearance of paranormal capabilities in some people, etc. Manifestations of these attributes, after UFOs were previously observed in the same area, are documented with a vast body of evidence. However, because of the indirect meaning of this evidence its further discussion will be omitted in this monograph.

Let us return to **direct** attributes. There is a wealth of evidence already available, which confirms the presence of attributes listed above in some contemporary UFO observations. This allows us to reason that some UFOs already utilize the telekinetic convention of operation. Let us now examine a few examples of evidence which confirms that some UFOs display the extraction glow, have the capability to pass through solid objects, and are invisible to human sight.

Re. #1. The extraction glow. There are numerous UFO photographs available which illustrate shapes corresponding exactly to those deduced for the Magnocraft, but in which the vehicle looks as if it is "oiled with light". An example of this is shown in **Figure T1**. In this photograph the light covering the surface of a UFO displays all the properties of the **extraction glow**. Moreover, the fact that a single frame shows twice the same vehicle, but moving discretely to two different locations, indicates that the vehicle moves in a telekinetic state - see subsection L1. The above is additionally reinforced by the fact that in any of the magnetic modes of the Magnocraft's operation, such as the magnetic whirl mode, throbbing mode, or magnetic lens mode, the appearance of the vehicle as in Figure T1 can not be induced. To conclude the above, in order to achieve all the attributes recorded in the photograph from Figure T1, the UFO needed to employ a technological version of telekinesis. Thus, the

photograph must show a UFO of the second or the third generation.

Garments of personal propulsion used by UFOonauts can also look as if they are "oiled with light". Such an appearance is reported in the following eye-witness report by Miss Jock Laing (7 Smith St., Roxburgh, Central Otago, New Zealand). The events reported by her took place one weekend in December 1958, when she was 9 years old.

"I was lying on my bed and reading a book. The bed was a heavy construction, made of brass, with three horizontal bars at the foot of the bed. Behind the foot of the bed there was a window, closed that day, through which branches of a huge apple tree could be seen. For some unknown reason I lifted my eyes from the book and saw three little beings of about 85 cm in height, dressed in shiny, radiant clothes. They were suspended in the air, exactly in the place where the three horizontal bars at the foot of the bed were located. The metal of these bars penetrated through their bodies. The outlines of these beings were also unusual. The entire surface of their bodies and clothes was covered with a thin layer of white light. This light made their outlines quite fuzzy. The beings were not intimidating, and somehow I felt a calmness and friendliness emanating from them. They communicated with me without a sound - just by putting the information straight into my head. When they finished this silent talk, they departed rapidly, still facing in my direction. They accelerated backwards in a straight line, passing through the glass of the closed window and through branches of a tree behind it. The brass of my bed displayed no damage afterwards. Also the glass in the window was untouched. When I described the events to my family they laughed at me, telling me that I was too old to see fairies. No-one had heard about UFOonauts in those days."

In the above observation both attributes unique to the use of telekinetic propulsion systems were confirmed, i.e. the appearance of the extraction glow on the surface of the personal propulsion garments, and the ability to **penetrate solid matter** without any damage to that matter or to the UFOonauts themselves.

Probably it is also worth mentioning here that in 1987 I conducted a research of UFO landing sites in the Roxburgh area. Some of the landings investigated there are presented in Figure Q12 of monograph [1]. On the slope of the hill range behind the garden of Miss Laing, I noticed numerous (not only one) old landings of a UFO type K4 (with the strict policy of UFOonauts that at least one crew member must always remain inside the vehicle, UFOs type K4 have three out of four crew members capable of visiting someone - see Table F1). These landings could have been scorched in 1958. Their extremely high biological activity still clearly noticeable in 1987 suggested that they originated from telekinetic UFOs.

When discussing the case of Miss Laing it should be noted that the event took place when she was 9 years old. Also a significant proportion of other close encounters with UFOonauts involve 9 year olds. I analysed possible reasons why at that particular age UFOonauts seem to willingly appear to children, and I came to the conclusion that the reason must be the height of people. Nine-year olds on average are approximately around the same height as Zeta Reticuli UFOonauts (i.e. 90 to 110 cm). Thus UFOonauts must somehow relate better to people of equal size to themselves and probably this prompts them psychologically to appear to these youngsters more often than to other people.

Re. #2. Passing through solid objects. The ability of UFO propulsion to pass through solid objects is emphasized in many observations. This ability, together with other attributes of telekinetic propulsors similar to these from case of Miss Jock Laing, were revealed in another case of the use of telekinetic personal propulsion, known to me. On the night of 29 May 1983, at 1:30 a.m., Mr Witold Rusek, ul. Wiktorska, Warsaw, Poland, was abducted by two UFOonauts onto the deck of a spherical UFO complex (similar to the one shown in Figure P9) where he was subjected to a medical examination. Here are some excerpts from his written report describing the event.

"... I stayed near the window in my room and observed this huge sphere, with two black horizontal flanges fastened round the middle of it, which gently hovered above the ground, emanating a brown-red colour. ... Rapidly from the wall near my window emerged two beings

about 2 metres high, dressed in white glowing garments. ... They grabbed my wrists and began to pull me in the direction of the wall. It terrified me because I could become stuck inside the wall. But when I thought this, they sent back to me, probably telepathically, the feeling of their amusement and this relaxed my resistance. ... Inside the spaceship there was a square room, the ceiling of which curved on one side into a wall. ... On one of the walls protruded something that appeared to me to be like a square window. I tried to look through it but I could not see anything. ..."

The last two sentences of this excerpt concern the observation of the Oscillatory Chamber, and are connected with the content of subsection S1. It is pity that the eyes of this observer were adjusted for distant seeing, otherwise perhaps we would have another report of observation of an octagonal (or even "sixteen-sided") Oscillatory Chamber. In the above report it is also worth to notice the use of TRI of the first generation described in subsection N3.1. It was used to telepathically pass feelings.

There are also opposite situations reported, when UFO-nauts are motionless, whereas material objects (e.g. people) penetrate through them. A highly evidential observation which clearly confirms such an ability of UFO-nauts was made on Starr Hill, Warminster, England (this observation is described in **[1T2]** Nigel Blundell, Roger Boar: "The World's Greatest UFO Mysteries". Octopus Books Limited, London 1983, ISBN 0-7064-1770-4, page 132). In the incident a team of eight witnesses was present, which included Sally Pike, who reported it, and her husband Neil. The witnesses had spotted two high-flying UFOs when they all felt the air become warmer (compare the conversion of thermal energy during telekinetic release - subsection H6.1.2). Then two aliens appeared. They were about 2 metres tall, and it was as if they were made of smoke (see transparent properties of telekinetic state - subsection L2). The observing team could see their outlines down to their waists, then they gradually started to dissipate. When Neil approached them, he seemed to blend in with them. He couldn't see them when he got close, but the team of observers watched him walk straight through the figures and out the other side. The aliens remained in the same place for about half-an-hour, then disappeared.

A similar observation of passing an UFO-naut through a car, is described in the article **[2T2]** by Bronislaw Bzowski, "UFO nad ZSRR", that was published in the Polish monthly Nie z tej Ziemi, no. 2, 1992, pages 27-29. This observation includes all components of the use of telekinetic personal propulsion system. It reports on an event that took place on 26 June 1989 in the city Lesozawodsk, from Nadmorski Kraj, Far East, Russia. Here is how these events were described there (in my translation from Polish):

"The alien still walked along the centre of the road, turning his head to the right and left, like looking around. Rapidly on the road a car appeared, driven by a young male. The driver noticed the alien and started to break. But something unexpected happened. The alien took several steps in the direction of car, and the car drove through him. The scared driver stopped the car after around 15 meters, clamping his fists on the steering wheel. Both, he - especially his hair, and his car, were covered with silver dust. In that moment legs of the alien disappeared, although he himself still walked and disappeared only on the bridge. Girls saw all this while hiding behind the buss stop..."

Independently from the record of physical penetration of one object by other object, without harming any of them, the above description contains several interesting observations concerning technical telekinesis. One of these is the observation of the visual byproduct of the action of telekinetic field. This byproduct is the "extraction glow", that appears on objects and materials which were in contact with powerful telekinetic field produced by UFO propulsion. So the above report represents an eye witness confirmation which confirms the ability of the UFO telekinetic field to temporally telekinetise of all objects that are in contact with this field - for details see subsection NB1. It is this silver glow of the air powerfully telekinetised by oscillatory chambers of the second generation used in "magical rods" of ancient "wizards" and "witches", that induced the folklore stories about "magical silver dust" that is spread by "magical rods" of

these aliens. Another interesting observation, is the reliability of the instant reaction of the controlling computer from this personal propulsion used by the alien. After the alien found himself in a dangerous situation, his personal propulsion system automatically increased the frequency of the "telekinetic flickering". In this way, the ability of this alien to penetrate through moving objects was increased. In turn, according to descriptions from subsection L2, the higher frequency of the telekinetic flickering caused the decrease in the visibility of this alien. So the alien partially disappeared around propulsors in his legs.

Re. #3. Becoming invisible. There is a lot of observations that document the ability of UFOs of the second and third generations to become invisible. These UFOs accomplish such invisibility through going into the state of telekinetic flickering. An example of such observations can be adventures of "L family" described in subsection U3.5. An entire UFO vehicle was entering their house every three months. Amongst a large selection of such reports, the special attention we should pay to these ones, that document and explain the manner in which UFOs become invisible.

One of the best documentation of becoming invisible, is presented on pages 351 to 352 of previously mentioned book [1T1]. In this particular case, a person abducted to a UFO named "Carlos" describes how he was placed on an oscillatory chamber from the main propulsor of a UFO. This chamber looked to him like a crystal structure. In the effect of being placed on this oscillatory chamber, the body of Carlos gradually transformed into what for him looked like light. This means that from a physical state, he transformed into the telekinetic state - for details see subsection L2. Then his body become transparent. This person was also aware, that in the exactly the same manner UFO vehicles become invisible to hide themselves from humans. Here is what exactly Carlos reported in on this topic:

- "The crystal 'table' was used during examinations..., i.e. that particular symbol comes forth and we infer it as a table per se ... The large crystal structure, however, is located in the center of the lower rotunda area, and is a different mechanism; it is operationally and functionally distinct from the smaller instruments utilized in the exams. ... I went through that body - cracking (apart) ... First the light is the body. It (the light mechanism) continues (invading and permeating the interior of the body - muscles, tissue, organs, blood, nerves, et cetera) to the edge right next to the skin; it is when the skin dissolves ... This process is associated with itching. ... In this time, I am golden light. ... I am seeing my (own) inside (i.e. body interior) ... I saw the crystal-clear form of me. It is the ghost image I referred to earlier ... Carlos feels somehow that this process of transmuting his body into light is related to 'the process of... hiding (making invisible) the spacecraft'."

In the same book [1T1] several further descriptions are provided, which prove that becoming invisible, and also walking through walls, is accomplished due to a fast flickering, or vibrating, between the physical state and the telekinetic state. Means it occurs exactly in the manner as it is described in subsection L2. The key to the observation of the mechanism of this telekinetic flickering is the feeling of a powerful vibratory itching of the body of person who went through this process. A best such description is contained on page 19. Here is the appropriate quotation:

- "They are usually astonished to discover that they are passed through solid objects, experiencing only a slight vibratory sensation. In most cases the beam of light seems to serve as an energy source or 'ramp' for transporting the abductee from the place where the abduction starts to a waiting vehicle."

The above quotation documents, that people who walk through walls feel a sensation of fast vibrations of their bodies. These vibrations originate from the fact, that in the physical state their bodies are hold back by the wall, and thus they can only move after reaching the telekinetic state. Thus the entire process of walking through solid objects is composed of many subsequent pulls and halts at the moments of pulsatory change of states. By a given person these must be felt as vibrations and internal itching of the body. Notice that physical objects through which such a person walks, such as e.g. windows or gates, also may experience such

noisy vibrations if they are loose in their frames.

T3. The evidence confirming the existence of UFOs that operate as Time Vehicles

Various UFO sightings and photographs provided a significant body of evidence which confirms that some UFOs visiting our planet already operate as Time Vehicles (photographs of time vehicles are shown in **Figure T2**). This evidence can be classified into the following categories:

#1. UFOonauts' statements. Various UFO abductees reported that UFOonauts claim their vehicles to be capable of time travel, and sometimes even explain the phenomena and principles which such travel involves.

#2. The documented cases of time acceleration or deceleration. These are observed on wristwatches of people having close encounters with UFOs. Such watches registered time which was significantly accelerated or delayed in comparison to the time shown by other clocks.

#3. Cases of abductions onto a UFO deck which belong to the category of "one way trips". Such trips do not have their time - see descriptions from subsection M1. Therefore they take less time than the timespan of individual activities which were completed during these abductions.

#4. Cases of the "duplication of time". This effect is described in subsection M1.

#5. Reports from observations of the "state of suspended animation". This state is described in subsection M1. It can be caused only as the result of the operation of Time Vehicles.

Reviewed below are examples of the most representative evidence belonging to each one of these categories.

Re. #1. UFOonauts' statements. An example of an UFOonaut's statement claiming the capability of their vehicle to travel in time is supplied by a New Zealand citizen, in this monograph referred as Miss Nosbocaj, abducted onto a UFO deck (her case is reported in subsection U6 from volume 15 of this monograph). A few selected statements from her report are repeated below (the full content of this report is provided in appendix Z - see phrases N-126 to N-132, N-140 and N-162). The excerpt quoted is limited only to the alien's explanations concerning time travel. The person reporting refers to the alien guide who provided these explanations as "he".

"He told me about time too, that **time - actually doesn't move but we move over time**, so that he can actually meet me once - or come together once, but we can meet many times. So he can actually meet me in the future as well, so sometimes when I get the feeling that I've been to see him at night or something I only have met him once but, and we come together once at that point or that's, but, but you see because time doesn't move he can, he can, oh how can I explain this. But those points are there for him to be at when I pass through them, and that's why I sometimes get the impression that he's there again.

... He told me so much about, or showed me the way time works and space and things but I, I just haven't got the words. ...

He showed me but he, their navigating is so, is so different because they actually, they're operating more on, on more than three dimensional, it's five, six, seven, it's, it's because they're going through space and through time ...".

Notice that in the above quotation the capability of alien vehicles to travel in time is definitely confirmed by an alien himself. Moreover, this quotation reveals that the aliens' understanding of time very closely corresponds to that derived from the concept of Dipolar Gravity - compare the first (highlighted) statement in the above quotation with the content of subsection H9.1.

Re. #2. The documented cases of time acceleration or deceleration. A case of

accelerating time as shown by a wristwatch after a close encounter with a huge UFO, is well illustrated by the so-called "Kentucky abduction" that took place near Hustonville, Kentucky, on 31 January 1976. This abduction involved three women: Louise Smith, Mona Stafford and Elaine Thomas. Quoted below is a sentence taken from the report that describes this abduction (see [1T3] Ronald D. Story (editor): "The Encyclopedia of UFOs". New English Library, London 1980, ISBN 0-450-04118-2, page 193):

"Prior to washing her hands, Louise had taken off her watch and was startled to see that the hands of her watch were moving at an accelerated rate of speed, the minute hand moving at the speed of a second hand, and the hour hand was moving also."

Re. #3. Cases of abductions onto a UFO deck which belong to the category of "one way trips". An example of abduction which belongs to a "one way trip" type, thus which took less time than the duration of individual activities taking place during it, is the case of the abduction of Carl Higdon that took place on October 25, 1974. This case is described in the book [1T3] by Ronald D. Story (editor): "The Encyclopedia of UFOs". New English Library, London 1980, ISBN 0-450-04118-2, page 171, and in the book [2T3] by Joshua Strickland: "There are aliens on earth! Encounters" (Grosset & Dunlop, New York, 1979, ISBN 0-448-15078-6), page 16. Here is a brief description of events taking place during Higdon's abduction - compare this description with the description under Figure R4:

About 4:15 p.m. he began elk hunting on the north edge of the Medicine Bow National Forest, south of Rawlins, Wyoming, USA. "I walked over this hill and saw five elk. I raised my rifle and fired, but the bullet only went about fifty feet and dropped." When picking up the bullet he noticed a man standing near by. The appearance of this man is illustrated in Figure R4. The man called himself "Ausso". Ausso gave Higdon a pill which he said was to satisfy his hunger for four days. Then he took him into a transparent cubicle (i.e. four-propulsor UFO, see Figures Q1 to Q3). Inside was another similar alien. After they took off, Higdon saw a basket-ball-shaped object under the cubicle, which he took to be Earth. Ausso said they had travelled 163,000 "light miles". They landed near a strange tower with a bright, dazzling light. There were five human-like people around. Ausso took him into the tower and subjected him to what looked like an X-ray. Afterwards he announced that Higdon was not what they needed and that they would take him back. He placed Higdon on the seat inside his cubicle and moved a control lever. Instantaneously, without any noticeable travel, Higdon found himself in the same place where he picked up his bullet, prior to his unusual encounter. Time seemed to shift backward to the beginning of his experience. At this moment Higdon didn't know who or where he was. He started to wander around, walking about a mile past his truck. This walk was estimated to take him over two hours. Then he returned to the truck and about 6:30 p.m. he called for help by CB radio. He was taken to hospital where he had no appetite for another 3 days. He displayed symptoms of exposure to some kind of radiation.

By our measure of time Higdon's entire abduction took only about 2 hours, i.e. between 4:15 p.m. (when he began his elk hunt) and 6:30 p.m. (when he called on the CB radio after returning to his truck). But during this time he visited his abductor's planet, was medically examined, returned back to Earth, had a long wander in the forest, found his car and called for help. Even if the speed of his abductor's vehicle was hundreds of times that of the speed of light, reaching a planet from a distant star in less than 2 hours would be impossible. On the other hand, all the other elements of Higdon's story, including the personal propulsion of his abductor - see Figure R4, were confirmed by the evidence. So there is no reason to dismiss his report of visiting the alien's planet. But to make this possible, some form of time travel (e.g. reversing backward the elapse of time) must be involved. Thus, the abduction of Carl Higdon provides further evidence confirming the ability of some UFOs to time travel.

It is worth mentioning that also the abduction of Miss Nosbocaj reported in appendix Z of monograph [2e] also had the character of a "one way trip".

One of the extremely vital aspects of the abduction of Higdon, is the reason for which he was abducted. This reason is directly connected with the subject of this monograph.

Therefore it requires addressing here. It is not difficult to deduce, that he was abducted in order to become a donor of some biological materials or resources. For example, his tissues or internal organs were required for transplants. Only the fact that from the medical point of view his characteristic was colliding with the needs of UFOonauts, saved him from being robbed from these materials. So his case is directly supporting the thesis presented in subsections A3, VB1, and U4.1, that "UFOonauts rob humans from biological resources".

Of course, the additional question that immediately arises here, is what would happen to Higdon, if he turned out to be the carrier of the required biological material. Would he survive the robbery of the required tissues or organs? After all, if we hypothetically assume, that becoming a donor would mean for him the end of life, then his possible fate must be shared by many other people. We know that his abduction was not an exceptional case. As this is explained in subsection O6, many other people are abducted in a similar manner from wild areas of Earth, to never return. Police chronicles of almost every country repetitively notice such unexplained disappearances of people in quite mysterious circumstances. Their disappearances also display a high similarity to Higdon's case. In the face of facts presented in this monograph, there is about time we start consider such possibilities. The legal aspect which awaits addressing as the first priority, is whether governments of countries, which ignore the duty to protect their citizens from UFO abductions, are obliged to pay a financial compensation to families of people who never returned from such UFO abductions.

Another vital aspect worth addressing in the abduction of Higdon, is the "human" appearance of "Ausso". In spite of being an UFOonaut, with the appearance and with the anatomic build up Ausso resembled humans. This in turn documents the correctness of theses from subsections A3, V1, V3, and P6, which state that "UFOonauts are our cosmic relatives", "people were relocated to Earth from a planet around 4 times larger than Earth", and "in various parts of the universe still relatives of humans live, from which our civilisation originates". Of course, while considering these theses, we also need to remember about the thesis from subsection A3. Namely that our cosmic relatives from UFOs are actually "black sheep" of the human family. They practice the philosophy of evil parasitism, and in a hidden manner they rob humans from everything for which they find any use.

Re. #4. Cases of the "duplication of time". One of the best cases of multiple observation of an effect, which in subsection M1 was called "the effect of duplication of time" was reported by a New Zealand abductee with the initials J.W. He asked me not to publish his full name or address. Mr J.W. lives alone in an isolated wooden cottage by the sea in a suburb of Dunedin. The lawn growing around his cottage is continually covered with many biologically active, visibly new UFO landing sites. In order for a given landing site to be biologically active, it must be made by a UFO of the third, or at least the second generation. For details see the biological action of the Telekinetic Effect summarized in subsection NB4. After detailed research it turned out that J.W. is systematically abducted onto the deck of an invisible UFO of the third generation, i.e. a Time Vehicle. Unfortunately his memory is always thoroughly and effectively "erased" after each of these abductions. He has, however, an awareness of UFOonauts taking him away, and even believes that he knows the purpose. According to his claims, his sperm is being taken for reproductive purposes. So J.W. belongs to the category of "sperm donors" described in subsection U4.1. After each abduction, he is put back into his cottage while still in a hypnotic trance. Sometimes he is left in a standing position. Then a waking up impulse is sent to him. When J.W. is woken up, an invisible UFO still stays in his vicinity for a few further minutes. As J.W. believes, most probably a UFO is doing it to make sure that he is O.K. This proof of being concerned about his wellbeing continually demonstrated to him by a UFO, immensely impresses J.W. During each talk with me he always stresses this fact, adding a comment along the line, quote "sometimes I am upset with them that they do not ask me for permission to do their sperm gathering, but I must admit that they show an unusual decency by making sure before the departure that all is o'right with me". But J.W. does not know, that UFOonauts do not show the concern about his health at all, but

only about the karma that they generate for themselves. They want, that when the time comes that they are going to be examined by someone, this someone makes sure before the departure, that they are OK. After awaking J.W. the invisible UFO departs. At the moment of its departure J.W. always experiences the "effect of duplication of time". Whatever he would be doing at this particular moment of time, or whatever he would be listening or watching, it always repeated itself twice, with the ideal correspondence of details. For example, when he watched a car with his neighbours passing by his window, a moment later the same car with the same neighbours dressed in the same way passed again by his window. The repetition is only a short period of time, around 15 seconds.

It is worth mentioning here several interesting aspects of this case. The first is that J.W. has a characteristic mark on the right side of his right shin. The mark lies a half way between the knee and ankle. Actually he was the first person systematically abducted to a UFO, which informed me that after one of his abductions he returned with this unique scar on his leg. It was the examination of his leg that inspired me later to a systematic examination of legs of all other people abducted to UFOs that I knew at that time. In the result of his inspiration, and also due to a "coincidence" that at the same time I just was carrying research of a number of different people abducted to UFOs and thus I could check also their legs, that I managed to accomplish an important discovery. Namely I discovered, that just such clear scars on legs have almost all people systematically abducted to UFOs. Only that woman have it on the left side of their left shin. This in turn gradually led me to discoveries described in subsection U3.1 and U4.1, and in chapter W of this monograph.

The second interesting aspect is that his abductions occur in such regular intervals, that J.W. knows their next date and time. Thus a few times, when the appropriate date approached, myself, equipped with all necessary instruments, waited in his cottage. However, UFOs never completed the abduction until I definitely, not only apparently, gave up and departed.

Another interesting aspect of this case are **vibrations of the house** in which J.W. lived. This house was made of wooden planks covered with metal sheets. In times just preceding a subsequent abduction of J.W., this house was experiencing powerful vibrations. These vibrations waned. Means that with a rhythm that was significantly slower than human breathing, they kept intensifying and then diminishing. They make an impression as if a UFO vehicle which arrived in the state of telekinetic flickering to abduct J.W., rhythmically kept descending and entering the house, inducing these vibrations, then again ascended, so that these vibrations diminished. But from my later research on effects caused by invisible UFOs on my own TV set, I discovered that the reason for this "waving of vibrations", is the waving of frequency and power of UFO's field. Namely an invisible UFO vehicle most probably remained inside of the house all the time. But the frequency and power of pulsations of the field that caused the telekinetic flickering of this vehicle, was changing in a wavy manner. In turn this waving of the frequency and power of UFO's field caused that the covered with metal plates wooden house of J.W. also was falling into resonance with the field of this UFO in a wavy manner. Between us, this wavy intensification and diminishing of the frequency and power of UFO fields, has something to do with the principle used to control the output from twin-chamber capsules of these vehicles - for details see subsection C7.1. It is reported in a large number of UFO observations, for example see the description of a "dog with constipation" provided in subsection O5.4 of this monograph, or the description of waving of the height on which a UFO hovered in an underground chamber - reported in subsection O5.3.3. Sometimes it is even captured on photographs - e.g. see differences in thicknesses of subsequent ionised layers of the air shown in Figure P18. In turn the mechanism of passing these pulsations of the UFO field onto vibrations of the wooden house of J.W., is exactly the same as the mechanism of vibrations and itching of human body during the telekinetic penetration of people through solid walls. In details this mechanism is described in subsection T2, while theoretically it is elaborated in subsection L2 of this monograph. Vibrations of the house of J.W. in some cases were so intensive, that cups hanging on walls were rattling against these walls. Unfortunately,

whenever I tried to register them, a UFO that was abducting J.W. always detected my presence in the house and would not fly inside of this house until I definitively departed. If I tried to trick it by an apparent departure and then return, the UFO always without an error awaited with the arrival until the moment of my definitive departure. The manner in which it kept occurring suggested to me that this UFO either checked earlier the future, or secretly watched me and my thoughts to detect my definitive departure.

Re. #5. Reports from observations of the "state of suspended animation". An excellent observation of the "state of suspended animation" is provided by a person using the pseudonyme "Richard Williams" (his real name is suppressed on his request) of Dunedin, New Zealand. Here is how he describes his experience (a spoken record of his observation is contained in my files):

"The events that I am reporting took place on one week day in July 1975 (most probably on Tuesday, 12 July 1975) around 12:50 p.m. As well as myself, it was witnessed by three of my friends, namely Pat S., Nancy T., and Ross K. Because all of them used to be well known figures in Dunedin, I will not reveal their full names. That day four of us had lunch together in a coffee bar, "Stewarts", located on the south side of Dunedin's Octagon. This lunch was one of many that we have together in the same coffee bar, as our everyday meetings here had a long tradition. On that particular day our conversation didn't spark, as the weather was cold and damp, Pat had flu, Nancy had migraine, Ross cut the top of his finger, and I had a headache. We sat around our table located opposite the stairs and quietly ate our lunches. All of a sudden time stood still. The noisy and busy coffee bar occupied by about 80 people turned into an absolutely silent place where everything froze. This looked like a still frame from a movie film. People were twisted in strange positions, frozen whilst performing movements. Their bodies looked comic and their positions seemed to be very unstable. I remember a cloud of steam suspended motionlessly in a dynamic configuration above the espresso machine. I also remember a waitress pulling out burning hot cakes from the oven, and sustaining their heat in the motionless hands. In the whole café only four of us seemed to remain non-affected, thus having the occasion to observe what actually happened.

At the top of the stairs that led down to the coffee bar from street level, an unusual man appeared. He was about 1.75 metres high and looked about 19 years old. He was dark, thin, with olive skin and black wavy hair {according to later Richard's comments he actually looked like a twin brother of TV magician David Copperfield, or famous spoon-bender Uri Geller}. His clothes looked normal, but displayed high taste and elegance. Everything about him looked strikingly perfect. The man was surrounded by a beautiful white glow, especially around his head and chest. The light seemed to be emitted not from him, but from the air that surrounded him. He glided down the stairs without moving his legs. He actually floated in the air slightly above the level of the stairs. Then he moved to the counter and stood first in the queue. As soon as he got there, everything started to happen normally again. People continued their actions from the point when they were suspended in motion. Steam continued to rush from the espresso. Everything looked as though nothing had happened. The man bought a glass of fruit juice and sat at the last free chair left at a 12 person table. He acknowledged our attention by a smile. We wanted to talk to him and find out more about his unusual arrival, but there was no access to his chair. So we decided to leave the coffee bar and wait for him upstairs at the only way out. After about 5 minutes waiting and not seeing him pass, I went back down to find that he was gone. There is no other exit from this coffee bar. This day we were also surprised to find out that Pat's flu and Nancy's migraine were gone, I had no more headache, and the top of Ross's finger looked as though it never had been cut.

We talked about this experience almost continually, and really wanted to learn more about this unusual young man. About six weeks later we spotted him again. He stood at the top of the stairs, intending to enter the café. He moved his head in our direction in a kind of greeting. His clothes were the same, except that this time he was surrounded by a faint green glow (not white). When he appeared nothing actually happened. He walked down as normal

people do (his steps looked somehow more light then ours) unnoticed by anyone but us. He again bought a glass of fruit juice and again sat in the same place. A few times he acknowledged our attention by a friendly look at us. This time we decided to interrupt him, and to find out who he was. We wanted to stand up and come closer, but none of us could move. When finally we managed to stand up, we directed ourselves out of the coffee bar (seemingly against our will). Pat desperately tried to turn back to him, but her efforts failed. After a while Pat decided to return back to the coffee bar, only to find out that he had already gone. We never met him again. The experience shook our lives and has remained the deepest mystery."

The above mystery was resolved on 1 October 1988, when Richard Williams described these unusual events to me. In the impulse of the moment I read to him the paragraph (in this monograph presented in subsection M1) which describes the "state of suspended animation". I previously described this state theoretically, solely from the analysis of the operation of Time Vehicles. Thus, Richard was the first person known to me who actually witnessed this state, without any prior knowledge of the theory behind it. Therefore his report provides an extremely valuable confirmation that Time Vehicles in fact already do exist.

In March 1989 I discussed the "state of suspended animation" with Mr. Mac X. of Waikouaiti near Dunedin. During this discussion Mac admitted that he also witnessed such a state. Unfortunately, because of various pressures, he was unable to give a written or a recorded report as to what he has seen. But he was willing to describe verbally his experience. Mac's observation had a very similar course to that of Richard B. It occurred around 11 a.m. one week day, sometime between June and August 1976. During the experience Mac was sitting at the table nearest to the stairs in the Dunedin coffee bar, "Stewarts", drinking his coffee. His attention was alerted when an unusual silence fell on the busy coffee bar. He witnessed all the people in the coffee bar, except for himself, frozen motionlessly for about 4 minutes in extremely uncomfortable positions. It is worth mentioning here that Richard and Mac X. never met and remained unaware of each others independent observation of so similar events. The only attribute they had in common was that they sat at the same table situated nearest to the stairs in the coffee bar Stewarts.

T4. The level of technology in UFOs of the second and third generation

It is worth emphasizing, that civilisations capable of building UFO vehicles of the second and third generation, most probably also reached equally advanced level in many other areas of the science and technology. Thus many of technical devices described in this monograph must already be utilised practically by such technically highly advanced, although morally decadent, civilisations of UFOonauts. To the most significant evidence of mastery by UFOonauts of these devices of the second and third generation, can be included:

#1. Telekinetic batteries. Such batteries represent the second generation of magnetic generators of electricity. They can be observed on decks of UFOs, and are described by UFOonauts. For description of these devices see subsection K2.4.

#2. Various devices that represent TRI of the second generation. These can be utilised by UFOonauts for various purposes assigned to them. TRI of the second generation are interfaces that recognise thoughts, which also allow to identify feelings and experiences - for details see descriptions from subsection N3.2.

#3. Demonstration chambers. These exist on every larger UFO and are demonstrated to a significant number of people that are aware of their abductions to a UFO deck. The description of these chambers is provided in subsection N3.2.

#4. Telekinetic tractor beam. It is used for transporting people from the surface of Earth to decks of UFOs. It is described in subsections L6 and H6.2.1.

In this subsection we are going to review several examples of observations of these advanced devices on UFO decks.

Re. #1. **Telekinetic batteries.** One of the more advanced devices discussed in this monograph is a telekinetic battery discussed in subsection K2.4.1. This battery has an unique shape of a laminated pyramid, empty inside, which produces electric energy without consuming any fuel or other form of energy. Thus people who would see it on decks of UFOs should remember it easily because of this special shape and functions.

A telekinetic battery was in fact seen on a UFO deck by someone who wished to be named Richard Williams. He was one of the first people that I get to know in person in New Zealand, who was fully aware of his frequent and repetitive abductions to UFOs. Here is how he describes a small pyramid, which he observed in operation, took to his hands, and even examined visually:

"I asked my host {an UFOonaut} in what manner they satisfy their energy requirements. For the answer, he demonstrated to me a device, which he described as their standard energy supply equipment. (Supposedly they equip with such a device every alien sent to Earth to mix with people in order to "study" our civilization.) The device had a shape of a small pyramid. It had a square base with the side dimension of around 550 mm, and it also had the same height of around 550 mm. It was made of a material looking like a plate of around 7 mm thick, whose composition resembled of our laminates. The pyramid weighted around 3 kilograms. The host {a UFOonaut} took it to hands and demonstrated to me that the bottom floor in it can be easily detached. After the floor was removed, the pyramid shown the interior, and with a surprise I noticed that it was completely empty inside. It was shiny on the outside, whereas inside it was covered with a kind of gold foil. Its surfaces looked as if covered with plexiglas, but when held in hands these surfaces felt (both inside and outside) like made of glass. According to the information of the host, the pyramid shown to me produced 2 KW of AC electric power at 230 Volts, 50 Hz. It operated only after the bottom plate was put on its place. The electric power that it produced was supplied to an ordinary plug normally used in human houses for plugging electrical appliances. This plug was mounted on the centre of one of its four side walls. My host actually demonstrated to me the operation of this pyramid through plugging to it an ordinary vacuum cleaner used on Earth currently. I checked the operation of this vacuum cleaner by switching it on and switching it off, and also by using it on the floor of the UFO vehicle. It worked perfectly, showing a powerful suction, while it was supplied with electricity only from this moveable and empty inside pyramid. The operation and output of this pyramid did not seem to be dependable on the position or orientation in which the pyramid was situated. My UFOonaut recommended, that Earth's scientists should concentrate on the development of such a device, as it would relieve our planet from currently prevailing plagues, such as pollution, over-exploitation of natural resources, etc. At the same time the research on this device would lift our science at much higher level of awareness. However, he warned, there is going to be a lot of opposition against introduction of such devices, because the energy that they produce is for free and cannot be taxed. In turn taxes are the foundation of almost every political regime that currently controls human societies."

The possibility of building of telekinetic batteries that would supply our civilisation with free energy, surfaces from a significant number of discussions with UFOonauts. Other example of an unambiguous promotion of this pyramid is contained on page 75 of a book [1T4] by Timothy Good, "Alien Liaison", Arrow Books Limited (20 Vauxhall Bridge Road, London SW1V 2SA), 1992, ISBN 0-09-985920-3. This book quotes an UFOonaut, who to the shocked expert of paediatrics and anaesthesia from the hospital named "Hospital del Ferrocarril del Pacifico in Guadalajara" in Mexico explained as follows:

"It is necessary for you to find another energy source, and it is very easy. For that which you call electricity is an eternal energy ... it is free. It is possible to get tremendous energy if you know how to dissociate electrons, for in this way you can have the free energy you need, without contamination or pollution, and this is what we use to travel space ...").

Re. #2. **TRI of the second generation.** These include computer interfaces that recognise thoughts, feelings, and experiences. They are even more advanced technical

devices than telekinetic batteries. They require extremely advanced level of technology. These TRI of the second generation are described in subsection N3.2. After analysing various reports from abductions of people to UFOs, it turns out that these devices are used in UFOs very frequently, in almost all applications described in items 1 to 6 from subsection N3.2. Practically almost every person aware of his/her abductions to UFOs, has an opportunity to experience the operation of these devices on him/herself. Only that usually he/she has no idea from what device these experiences originate. Amongst many applications and variants, for which TRI of the second generation can be used, and which are presented in items 2 to 6 of subsection N3.2, people most frequently experience on themselves their operation as **"generators of feelings and experiences"**. In such application TRI of the second generation usually are utilised for inducing in scared UFO abductees feelings of trust, peace, and pleasure, which allow to subject them to undisturbed exploitation and examination, which usually are very painful. After inducing these feelings, UFO abductees usually are not so scared, and begin to cooperate with UFOonauts for accomplishing goals of given abductions. (Examples of such situations are presented in paragraphs N-30 and N-52 of Appendix A from monograph [2e].)

Another application of these devices, also utilised frequently in UFOs, is their use as **"modifiers of appearance"**. This use is described in item 5 from subsection N3.2. It should be emphasized here that UFOonauts very frequently assume an appearance, in which they feel more acceptable for people. They utilize for this purpose the capabilities of TRI of the second generation that they have in their vehicles. These TRI produce in human minds the required pictures of UFOonauts. One of the more interesting cases of such assuming by an UFOonaut the appearance of a person that was well known to a given UFO abductee, is described on pages 202 to 203 of the book [1T1]. This case reports on experiences of someone called Sara, who went to skiing expedition alone, i.e. without her friend Miguel. However, at night in the hotel appeared an UFOonaut, which initially was looking exactly like Miguel. Then it turned out that this UFOonaut really looks like a lizard or a snake. The similarity to the friend of Sara named Miguel, this UFOonaut assumed only temporary in order to break the barrier of strangeness or an initial disgust. Here is the exact quotation of the most relevant parts of this quite long description:

"Miguel had not gone on the ski trip with Sara, but 'the minute I bumped the corridor Miguel was in the room' ... It was as if 'a being that looked like Miguel' or 'a disguise of Miguel' came through. ... The head was the most prominent part of the body and was 'shimmery', looking 'reptilian', almost 'snakelike, serpentlike' and quite elongated. 'Red vein-things' made the head appear like 'a body turned inside out'. ... It was 'sweet', she said for the being to 'put on' the Miguel costume in order to bridge the gap of unfamiliarity."

One of the most vital lessons that result from the above description is, that most probably in the history of our contacts with UFOs, both UFOonauts and their vehicles frequently show themselves to people only after firstly adopting the appearance that was the most acceptable to people of a given historic epoch. From the above originates the excellent explanation why in the antiquity and medieval times UFOs were always seen as "planets" and "comets", near the end of last century UFOs show themselves to people as "airships", while in 50s of 20th century the same vehicles were frequently noted as "ghost rockets". The true, discoidal shape of UFOs was established only since relatively recent, namely since around beginnings of 1950s.

The ability to assume any appearance, identical to the one that present UFOonauts have, displayed also various supernatural beings that are described by legends and mythology of various nations. The most known examples of such creatures that are known in almost every culture, are devils capable of an instant change of appearance. Devils can become similar to any person. Also gods from Greek and Roman mythology have the same ability. For example, Hercules (Heracles) was beget by Zeus just when this god assumed the appearance of Amphitryon, the husband of beautiful Alcmene from Thebes. A moment after the departure of Zeus, Amphitryon returned from the expedition and again took beautiful Alcmene in his

arms. In this way twins were beget, in which the giant Hercules was the son of god Zeus, who took the appearance of Amphitryon for the duration of the intercourse, and the earth woman Alcmena. In turn a normal size Iphicles was the son of human Amphitryon and his wife Alcmena - for details see under the term "Hercules" in [2T4] "New Larousse Encyclopedia of Mythology", Paris 1968, ISBN 0-600-02351-6, page 169. In subsection JE9.3 the reason is explained, for which the powerful telekinetic field that prevailed during the intercourse between the UFO-naut Zeus and the earth female Alcmena, caused Hercules to grow up to such a gigantic size.

The understanding of capabilities created by "modifiers of appearance" realises, that the appearance of UFO-nauts or UFOs described by eye witnesses, not necessarily must be a real one. So a case of our meeting of a person, or an object, that is well known to us, not necessarily means that it is NOT a UFO-nauts or a UFO. It is also worth to notice, that a temporary assuming of an appearance of someone that we know quite well, is just only the first one amongst many possibilities utilised by UFO-nauts for hiding their presence with the use of "modifiers of appearance". Further such possibilities depend on adopting by UFO-nauts an appearance of any other object. Several examples of such changes of appearance of UFO-nauts is described in an article [3T4] by Budd Hopkins, entitled "Wziewcia a iluzje" (i.e. "Abductions and illusions") that was published in the Polish quarterly UFO number 2(30), April-June 1997, pages 36 to 42. On page 38 of this article a case of a known American UFO abductee, Virginia Horton, researched by Budd Hopkins, is described. She met in the forest and talked to an ordinary white deer, which later turned out to be an apparent shape temporarily created by the personal "modifier of the appearance" of an UFO-naut. As a main case of the article [3T4], Budd Hopkins describes the abduction of a student of University of Washington, who appears under the pseudonyme "Kerry". This abduction took place in January 1988 and was carried out into a cigar-shaped UFO composed of six UFO vehicles placed one on the top of other. For outside observers these UFO vehicles also modified their appearance assuming the shape of a pile of damaged cars. On pages 36 and 37, Hopkins write, quote in my translation from Polish: "In a moment later they arrived to a road crossing, in the centre of which one upon the other six cars were lying. ... Creatures took Kerry to the UFO, which only a moment earlier looked like a pile of damaged and deserted cars. After a typical examination, which usually takes place during UFO abductions, she was put to {her own} car and told, that all that she saw she will remember as an accident involving six cars." As we see, there is also a documented case of a cigar-shaped UFO coupled from six vehicles, that assumed the shape of a pile of damaged cars with the use of a "modifier of appearance". In Poland I met a case of a UFO eye witness in 1981, who was shocked by a change of this mechanical vehicle into an alive doe. It seems that deer and doe, are favourite pictures created by modifiers of appearance of UFO-nauts. An old legend from India states that one of their goddesses appeared in the form of a cow - surely also due to the use of her personal modifier of appearance. (Probably this is where the idea of "holy cows" comes from.) I also read about cases, when UFO-nauts appeared after they modified their appearance to forms of motorcycles, intelligent dinosaurs, a large owl, and a large banana.

Our possible learning to distinguish in which moment of time the appearance of UFO-nauts is generated by their "modifiers of appearance", while in which it is a real one, has a very vital significance to the security of our civilisation. In the future it may allow us to qualify in a fast and conclusive manner the category to which given aliens belong. (Means to a category of invisible occupants of Earth, or our cosmic allies.)

Another very frequent use of TRI of the second generation in UFOs, is the application of it as a "**reproducer of experiences**". This device is described in item 2 from subsection N3.2. This reproducer is used on people mainly for accomplishing the "**affiliation**" of a person abducted to a UFO, with UFO-nauts. (The process of "affiliation" is described in more details in subsection I5.7.) In this way people abducted to UFOs become convinced that they themselves were, or still are, UFO-nauts. So in case of recalling or reporting a course of their

abductions, this introduces even a larger confusion amongst listeners, decreases the belief of people in the reality and physical character of UFO abductions, and adds arguments and ammunition to "sceptics" telepathically manipulated by UFOonauts to attack researchers of this phenomenon. In the final effect, this increases the chance of UFOonauts for extending the time of unnoticed exploitation of Earth. Other benefit, for the accomplishment of which the "affiliation" is mainly carried out by UFOonauts, is the **dumping of unwanted karma to people**. If an UFOonaut with whom a given human is affiliated, commits any crime, e.g. rapes someone, the karma for this crime is to charge not this UFOonaut, but a human that is affiliated with him - for details see subsection I5.7. One of the descriptions of just such a use of the "reproducers of experience", which has a multilevel connection with the main thesis of this monograph presented in subsection AB1, is contained on pages 174 and 176 of the book [1T1]. In this description, the mind of a UFO abductee named Joe, was affiliated with the mind of an UFOonaut called Orion. In the description below, this affiliation of both minds is described with the use of term "identity". Simultaneously Orion surely assumed the exact appearance of Joe through the use of the device in subsection N3.2 called the "modifier of appearance". In the effect of this affiliation of both minds, in the Joe's mind reproduced were all experiences through which Orion went during the presence of Joe's on his spaceship. Simultaneously the karma for the immoral activities of Orion, charged the register of the human named Joe, not the actual alien doer of these immoral acts. One of these experiences was the subjecting of human women named Adriana to something that in our courts would be called a "rape", and for which the human Joe must pay back the karma by being raped himself in the future. Here is the relevant quotation from the book [1T1]:

"His {Joe's} own form kept changing, 'like a chameleon'. He felt 'more comfortable in a shape like them' ... Joe called the race of being to which he belonged in his humanoid identity the 'brotherhood'... I feel like my thoughts are available to everyone, and there's nothing to hide. There's no shame... Joe told then of an experience he had just a few days earlier as 'Orion', his humanoid identity. ... A blond woman of about thirty-five he called 'Adriana' was brought to him so that he could 'make love with her' and 'give her my seed'. ... Adriana was walking her dog at night when she was abducted and was 'in a sleepy state' when the beings floated her into the ship. 'Part of her freaked out when she first saw the ship', Joe said. He felt loving and gentle toward Adriana, stroked her head, reassured her that 'we care for you' and encouraged her to relax. 'I wouldn't copulate with her without on some level her cooperation, her agreement.' ... Adriana was placed on a slightly tipped platform with her head higher than her feet. She was kept in a sleepy or dreamy state ('mentally they create, like, this web ... they just drape her in this soft, gentle energy')... The sexual or reproductive act itself was quite brief. Three or four of the beings watched as Orion inserted his small 'almost hollow' penis into Adriana's vagina. ... 'It's not a rhythmical in and out intercourse. It feels more like just a rocking embrace... I can just put it in and release it'. A clear fluid 'just oozes out'. Although Joe or Orion caressed Adriana lovingly, she appeared to be split. Part of her 'is totally present' and 'the interaction feels beautiful,' but her 'stormy' fearful part felt violated."

Although the original description of the above case did not check what actually Adriana did see, on the basis of my research to-date I am sure, that if one asks her who was the rapist, her reply would be that a human Joe, not an UFOonaut Orion. Such reply in turn would mean the confirmation of the thesis of subsections I4.4 and I5.7. This thesis states, that due to assuming of the appearance of specific humans, UFOonauts dump the karma for their rapes into selected humans. In this case onto Joe. Furthermore, that UFOonauts carry out their rapes with the use of a modifier of appearance. At such a technique of UFOonauts' rapes point stories of many human females abducted to UFOs, which report that they were raped in there by a "human", although the entire rape was watched by many UFOonauts. What is difficult to understand in these reports, is the fact of a public rape by a "human". We all know that the culture on Earth is such, that sexual intercourses are carried out in privacy. All males, who reported carrying out a sexual intercourse on a UFO deck, always had this intercourse without

witnesses noticed by themselves. Means that their cultural custom of intimacy and privacy during an intercourse was respected in there. In turn UFOonauts seem to have a cultural custom to carry out public intercourses, similarly like ancient Romans did this. All known to me intercourses, which were done by UFOonauts, always had a public character with at least one witness watching. The above suggests, that if an Earth women reports that was raped on a UFO deck by a "human" but in a public manner, there is a strong premises to suspect, that in reality she was raped by an UFOonaut. Only that with the use of a "modifier of appearance" this UFOonaut affiliated himself to some nad've human male, in order to dump on this male the karma for a given rape.

At this point it is worth to emphasize, that the above case explains why in present days so large number of people have aware or intuitive conviction, that they themselves used to be UFOonauts. Only that later they arrived to our planet in UFO vehicles. Furthermore, it explains why the phenomenon of UFO abductions is surrounded on Earth by such a dense confusion and a lack of understanding. It also explains why so many our women abducted to UFOs reports that they were raped by some Earthly "human male". (As I am explaining this here, they actually were raped by an UFOonaut, only that he took an appearance of an Earthly man who was to accept the karma for a given rape.) Furthermore, it explains why people who accept the seriousness of UFO abductions, declare at the same time that these abductions take only place in minds of subsequent victims. Means they declare, that these rapes are not physical. This fragment reveals also a huge difference between UFO civilisation and our one. After all, in UFO civilisation thoughts and feelings of every single member are known by all others. So does not exist such a thing as a shame or a need for "privacy". Sexual intercourses are carried out in it in a public manner, etc. This illustrates also a bitter reality of UFO abductions, giving a taste of moral suffering and humiliation through which victims of these abductions must go. These suffering, after the return of victims to Earth, are still magnified by people, who attack and scoff the unfortunate victims. Furthermore, on an example of Adriana, this case reveals also a course of a "typical" unaware UFO abduction. In such an abduction, a victim is taken during some sort of a banal activity, such as taking a dog for a walk in evening. Then the victim is hypnotically put to sleep, raped, and publicly humiliated on a UFO deck. Finally, after her memory is erased and her time shifter backward, she is send to Earth to the point of abduction. In this way she continues her activities, e.g. taking her dog for a walk, without having an aware knowledge, what actually has happened to her. Her experiences are going to return to her mainly in a non-material form. For example they transform into night mares, phobias, allergies, unaware feelings, disgusts, hold ups, sexual coldness, nervosas, untypical reactions and behaviours, etc. - for details see chapter U. Usually these are treated by her surrounding as kinds of imaginary problems. Finally this case also reveals how probable is the thesis from item #5 of subsection P3.3, about decision makers on Earth being constantly manipulated by UFOonauts, so that they ignore the UFO subject area. After all, cases of such open endangering security of humans, as the one described above, should cause an immediate reaction of appropriate authorities. (Imagine what would be a reaction of authorities if there is a human rapist on streets, who does similar things to human women that UFOonauts continually do!) These authorities should initiate detailed research directed at the explanation of role and intentions of UFOonauts. But it turns out that such cases are either completely ignored, or intentionally silenced. In turn researchers who try to point attention at them are attacked - for details see a commentary after [1T1]. This in turn indicates clearly, that the decision makers on which these actions depend, in unaware manner support interests of UFOonauts, not interests of their own citizens.

In order to complement the above descriptions of a rape, I would like to also mention, that in 1992 I researched in New Zealand a case of an aware UFO abductee, to which I am going to refer here with the use of pseudonyme "Jenny". She gave me a report from a rape by a UFOonaut, to which she was subjected several years earlier, when she lived with parents in a house sheltered by trees, distant by around 100 meters from a golf course. One night when she

was alone in the house, she noticed through the window a spaceship that landed behind trees. Already at the moment of noticing this spaceship she intuitively felt, that it arrived to her. So she froze with fear. A moment later through a wall two aliens in glowing suits slipped into her bedroom, a male and a female. For a moment they observed her, vividly discussing something amongst themselves. Then the male raped Jenny in a full awareness of her senses and without any hypnotic putting her into a sleep. During the rape women watched this with the body language of an expert, and without signs of any emotional involvement. Components of her rape that coincided with the previous descriptions of the rape of Adriana, were that: (1) the rape had a public character, with a female UFO naut watching it carefully from the beginning to end, (2) Jenny reported that the penis of an UFO naut that penetrated her also felt as if it is a cold plastic pipe almost empty inside, (3) this UFO naut also did not make rhythmical motion in and out as this is done by humans during a sexual intercourse. (Jenny reported, that after slipping his penis inside of her, he simply hold her almost without any movement, while in her the feeling of sexual excitement started to gradually grow, most probably induced by his personal TRI. In the final stage this excitement transformed into an orgasm.) At my question whether after this rape her monthly cycle was disturbed, Jenny took a notebook in which she wrote dates of all her periods starting from the moment of their first appearance. In this notebook was recorded, that for two months after that particular rape, her monthly cycle disappeared completely, then it appeared again. I suspect that in the result of this intercourse, Jenny got pregnant. In turn her fetus was removed from her and shifter to an incubator on a UFO vehicle during a next, this time unaware, UFO abduction that took place around two months later. Although I do not have the expertise required, in order to estimate the psychological consequences of this rape, Jenny herself was admitting, that it exerted a very undesirable influence at her sexual life. After giving this report, she also helped me to inspect the golf course near her former house. And in fact on this golf course I found numerous biologically active rings of more dark and more fast growing vegetation. According to my research such rings represent landing sites of UFO of the second or third generation. Other finding reported by Jenny was that during the period close to the date of this rape she noticed several night bleedings from her nose. Namely in mornings she kept finding one or several droplets of blood on her pillow. She intuitively linked them to the UFO. The above should be also complemented with the information, that amongst women who remember systematic abductions to a UFO, there are cases when these women display inclinations to accomplish an orgasm only if in the last phase of intercourse their male partner behaves like a UFO naut. Means he either does not move at all, or moves very slowly. Although this may be just a "coincidence", we should not exclude the possibility that these inclinations are from a hypnotic program that was left in their subconsciousness after sexual behaviours of UFO nauts.

I am also aware of several cases, when human males were treated in a manner very similar to that described above. Although in our culture the use of the expression "rape" is not linked to the sexual exploitation of a male against his will, in psychological sense the consequences of such a treatment can be similarly devastating as this is the case with rapes of women.

Re. #3. Demonstration Chambers. These represent the most advanced application of TRI of the second generation. Their description is presented in item 1 from subsection N3.2. Such a chamber is located practically in every larger UFO vehicle. By subsequent UFO abductees they are named in different ways, sometimes as "recreation room", other time as "cinema room", or "conference room". A brief report from visit in just such a chamber, together with the description of feelings that were experienced in there, is provided in Appendix A of monograph [2e] - see there the second half of paragraph N-98. Depending on the situation, in this chamber is carried out either teaching, or demonstration of various situations - for example the feeling of a personal participation in a military battle or the appearance of Earth after a possible nuclear war, or carrying out important discussions. Here is how the appearance and operation of such a "demonstration chamber" is described by several different UFO abductees,

namely by Jerry, Peter, Catherine, and Ed, in the mentioned earlier book [1T1]:

- Page 107: "In one of three episodes in 1991, Jerry reports being taken by taller, more human-looking, fair-skinned, blond beings to what seemed like the top of a very large building with illuminated equipment in it. She had the sense that she was at a beach or a seashore, as she heard the wind and the water breaking, felt a breeze, and smelled the sea. High up in this building, Jerry was shown scenes of missiles and other weapons. She felt this was very important."

It is worth to notice that the above report describes also indirectly the appearance and equipment of the "demonstration chamber". Namely it is on the "top of building with illuminated equipment". Furthermore, it describes the interaction of this chamber with the hearing, touch, smell, and even feelings - e.g. see the final feeling of importance.

- Page 317. "Peter said, as he reexperienced being led down a hallway where 'they're gonna show me things'. ... He saw nuclear explosions, section of Europe and the United States destroyed, 'a lot of people burned, a lot of people upset ... the human race changing', its 'form' and 'texture'."

This quotation also refers to "demonstration chamber" from a UFO deck, describing this chamber as a huge room in which in a lying position one experiences various adventures and pictures.

- Pages 160-163. "They came to another room with a sliding door that slid open upwards. The room seemed to transform from a typically spare spaceship room with tables, curved walls, and perhaps a viewing screen into an ornate executive conference room complete with shag carpeting, mahogany panelling, and a large viewing screen. As Catherine described when she reviewed the tape of this session, she had had the impression that 'the more I thought of a corporate executive conference room, the more it appeared', but when she realized that this was a kind of staging, the conference room 'images just melted away to reveal the previous images, and finally the actual room'. During the session she said she was aware of the simulation of a conference room and objected to their concocting this just for her benefit. But she was told, 'We have to have a conference, so you have to think it's a conference, so we're taking you to a conference room so you can be in that kind of serious frame of mind'... Once she was through the staging theatricals, the room was returned to its original state and Catherine was told to sit on a small, cold metal chair. She was then shown scenes of nature on the screen, 'like a camera panning a forest - trees, and there's a deer, and you know, moss and dirt and needles on the ground, and I'm getting this impression like this is so beautiful, this is so beautiful'."

The above quotation is one of the best illustrations of capabilities of the "demonstration chambers", because it illustrates the ability of control devices of this chamber to read the content of current thoughts and memories of the user. More strictly, this device reads the content of registers of the user stored in the counter-world - compare descriptions from subsections I5.2 and I5.4. Then this device makes similar pictures that it displays to patterns already contained in these thoughts and memory. The quotation also reveals the perfection of this chamber in inducing the required effects in a user, through the synchronisation of pictures and emotional experiences being passed to the user with the user's current thoughts. Of course, not knowing about this Catherine did not see at all the true appearance of the demonstration chamber, but only a simulated by this chamber appearance of a typical cabin in a UFO. The real appearance of this chamber is known to us due to the report from another person recalling his UFO abduction, named Ed. He describes it in the following manner:

- Page 46. "He was in 'the pod with translucent walls' ... The female entity 'wants to talk to me' ... A seriousness comes over me. ... Ed felt that the inside of his head and his eyes were 'burning and spinning' as she began to talk to him and he was shown different things."

The above quotation describes the real shape and appearance of the "demonstration chamber". Compare this report with the content of item 1 in subsection N3.2. Again it confirms, that in this chamber not only pictures and sensory sensations are shown, but also feelings, e.g.

of seriousness. One of the vital information reported by Ed is the confirmation that in such demonstration chamber pictures and feelings are induced through a direct interaction with nerves of eyes and other senses. This in turn caused in Ed the 'burning and spinning' of eyes and head.

Re. #4. **Telekinetic tractor beam.** There is also a significant number of observations gathered so far, which describe in details the "beaming up" of people to UFO decks. As this is described in subsections L6 and M6, devices that do such a "beaming up" require the use of telekinetic tractor beam, which belongs to the technology of the second generation. This means that such a tractor beam utilises the Telekinetic Effect in the operation. One of the consequences of such "beaming up" is that people subjected to it are experiencing a significant loss of heat. This manifests itself through the feeling of cold, cold shivers, rattling teeth, etc. (For an example see Appendix A in monograph [2e], paragraph N-46.) Therefore the phenomenon utilised by UFO-nauts for carrying out this "beaming up" corresponds exactly to the attributes of the "telekinetic tractor beam" described in subsections L6 and H6.2.1. On the other hand, all effects and feelings that accompany such telekinetic shifting to a UFO deck, correspond exactly to the use of advanced propulsion systems based on a technical version of the Telekinetic Effect. These effects include e.g. the emission of a powerful "extraction glow", "paranormal experiences", passing through solid objects, the feeling of disintegration of the material structure of the body and conversion of this body into an energy pattern - for details see subsection L2, etc. The above confirms conclusively, that transportation devices that utilise the telekinetic tractor beam, are also utilised on UFOs by various technically advanced civilisations of evil UFO-nauts.

If one thoroughly analyses the descriptions of such "beaming up", then in every aspect they correspond to the predicted operation of telekinetic devices described in subsections H6.2.1 and L6. Let us now provide several quotations from the previously referred book [1T1], which document this fact:

Page 375. "I asked Arthur what was holding him in the air and he said it was 'the thread', which he estimated to be perhaps an eighth of an inch in diameter, 'like a kite string, maybe ... It connects me, but I don't know how it connects to me'. Although 'I could break it if I wanted to', he felt the beings pulling him upwards on the thread, lifting him 'into the room' as if on 'a rope or something'. The thread was like an arc, or half an arch."

Page 349. "{Karlos} felt a vibratory tingling sensation in his body and then the sense that my body is dissolved or diffused into its transparency ... The body just dissolves and goes up."

T5. Summary

The evidence provided in this chapter reveals conclusively that some UFO-nauts that exploit our planet already use Telekinetic Vehicles and Time Vehicles. In turn attributes of these vehicles and various devices utilised on them, can be predicted with a high accuracy by the means of the scientific theory called the Concept of Dipolar Gravity.

A technical analysis of experiences reported by various people abducted to UFOs, reveals also that UFO-nauts have in their disposal technical devices the range of applications, principles of operation, and induced effects of which lie far beyond the reach of not only our present knowledge, but even imagination of the majority of present orthodox scientists on Earth. For example, according to my findings, UFO-nauts already use technical devices that make them invisible on several different principles (described in subsections N3.2, N3.3, F10.3, L2, and M1), while Earthly orthodox scientists so-far were unable to theoretically explain even a single one of them. Therefore it is extremely vital that these scientists stop the to-date negations, criticising, and scoffing UFO phenomena, and start constructive research. An entire ocean of completely new knowledge awaits for the discovery and practical utilisation. In turn

devices which can be constructed in the effect of such research, perhaps one day save mothers, sisters, wives, and daughters of these orthodox scientists, and also these scientists themselves, from suffering, humiliation, and disgrace that they experience currently during UFO abductions.

One of the important facts that constantly stems from descriptions of this chapter, is that UFO-nauts not only utilise their huge technological advantage for arriving to Earth and for accomplishing parasitic goals for which they arrived here, but they also utilise it for continuous hiding their presence on our planet - so that their activities remain unnoticed by us. On pages 414 and 415 of the book [1T1] referred before, a description is contained which confirms that UFO-nauts have and consequently implement the policy of not creating any occasion which would realise to people their continuous presence on our planet. Here is this fragment, quote:

"Anne describes an amusing incident that occurred at the end of one of her abductions in which an alien being seemed unwittingly to betray his affection to her. She had been returned to her bed at home and was, presumably, asleep. But she awoke to see one of the beings 'looking at me with a loving look ... just looking at my face, looking at my features ... looking at my eyes, looking at them with such emotion, such love ... When he found out I was awake', she said, 'he freaked out ... His eyes [crinkled], they [got] smaller. I think his mouth did open,' ... When she looked into his eyes the expression was one of 'Oh, my God, you're awake and I'm in a shitload of trouble', and 'then he went whoosh out the window ... floating horizontal, like lengthwise ... I think he was like a doctor-in-training,' Anne observed, and 'he wasn't supposed to take it personally ... an alien would be in trouble for waking somebody up because they don't want us to know that they're around'."

One of the primary truths of life, which our civilisation realised during the developments to date, states that: **"if someone tries to hide from us, this always means that such someone has something very dirty for hiding"**. (This truth is expressed, amongst others, in the English proverb "Wherever there is a secret, there must be something wrong".) Since the evidence presented in this chapter clearly confirms that UFO-nauts have and utilise technical devices which allow them to hide from people the fact of their continuous occupation of Earth, for our own good we better start to watch their hands. Even if later could turn out that their intentions were positive, still an English proverb states that "It is better to be cautious than to be sorry".



Fig. T1. Telekinetic UFOs. This photograph (originally in colour) shows two UFOs type K7 coupled together into a detached configuration. (The formation of such arrangement is explained in Figure F10, whereas other example of a detached configuration, only that coupled from two UFOs operating in the magnetic convention, is shown in Figure S1.) It was published in the Journal "The Unexplained. Mysteries of Mind, Space & Time", Volume 1, Issue 1, 1980, page 4. In high quality copies of this photograph the vehicles look as if they are "oiled with white light", thus confirming their emission of the extraction glow. Moreover, the same configuration is simultaneously captured in two different positions. This in turn indicates that the photograph registered two subsequent pulses of the telekinetic state (see explanations from subsection L2), i.e. a state distinctive to the telekinetic convention. Thus the photographed vehicles must represent UFOs flying in the telekinetic convention which is characteristic only to UFOs of the second or third generation.

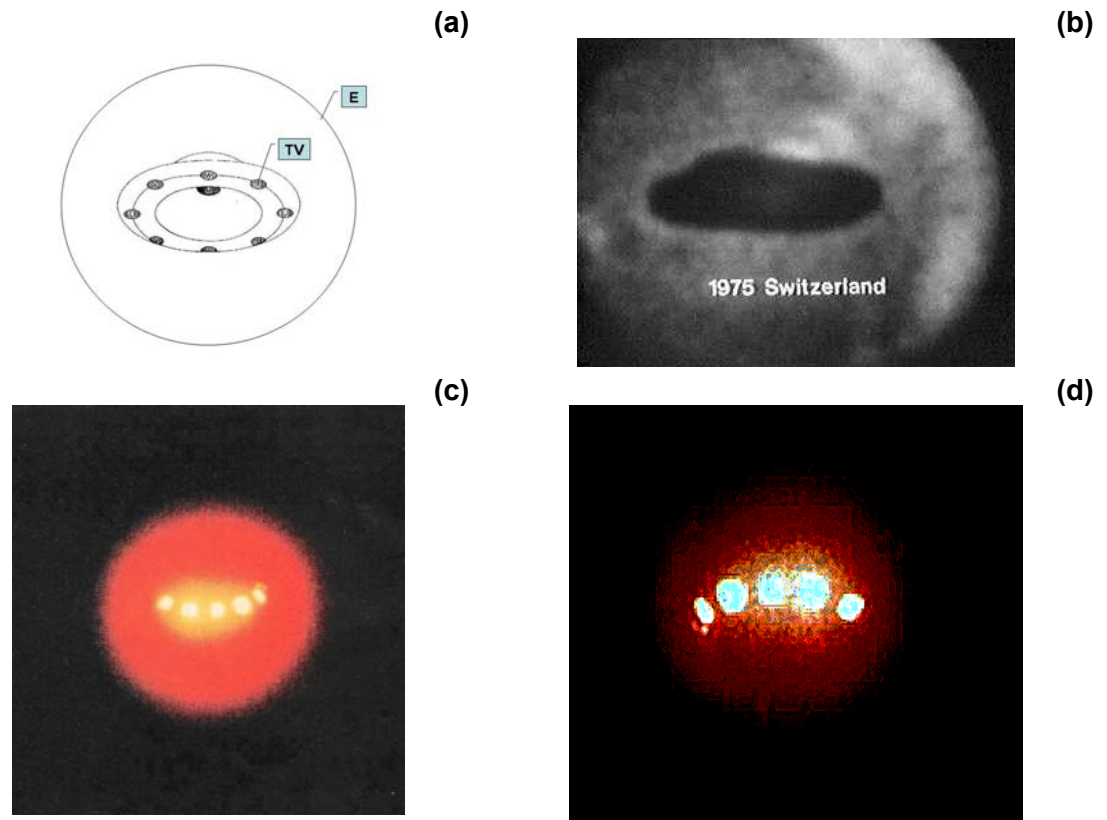

Fig. T2: Illustration of the appearance of time vehicles at the moment when they carry out a jump to another point in time. Such time vehicles for already operate on the Earth, only that people call them UFOs. Photographs (b) to (d) show just such UFOs operating as time vehicles. On photographs of these vehicles clearly visible is a sphere of space excited to glow by energy of vibrations of magnetic field of these UFOs. In the centre of this sphere visible are outlines of discoidal UFOs with glowing outlets from Oscillatory Chambers assembled in propulsors of these vehicles.

a (top-left): A drawing which explains what actually becomes visible on photographs of time vehicles. As this drawing illustrates, photos of time vehicles typically capture round sphere of space excited to glow by the energy of vibrations of magnetic field of this vehicle. This sphere is marked with the symbol "E" (from English "Energy"). This energy spreads uniformly in all directions from the main propulsor of a given time vehicle, behaving similarly like thermal energy (after all, heat is also a kind of vibrations). The time vehicle itself marked with the symbol "TV" (from English "Time Vehicle") hovers as if hidden inside of this sphere of glowing space. The drawing shows it in the standing position. Because of the low transparency of the sphere, usually most clearly in this time vehicle are visible outlets from Oscillatory Chambers of its propulsors.

b (top-right) Black-and-white photograph of time vehicle which flies in the standing position (i.e. with its floor directed down, while main propulsor – directed up). The unique for this photograph is, that apart from the sphere excited to glow by the energy of vibrations of magnetic field, the photograph captured also the relatively clear outlines of discoidal UFO hovering in the centre of this sphere.

c (down-left): A photograph of a UFO of third generation which flies in a hanging position (i.e. when the main propulsor is pointed down, while floor is pointed up) and in so-called "convention of time travel". It clearly shows the sphere of space induced to glow by powerful vibrations of the magnetic field of this vehicle, with glowing white outlets of side propulsors of this vehicle. This spherical excited ("deformed") space distinguishes the appearance of UFOs which fly as time vehicles, from telekinetic and purely magnetic UFOs. In order to learn and notice these differences in the appearance, it is worth to have also a look at web pages [immortality.htm](#) (about principles of extending lives through repetitive shifting back in time to years of our youth), [explain.htm](#) (about scientific interpretation of authentic photographs of UFOs) and [ufo_proof.htm](#) (about formal scientific proofs for the existence of UFOs) These web pages show the appearance of UFOs flying in all three conventions, namely (1) magnetic, (2) telekinetic, and (3) time vehicles. Photographs of UFOs flying in all these conventions are also included to PDF versions of the Polish treatise [4c] (see subsection C9 in there), and monograph [1/5] (see subsection N3.1).

d (down-right): Another photograph of a UFO that flies in the standing position and works as a time vehicle. Again is visible this unique sphere of glowing space excited by energy of vibrations of the magnetic field of this vehicle, together with white glows of outlets from side propulsors of this space vehicle.