

## 54LS05/DM54LS05/DM74LS05 Hex Inverters with Open-Collector Outputs

### General Description

This device contains six independent gates each of which performs the logic INVERT function. The open-collector outputs require external pull-up resistors for proper logical operation.

### Features

- Alternate Military/Aerospace device (54LS05) is available. Contact a National Semiconductor Sales Office/Distributor for specifications.

### Pull-Up Resistor Equations

$$R_{MAX} = \frac{V_{CC} (Min) - V_{OH}}{N_1 (I_{OH}) + N_2 (I_{IH})}$$

$$R_{MIN} = \frac{V_{CC} (Max) - V_{OL}}{I_{OL} - N_3 (I_{IL})}$$

Where:  $N_1 (I_{OH})$  = total maximum output high current for all outputs tied to pull-up resistor

$N_2 (I_{IH})$  = total maximum input high current for all inputs tied to pull-up resistor

$N_3 (I_{IL})$  = total maximum input low current for all inputs tied to pull-up resistor

### Connection Diagram

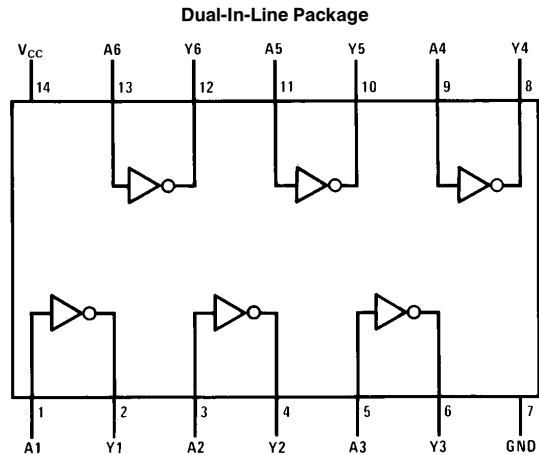

TL/F/6346-1

Order Number 54LS05DMQB, 54LS05FMQB, DM54LS05J, DM54LS05W, DM74LS05M or DM74LS05N  
See NS Package Number E20A, J14A, M14A, N14A or W14B

### Function Table

$$Y = \bar{A}$$

Input	Output
A	Y
L	H
H	L

H = High Logic Level

L = Low Logic Level

## Absolute Maximum Ratings (Note)

If Military/Aerospace specified devices are required, please contact the National Semiconductor Sales Office/Distributors for availability and specifications.

Supply Voltage	7V
Input Voltage	7V
Output Voltage	7V
Operating Free Air Temperature Range	
DM54LS and 54LS	−55°C to +125°C
DM74LS	0°C to +70°C
Storage Temperature Range	−65°C to +150°C

Note: The “Absolute Maximum Ratings” are those values beyond which the safety of the device cannot be guaranteed. The device should not be operated at these limits. The parametric values defined in the “Electrical Characteristics” table are not guaranteed at the absolute maximum ratings. The “Recommended Operating Conditions” table will define the conditions for actual device operation.

## Recommended Operating Conditions

Symbol	Parameter	DM54LS05			DM74LS05			Units
		Min	Nom	Max	Min	Nom	Max	
V <sub>CC</sub>	Supply Voltage	4.5	5	5.5	4.75	5	5.25	V
V <sub>IH</sub>	High Level Input Voltage	2			2			V
V <sub>IL</sub>	Low Level Input Voltage			0.7			0.8	V
V <sub>OH</sub>	High Level Output Voltage			5.5			5.5	V
I <sub>OL</sub>	Low Level Output Current			4			8	mA
T <sub>A</sub>	Free Air Operating Temperature	−55		125	0		70	°C

## Electrical Characteristics over recommended operating free air temperature range (unless otherwise noted)

Symbol	Parameter	Conditions	Min	Typ (Note 1)	Max	Units
V <sub>I</sub>	Input Clamp Voltage	V <sub>CC</sub> = Min, I <sub>I</sub> = −18 mA			−1.5	V
I <sub>CEX</sub>	High Level Output Current	V <sub>CC</sub> = Min, V <sub>O</sub> = 5.5V V <sub>IL</sub> = Max			100	μA
V <sub>OL</sub>	Low Level Output Voltage	V <sub>CC</sub> = Min, I <sub>OL</sub> = Max	DM54	0.25	0.4	V
		V <sub>IH</sub> = Min	DM74	0.35	0.5	
		I <sub>OL</sub> = 4 mA, V <sub>CC</sub> = Min	DM74	0.25	0.4	
I <sub>I</sub>	Input Current @ Max Input Voltage	V <sub>CC</sub> = Max, V <sub>I</sub> = 7V			0.1	mA
I <sub>IH</sub>	High Level Input Current	V <sub>CC</sub> = Max, V <sub>I</sub> = 2.7V			20	μA
I <sub>IL</sub>	Low Level Input Current	V <sub>CC</sub> = Max, V <sub>I</sub> = 0.4V			−0.36	mA
I <sub>CCH</sub>	Supply Current with Outputs High	V <sub>CC</sub> = Max		1.2	2.4	mA
I <sub>CCL</sub>	Supply Current with Outputs Low	V <sub>CC</sub> = Max		3.6	6.6	mA

## Switching Characteristics at V<sub>CC</sub> = 5V and T<sub>A</sub> = 25°C (See Section 1 for Test Waveforms and Output Load)

Symbol	Parameter	R <sub>L</sub> = 2 kΩ				Units
		C <sub>L</sub> = 15 pF		C <sub>L</sub> = 50 pF		
		Min	Max	Min	Max	
t <sub>PLH</sub>	Propagation Delay Time Low to High Level Output	6	20	20	45	ns
t <sub>PHL</sub>	Propagation Delay Time High to Low Level Output	3	15	4	20	ns

Note 1: All typicals are at V<sub>CC</sub> = 5V, T<sub>A</sub> = 25°C.

**Physical Dimensions** inches (millimeters)

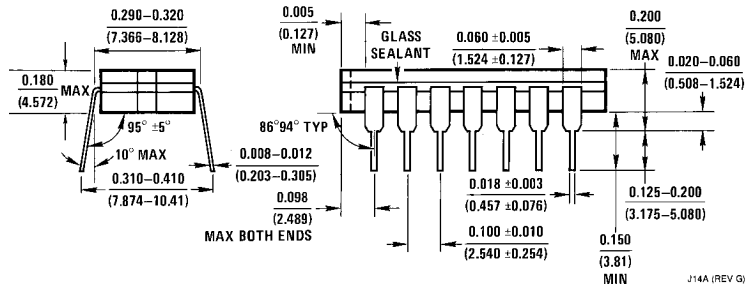
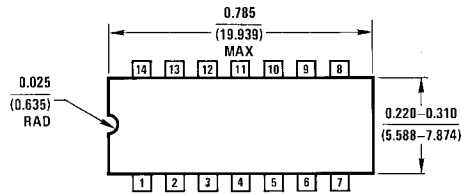

**14-Lead Ceramic Dual-In-Line Package (J)**  
**Order Number 54LS05DMQB or DM54LS05J**  
**NS Package Number J14A**

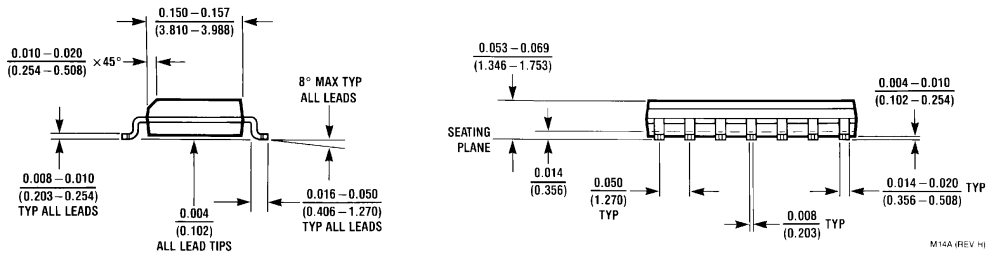
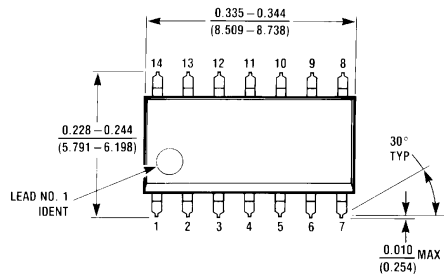

**14-Lead Small Outline Molded Package (M)**  
**Order Number DM74LS05M**  
**NS Package Number M14A**

**Physical Dimensions** inches (millimeters) (Continued)

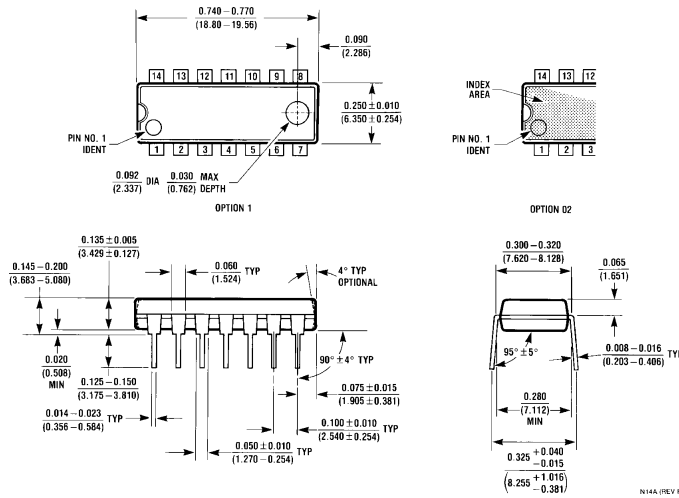

**14-Lead Molded Dual-In-Line Package (N)**  
**Order Number DM74LS05N**  
**NS Package Number N14A**

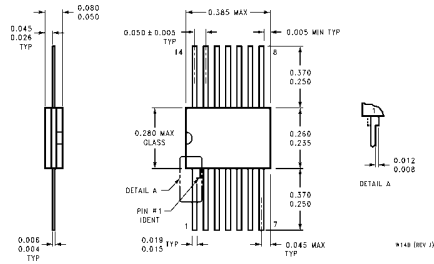

**14-Lead Ceramic Flat Package (W)**  
**Order Number 54LS05FMQB or DM54LS05W**  
**NS Package Number W14B**

**LIFE SUPPORT POLICY**

NATIONAL'S PRODUCTS ARE NOT AUTHORIZED FOR USE AS CRITICAL COMPONENTS IN LIFE SUPPORT DEVICES OR SYSTEMS WITHOUT THE EXPRESS WRITTEN APPROVAL OF THE PRESIDENT OF NATIONAL SEMICONDUCTOR CORPORATION. As used herein:

1. Life support devices or systems are devices or systems which, (a) are intended for surgical implant into the body, or (b) support or sustain life, and whose failure to perform, when properly used in accordance with instructions for use provided in the labeling, can be reasonably expected to result in a significant injury to the user.
2. A critical component is any component of a life support device or system whose failure to perform can be reasonably expected to cause the failure of the life support device or system, or to affect its safety or effectiveness.

 <p><b>National Semiconductor Corporation</b>          1111 West Bardin Road          Arlington, TX 76017          Tel: 1(800) 272-9959          Fax: 1(800) 737-7018</p>	<p><b>National Semiconductor Europe</b>          Fax: (+49) 0-180-530 85 86          Email: cnjwge@tevm2.nsc.com          Deutsch Tel: (+49) 0-180-530 85 85          English Tel: (+49) 0-180-532 78 32          Français Tel: (+49) 0-180-532 93 58          Italiano Tel: (+49) 0-180-534 16 80</p>	<p><b>National Semiconductor Hong Kong Ltd.</b>          19th Floor, Straight Block,          Ocean Centre, 5 Canton Rd.          Tsimshatsui, Kowloon          Hong Kong          Tel: (852) 2737-1600          Fax: (852) 2736-9960</p>	<p><b>National Semiconductor Japan Ltd.</b>          Tel: 81-043-299-2309          Fax: 81-043-299-2408</p>
--	--	---	---

National does not assume any responsibility for use of any circuitry described, no circuit patent licenses are implied and National reserves the right at any time without notice to change said circuitry and specifications.

This datasheet has been download from:

[www.datasheetcatalog.com](http://www.datasheetcatalog.com)

Datasheets for electronics components.