

1. HEATER

1.1. Low noise values

To obtain the minimum noise figure the heater voltage must be within $\pm 2.5\%$ of the specified value and temporary fluctuations must be within $\pm 5\%$.

1.2. Intermediate and power values

To obtain the maximum life the heater voltage must be within $\pm 2.5\%$ of the nominal value and temporary fluctuations must be within $\pm 10\%$.

2. COOLING

It may be necessary to provide additional cooling to prevent the valve and focusing system temperature limits being exceeded.

Forced cooling of the collector terminal may be required and recommendations will be given in the individual valve data.

Normally cooling of electromagnetic focusing systems will be required.

3. FOCUSING MOUNTS

A suitable magnetic field is provided by the mounts available from Mullard Limited.

Designers who do not propose to use one of these mounts should consult the valve manufacturer as an unsuitable mount can impair the performance of the valve. In many instances, the focusing mount incorporates the radio frequency input and output connections with suitable matching devices.

Focus alignment screws are provided on the approved mounts and a pre-setting procedure for these has been established (see appropriate data sheets). This procedure will reduce the risk of damage to the valve due to excessive helix dissipation during the focusing operations.

4. SHIELDING

Any disturbance of the focusing field may impair the performance of the valve, and the valve must be protected from the effects of nearby ferrous material and stray magnetic fields.

The degree of susceptibility to such interference varies for different focusing systems and specific information will be given in the individual data sheets. Unless magnetic shielding or component orientation is adopted ferrous objects should be kept more than 9 inches away and other magnetic objects should be positioned 18 inches away from the valve.

5. POWER SUPPLIES

5.1. Protective devices

Protective devices are desirable to prevent damage to the valve if the power supply or cooling arrangements fail.

5.2. Regulation

The regulation requirements can be determined with reference to the typical curves of gain, phase shift and electrode voltages.

The change in gain with electrode voltage is usually greatest for the current controlling electrode (normally the first grid) and the helix.

Any ripple voltage on the helix will give rise to phase modulation of the signal.

With an electromagnetic focusing system the solenoid current must be stabilised.

6. INSTALLATION SEQUENCE

When putting a valve into operation the initial adjustments should be made in the following order:

Ensure that the control electrode voltage is set at zero and then apply simultaneously the remaining electrode voltages and adjust in accordance with recommended values. Increase the control electrode voltage until cathode current is drawn, ensuring that the maximum helix current limit is not exceeded. Adjust the focus alignment screws so that the helix current is a minimum and the collector current is a maximum. Repeat this procedure until the required collector current is achieved and the helix current is a minimum. A typical helix current is given in the valve data under operating conditions.

Inject a low level radio frequency signal at the desired operating frequency ensuring that the valve is not saturated and observe the output level. Adjust the helix voltage until a maximum output level is achieved. Recheck for optimum focusing and lock focus alignment screws.

7. OPERATING SEQUENCE

The following sequence should be followed:

- a. Apply the heater voltage and allow the specified heater warm up time.
- b. Switch on the power supply of the electromagnetic focusing system.
- c. The electrode voltages may be applied simultaneously but it is preferable that the control electrode voltage be delayed with respect to the other electrode voltages.

8. SWITCHING OFF

All the electrode voltages may be removed simultaneously but it is preferable for the control electrode voltage to decrease more rapidly than the other electrode voltages.

Where an electromagnetic focusing arrangement is used the valve electrode voltages must be removed before switching off the solenoid power supply.

9. STORAGE

The valve should be stored in its original packing, which is designed to give reasonable protection against vibration and knocks. This also ensures that the spacing between permanent magnet valves and other ferrous objects is adequate to avoid reduction of magnetisation.

Unpacked permanent magnet valves should **NEVER** be placed on steel benches or shelves.



BACKWARD-WAVE OSCILLATOR

BAI6-10

Frequency: 'J' Band, electronically tunable.

Power output: 10mW minimum.

Construction: Demountable, prefocused capsule, with d.c. voltage isolation between the output connection and delay structure.

Modulation: Amplitude, pulse or frequency.

This data should be read in conjunction with GENERAL OPERATIONAL RECOMMENDATIONS - MICROWAVE DEVICES: INTRODUCTION and BACKWARD-WAVE OSCILLATORS which precede this section of the handbook.

CHARACTERISTICS

	Min.	Max.	
Frequency electronically tunable over the range	11	18	Gc/s
Delay structure voltage			
$f = 11\text{Gc/s}$	500	650	V
$f = 18\text{Gc/s}$	2.2	2.6	kV
Sensitivity over frequency range	2.0	9.0	Mc/s per V
Power output over frequency range	10	—	mW
Grid voltage for maximum output	—	0	V
for zero output	—	-100	V

CATHODE

Indirectly heated

V_{ih}	6.3	V
I_{ih}	1.5	A
$I_{h(\text{surge})}$ max.	4.0	A

The cathode must be heated for at least 2 minutes before application of h.t. voltage.

CAPACITANCES

$C_{h,k}$ all	10	pF
C_g all	13	pF
C_a all	6.0	pF
$C_{\text{delay structure}}$ all	8.0	pF

TYPICAL OPERATION

	11	14.5	17.5	
f				Gc/s
$V_{\text{delay structure}}$	0.57	1.2	2.12	kV
$I_{\text{delay structure}}$	9.2	9.0	9.8	mA
V_a	400	400	400	V
I_a	0.9	1.0	0.8	mA
V_g	0	0	0	V
P_{out}	30	70	60	mW

OPERATING SEQUENCE

See appropriate section in General operational recommendations—microwave devices: backward-wave oscillators.

COOLING

Forced-air (see curve on page C3)

T_{mount} max. (at specified point) 120 °C

ABSOLUTE MAXIMUM RATINGS

$V_{\text{delay structure}}$ max.	2.6	kV
$V_{\text{delay structure}}$ min.	500	V
$P_{\text{delay structure}}$ max.	40	W
I_k max.	30	mA
V_{H} max.	500	V
I_{H} max.	10	mA
V_R max.	0	V
$-V_R$ max.	150	V

MOUNTING POSITION

Any

PHYSICAL DATA

Weight (mount only) SB-1, SB-2 { 11 lb
5.0 kg

OUTPUT CONNECTION

Rectangular waveguide WG18 with bolted flange joint-services type 5985-99-0830030 to fit choke flange joint-services type 5985-99-0830029.

ACCESSORIES

Mount with aluminium foil solenoid for operation at low ambient temperatures SB-1

Mount with aluminium foil solenoid for operation at high ambient temperatures SB-2

SOLENOID OPERATING CONDITIONS

Both types are intended for constant current operation.

	SB-1	SB-2	
Current	7.5	13	A
Voltage	26	17	V
T_{amb}	25	25	°C
Cooling	Forced-air	Forced-air	

Outlet via waveguide WG:8 with bolted flange joint-services type 5985-99-0830030 to take flange choke coupling joint-services type 5985-99-0830029

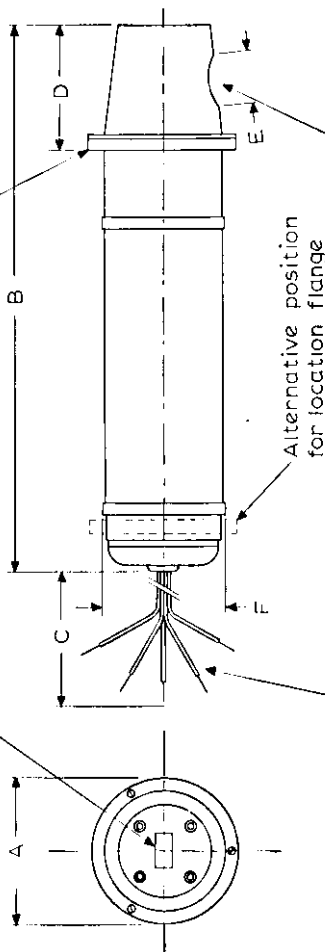

- Brown lead — heater
- Yellow lead — common heater cathode
- Red lead — delay structure
- Green lead — grid
- Blue lead — anode

7405

DIMENSIONS

	Inches	Millimetres	Inches	Millimetres
A	2.717 ± 0.002	69.00 ± 0.05	D	2.461 ± 0.039
B	9.843 ± 0.039	250 ± 1	E	1.000 ± 0.008
C	12	305 min.	F	2.284 ± 0.002
				58.00 ± 0.05

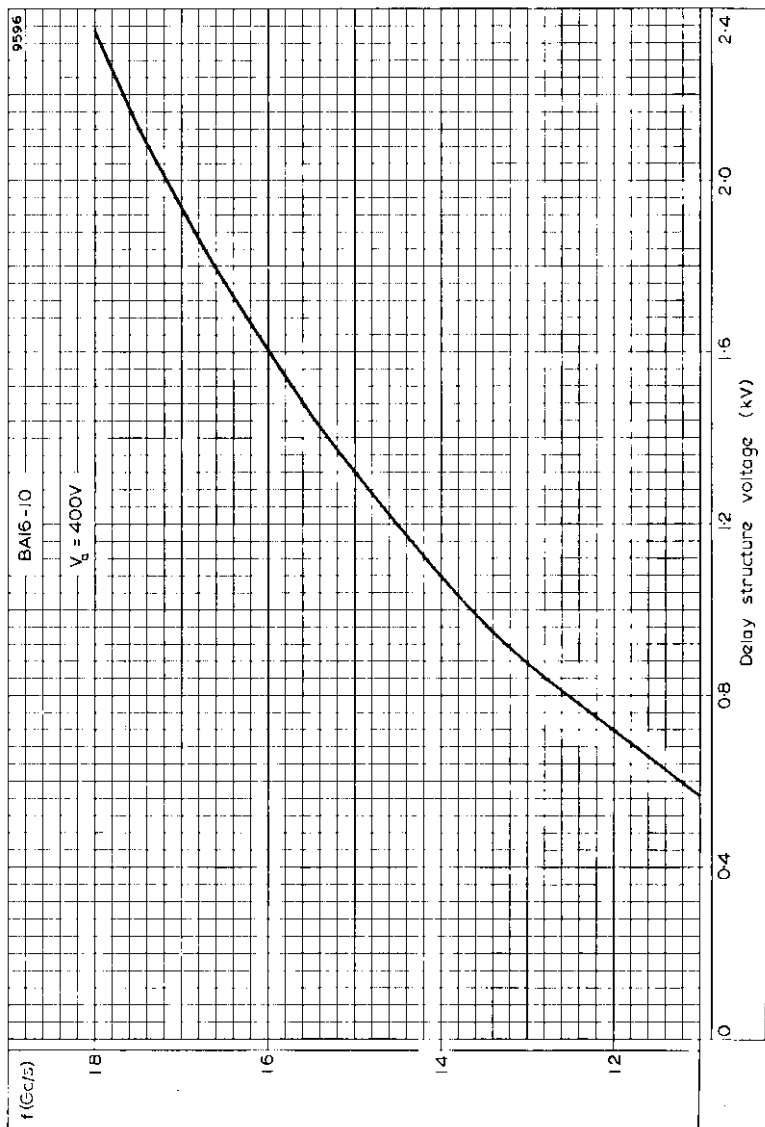

FREQUENCY PLOTTED AGAINST DELAY STRUCTURE VOLTAGE

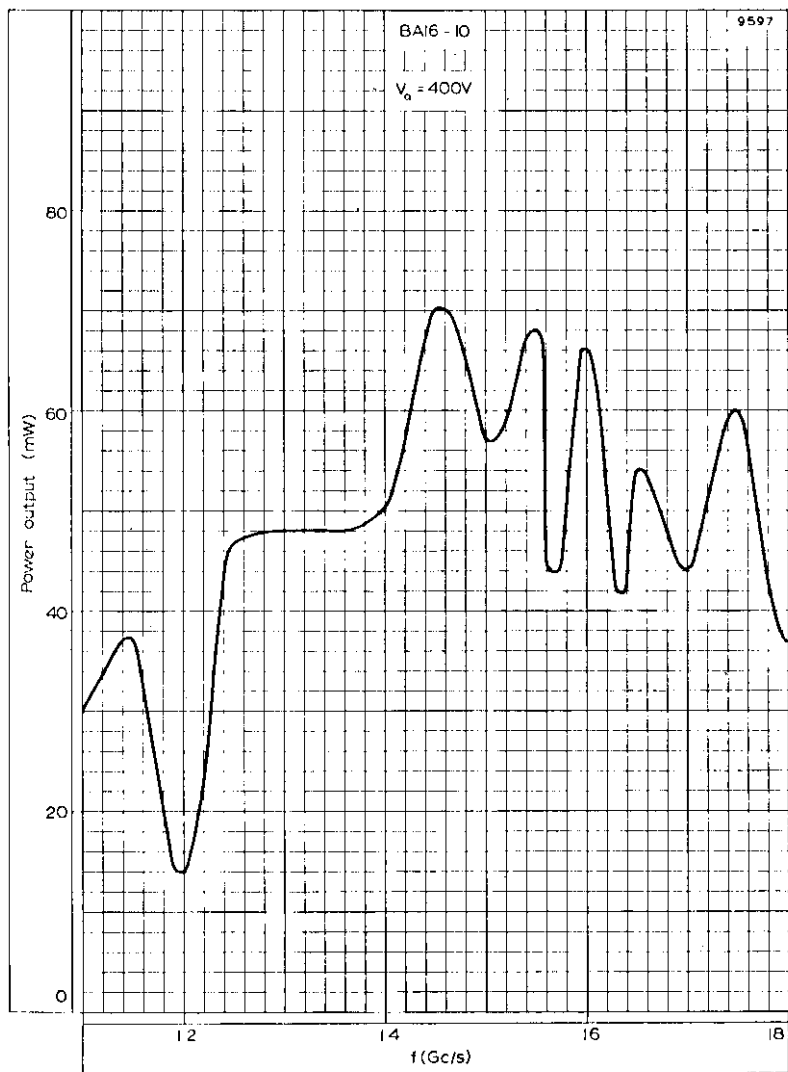

TYPICAL POWER OUTPUT PLOTTED AGAINST FREQUENCY

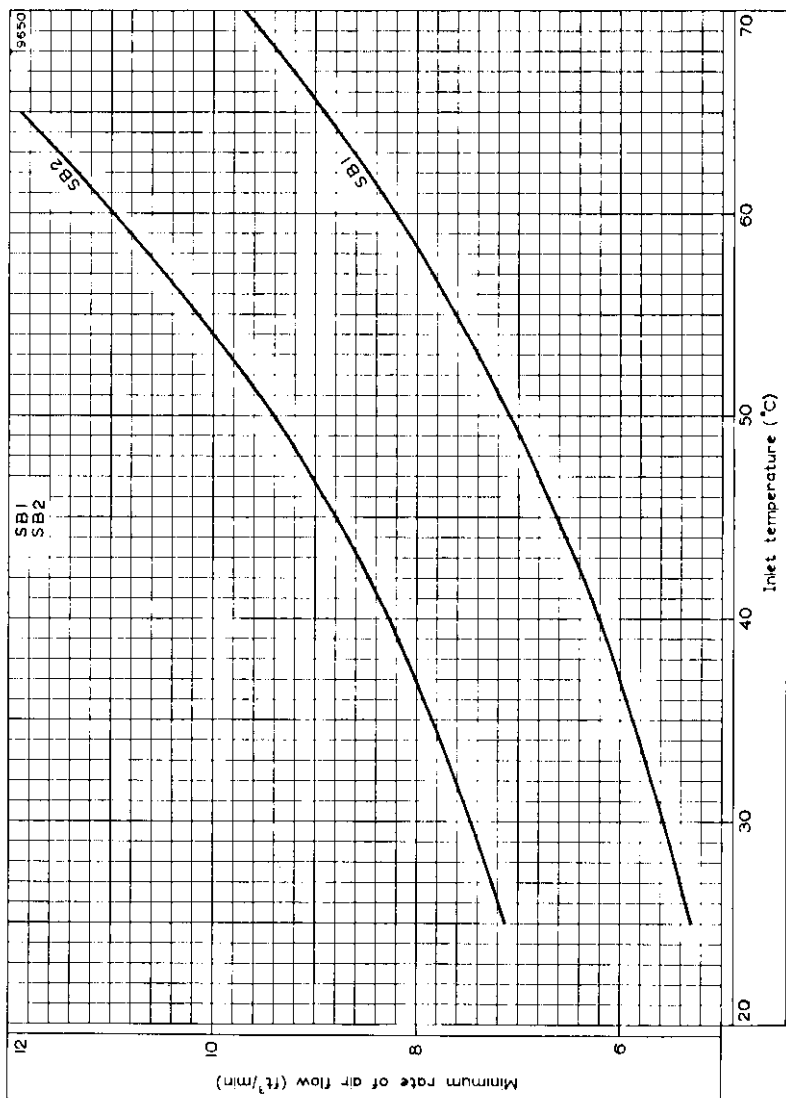

MINIMUM RATE OF AIR FLOW PLOTTED AGAINST INLET TEMPERATURE FOR MOUNTS SB-1 AND SB-2 FOR $T_{mount\ max.} = 120^{\circ}C$

QUICK REFERENCE DATA

Forward wave amplifier for use in power output stages of wideband multi-channel microwave links.

Frequency	5.9 to 6.5	GHz
Saturation power output	25	W
Gain	38	dB
Construction	Unpackaged	

To be read in conjunction with
GENERAL OPERATIONAL RECOMMENDATIONS - MICROWAVE DEVICES

OPERATING CONDITIONS

As a power amplifier with the collector earthed and tube focused in a mount type P6L11. (Electrode potentials with respect to cathode).

f	6.0	GHz
$V_{\text{collector}}$	2.0	kV
$I_{\text{collector}}$	45	mA
V_{helix}	3.4	kV
I_{helix}	0.4	mA
V_{g1}	-15	V
I_{g1}	1.0	μA
V_{g2}	2.2	kV
I_{g2}	5.0	μA
Gain	38	dB
Power output	15	W
Noise factor (including gas noise)	28	dB
Hot input match (v.s.w.r.)	1.2	
Hot output match (v.s.w.r.)	1.4	

CHARACTERISTICS

	Min.	Max.	
Tube in mount P6L11			
Frequency band	5.925	6.425	GHz
Gain ($P_{out} = 15\text{Watts}$)	37	40	dB
Noise factor ($P_{out} = 15\text{Watts}$)	-	30	dB
Saturation power output	23	-	W
Attenuation at $I_k = 0\text{mA}$	60	-	dB
Hot input match (v.s.w.r.)	-	1.8	
Hot output match (v.s.w.r.)	-	2.0	

CATHODE

Indirectly heated, dispenser cathode

* V_h d.c. or r.m.s.		6.3	V
I_h		0.85 to 1.05	A
t_{h-k} min.		2.0	min

* The absolute variation of the heater voltage should be less than $\pm 2\%$.
When operated on d.c. the heater must be positive with respect to the cathode.

RATINGS (ABSOLUTE MAXIMUM SYSTEM)

	Min.	Max.	
$V_{collector}$	1.8	2.2	kV
$I_{collector}$	-	50	mA
$P_{collector}$	-	100	W
V_{helix}	-	4.0	kV
I_{helix} during focusing (transient)	-	2.0	mA
I_{helix} during operation	-	1.5	mA
V_{g1}	-250	0	V
I_{g1}	-	1.0	mA
V_{g2}	-	3.0	kV
I_{g2}	-	1.0	mA
P_{in} signal	-	0.25	W
V_{h-k}	-	50	V



DESIGN RANGES FOR POWER SUPPLY

(Electrode potentials with respect to cathode)

	Min.	Max.	
For normal operation			
*V _{collector}	1.8	2.2	kV
V _{helix}	3.2	3.8	kV
**V _{g1}	-20	0	V
***V _{g2}	1.9	2.8	kV
I _{collector}	40	50	mA
I _{helix}	-	2.0	mA
I _{g1}	-	100	μA
I _{g2}	-250	+250	μA
V _h	6.15	6.45	V

*Normally 2.0kV

**Normally -15V

***For adjustment of focus it is necessary for V_{g2} to be made adjustable over the range 0 to 2.8kV.

MOUNTING POSITION

Any (but see cooling)

COOLING

Tube installed in mount P6L11 (convection cooled)

Horizontally mounted

Natural

Vertically mounted

Assisted by convection duct
or low velocity air flow

A conduction cooled mount is available.

Temperatures

Collector seal max.

200°C

Reference point max.

140°C

AMBIENT TEMPERATURE RANGES FOR MOUNT

Operation to full specification	-10 to +65	°C
Operation without damage to tube	-20 to +65	°C
Storage	-60 to +85	°C

PHYSICAL DATA

	kg	lb
Weight of LB6-25	0.2	0.4
Weight of LB6-25 and transit carton (2 valves per carton)	4.0	9.0
Weight of mount P6L11	5.5	12
Weight of P6L11 mount and transit carton	20.5	45
	cm	in
Dimensions of LB6-25 storage carton	40 × 10 × 10	16 × 4 × 4
Dimensions of P6L11 storage carton	50 × 27 × 14	20 × 11 × 6

OUTLINE DRAWING OF LB6-25

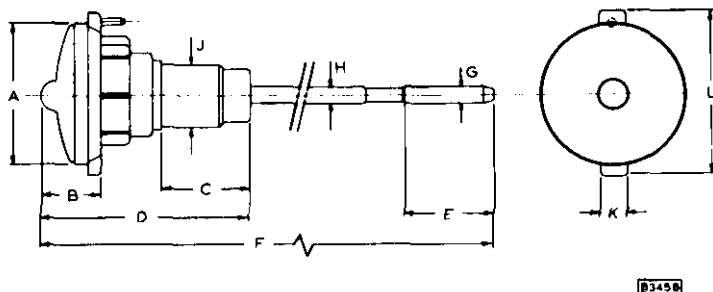

DIMENSIONS OF LB6-25

	Millimetres	Inches	
A	61	2.40	dia.
B	27	1.06	
C	29	1.14	max.
D	82 ± 1.0	3.228 ± 0.039	
E	45	1.77	
F	348	13.70	max.
G	$7.5 \begin{smallmatrix} +0 \\ -0.02 \end{smallmatrix}$	$0.2953 \begin{smallmatrix} +0 \\ -0.0008 \end{smallmatrix}$	dia.
H	7.5	0.295	dia. max.
J	31.5 ± 0.01	1.2402 ± 0.0004	dia.
K	12	0.47	
L	71	2.80	

Inch dimensions are derived from original millimetre dimensions

OUTLINE DRAWING OF P6L11 MOUNT



B7916

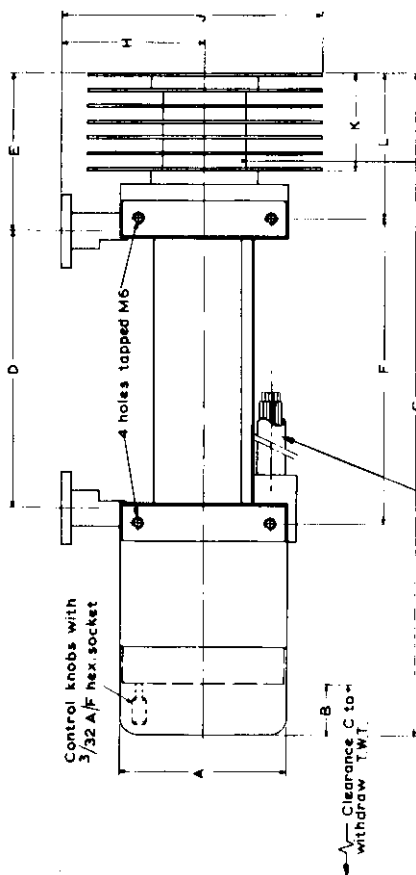
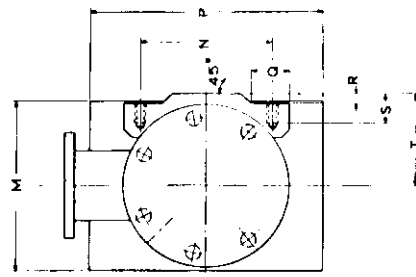

CABLE CONNECTIONS TO SOCKET	
1	HEATER BROWN
2	CATHODE YELLOW
3	GRID 1 GREEN
4	HELIX ORANGE
5	HEATER BROWN
6	GRID 2 BLUE
7	SAFETY SWITCH RED
8	SAFETY SWITCH RED

COLLECTOR & SCREENING EARTHED (BLACK)

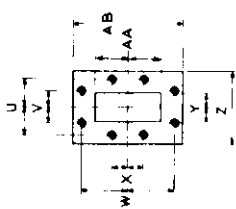
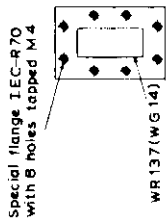

DIMENSIONS OF P6L11 MOUNT

	Millimetres	Inches	
A	89	3.50	dia.
B	28	1.10	
C	338	13.31	
D	149.2 ± 0.1	5.874 ± 0.004	
E	85	3.35	
F	163.0 ± 0.2	6.417 ± 0.008	
G	356	14.02	
H	76	2.99	
J	139	5.47	
K	52.5	2.067	
L	78	3.07	
M	92	3.62	
N	70.0 ± 0.2	2.756 ± 0.008	
P	125	4.92	
Q	20.0 ± 0.5	0.787 ± 0.020	
R	5.5 ± 0.2	0.217 ± 0.008	
S	16	0.63	
T	50	1.97	
U	14.99 ± 0.05	0.590 ± 0.002	
V	8.71 ± 0.05	0.343 ± 0.002	
W	17.42 ± 0.05	0.686 ± 0.002	
X	8.18 ± 0.05	0.322 ± 0.002	
Y	7.90 ± 0.05	0.311 ± 0.002	
Z	39.0 ± 0.3	1.535 ± 0.011	
AA	24.51 ± 0.05	0.965 ± 0.002	
AB	58.0 ± 0.3	2.283 ± 0.011	

Inch dimensions derived from original millimetre dimensions

QUICK REFERENCE DATA

Forward wave amplifier for use in power output stages of wideband multi-channel microwave links.

<i>Frequency</i>	8.4 to 7.2	GHz
Saturation power output	20	W
Gain	38	dB
Construction	Unpackaged	

To be read in conjunction with
GENERAL OPERATIONAL RECOMMENDATIONS-MICROWAVE DEVICES

OPERATING CONDITIONS

As a power amplifier with the collector earthed and tube focused in a mount type P6L11A (Electrode potentials with respect to cathode).

f	6.8	GHz
$V_{\text{collector}}$	2.0	kV
$I_{\text{collector}}$	45	mA
V_{helix}	3.5	kV
I_{helix}	0.4	mA
V_{g1}	-15	V
I_{g1}	1.0	μ A
V_{g2}	2.2	kV
I_{g2}	5.0	μ A
Gain	38	dB
<i>Power output</i>	10	W
Noise factor (including gas noise)	28	dB
Hot input match (v.s.w.r.)	1.2	
Hot output match (v.s.w.r.)	1.4	

CHARACTERISTICS

	Min.	Max.	
Tube in mount type P6L11A			
Frequency band	6.425	7.125	GHz
Gain ($P_{out} = 10$ watts)	37	40	dB
Noise factor ($P_{out} = 10$ watts)	-	30	dB
Saturation power output	20	-	W
Attenuation at $I_k = 0$ mA	60	-	dB
Hot input match (v.s.w.r.)		1.8	
Hot output match (v.s.w.r.)		2.0	

CATHODE

Indirectly heated, dispenser cathode

* V_h d.c. or r.m.s.	6.3	V
I_h	0.8	1.1 A
t_{h-k} min.		2.0 min

*The absolute variation of heater voltage should be less than $\pm 2\%$.

When operated on d.c. the heater must be positive with respect to the cathode.

RATINGS (ABSOLUTE MAXIMUM SYSTEM)

	Min.	Max.	
$V_{collector}$	1.8	2.2	kV
$I_{collector}$	-	50	mA
$P_{collector}$	-	100	W
V_{helix}	-	4.0	kV
I_{helix} during focusing (transient)	-	2.0	mA
I_{helix} during operation	-	1.5	mA
V_{g1}	-250	0	V
I_{g1}	-	1.0	mA
V_{g2}	-	3.0	kV
I_{g2}	-	1.0	mA
P_{in} signal	-	0.25	W
V_{h-k}	-	50	V

DESIGN RANGES FOR POWER SUPPLY

(Electrode potentials with respect to the cathode)

	Min.	Max.	
For normal operation			
$V_{\text{collector}}$ (fixed in range)	1.8	2.5	kV
V_{helix}	3.2	3.8	kV
V_{g1}	-20	0	V
* V_{g2}	1.9	2.8	kV
$I_{\text{collector}}$	40	50	mA
I_{helix}	-	2.0	mA
I_{g1}	-	100	μ A
I_{g2}	-	500	μ A
V_h	6.15	6.45	V

*For adjustment of focus it is necessary for V_{g2} to be made adjustable over the range:- 0 to 2.8kV.

MOUNTING POSITION

Any
(but see cooling)

COOLING

Tube installed in mount P6L11A (convection cooled)

Horizontally mounted

Natural

Vertically mounted

Assisted by convection duct
or low velocity air flow

A conduction cooled mount is available

Temperatures

Collector seal max.

200

$^{\circ}$ C

Reference point max.

140

$^{\circ}$ C

AMBIENT TEMPERATURE RANGES FOR MOUNT

Operation to full specification	-10 to +65	°C
Operation without damage to tube	-20 to +65	°C
Storage	-60 to +85	°C

PHYSICAL DATA

	kg	lb
Weight of LB6-25A	0.2	0.4
Weight of LB6-25A and transit carton (2 valves per carton)	4.0	9.0
Weight of mount P6L11A	5.5	12
Weight of P6L11A mount and transit carton	20.5	45

	cm	in
Dimensions of LB6-25A storage carton	40 × 10 × 10	16 × 4 × 4
Dimensions of P6L11A storage carton	50 × 27 × 14	20 × 11 × 6

OUTLINE DRAWING OF LB6-25A

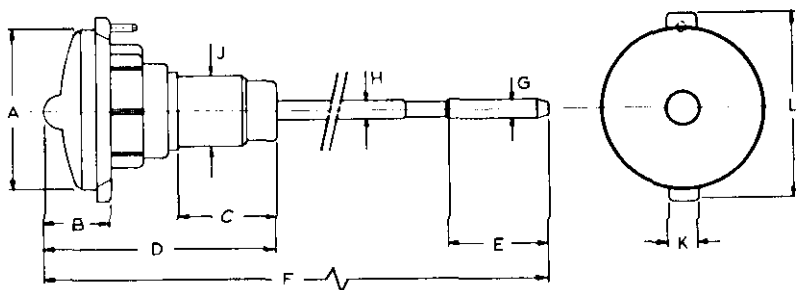

B3456

DIMENSIONS OF LB6-25A

	Millimetres	Inches	
A	61	2.40	dia.
B	27	1.06	
C	29	1.14	max.
D	82 ± 1.0	3.228 ± 0.039	
E	45	1.77	
F	348	13.70	max.
G	7.5 ⁺⁰ -0.02	0.2953 ⁺⁰ -0.0008	dia.
H	7.5	0.295	dia. max.
J	31.5 ± 0.01	1.2402 ± 0.0004	dia.
K	12	0.47	
L	71	2.80	

Inch dimensions are derived from original millimetre dimensions

OUTLINE DRAWING OF P6L-11A MOUNT

B7918

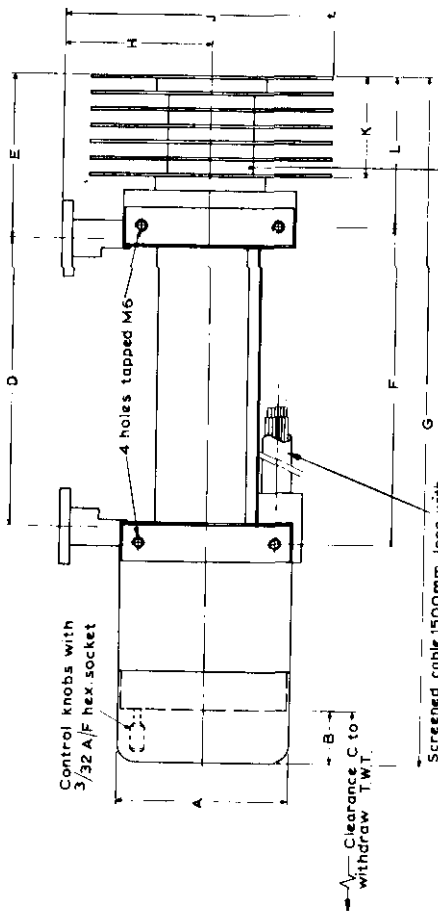
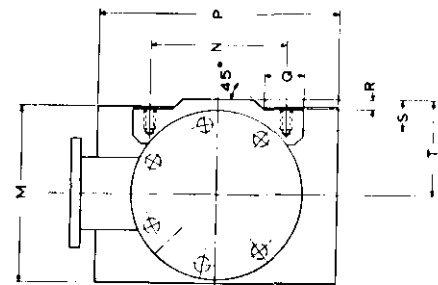

Control knobs with 3/32 A/F hex socket

4 holes tapped M6

Clearance C to withdraw T.W.T.

Screened cable 1500mm long with safety switch leads Switch operated by insertion and extraction of T.W.T.

Temperature reference point.

Special flange IEC-R70 with 8 holes tapped M4

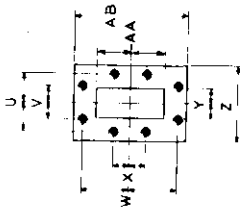

CABLE CONNECTIONS TO SOCKET	
1 HEATER	BROWN
2 CATHODE	YELLOW
3 GRID 1	GREEN
4 HELIX	ORANGE
5 HEATER	BROWN
6 GRID 2	BLUE
7 SAFETY SWITCH	RED
8 SAFETY SWITCH	RED

COLLECTOR & SCREENING EARTHED (BLACK)



DIMENSIONS OF P6L11A MOUNT

	Millimetres	Inches	
A	89	3.50	dia.
B	28	1.10	
C	338	13.31	
D	149.2 ± 0.1	5.874 ± 0.004	
E	85	3.35	
F	163.0 ± 0.2	6.417 ± 0.008	
G	356	14.02	
H	76	2.99	
J	139	5.47	
K	52.5	2.067	
L	78	3.07	
M	92	3.62	
N	70.0 ± 0.2	2.756 ± 0.008	
P	125	4.92	
Q	20.0 ± 0.5	0.787 ± 0.020	
R	5.5 ± 0.2	0.217 ± 0.008	
S	16	0.63	
T	50	1.97	
U	14.99 ± 0.05	0.590 ± 0.002	
V	8.71 ± 0.05	0.343 ± 0.002	
W	17.42 ± 0.05	0.686 ± 0.002	
X	8.18 ± 0.05	0.322 ± 0.002	
Y	7.90 ± 0.05	0.311 ± 0.002	
Z	39.0 ± 0.3	1.535 ± 0.011	
AA	24.51 ± 0.05	0.965 ± 0.002	
AB	58.0 ± 0.3	2.283 ± 0.011	

Inch dimensions derived from original millimetre dimensions

FORWARD WAVE AMPLIFIER

LB4-8

Application: Power amplifier.
Frequency: 4Gc/s band.
Construction: Unpackaged.

PRELIMINARY DATA

This data should be read in conjunction with GENERAL OPERATIONAL RECOMMENDATIONS - MICROWAVE DEVICES which precede this section of the handbook.

CHARACTERISTICS

	Min.	Max.	
Frequency band	3.8	4.2	Gc/s
Gain ($P_{out} = 3W$)	35	—	dB
Noise factor	—	30	dB
Saturation power output	8.0	—	W
Attenuation ($I_k = 0mA$)	60	—	dB

CATHODE

Indirectly heated

V_h		6.3	V
I_h		800	mA
Minimum cathode heating time		5.0	min

The absolute maximum variation of heater voltage should be less than $\pm 2\%$.

COOLING

$T_{collector}$ max.		175	$^{\circ}C$
$T_{ambient} < 55^{\circ}C$		Convection cooled	
$T_{ambient} > 55^{\circ}C$		Low velocity air-flow	

OPERATING CONDITIONS

As a power amplifier with the helix earthed and using a permanent magnet system of approved design.

All voltages are with respect to the helix which is connected to the mount.

f		3.9	Gc/s
$V_{collector}$		+50	V
V_{helix}		0	V
V_{R1}		0	V
V_k (approx.)		-1.1	kV
$I_{collector}$		50	mA
I_{helix}		< 3.0	mA
I_{a1}		< 250	μA
Gain		37	dB
P_{out}		5.0	W
Cold input match v.s.w.r.		< 1.5	
Cold output match v.s.w.r.		< 1.5	

LIMITING VALUES (absolute ratings)

All voltages are with respect to the cathode.

$V_{\text{collector max.}}$	1.5	kV
$P_{\text{collector max.}}$	70	W
$V_{\text{helix max.}}$	1.5	kV
$I_{\text{helix max.}}$	4.0	mA
$V_{\text{a1 max.}}$	1.5	kV
$V_{\text{a1 helix max.}}$	500	V
$I_{\text{a1 max.}}$	250	μA
$I_{\text{k max.}}$	55	mA

ACCESSORY

Mount Permanent magnet

PL4-4

6425

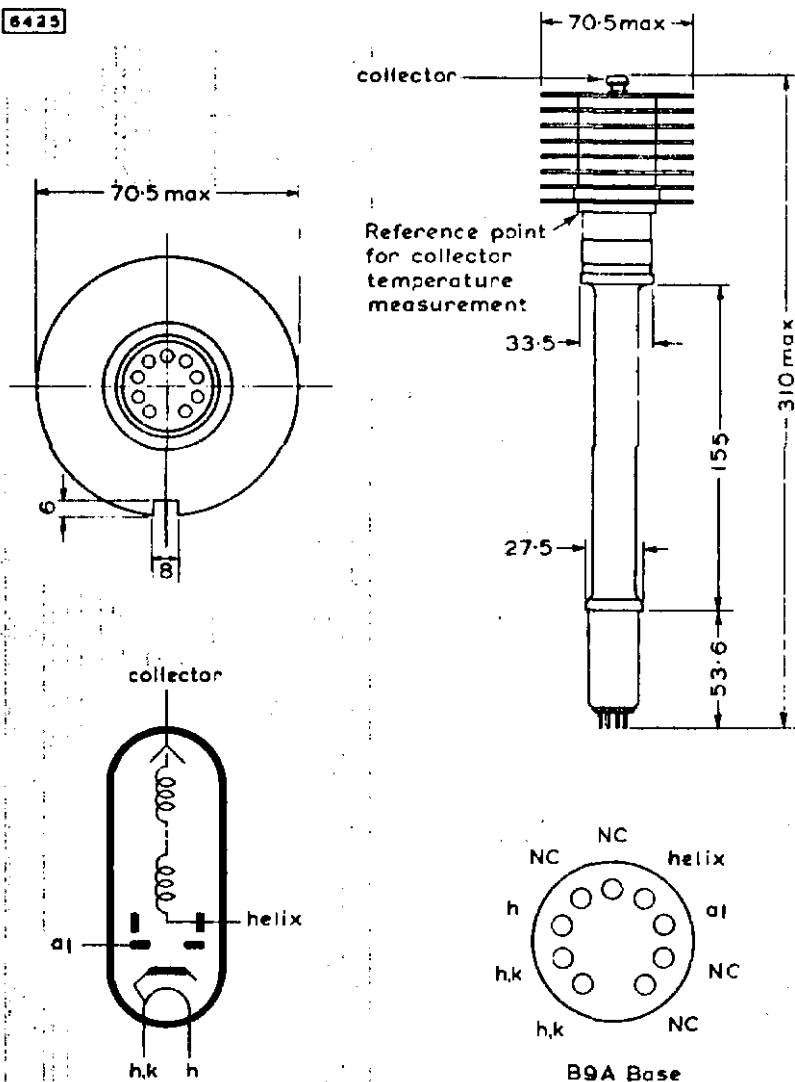

All dimensions in mm

Contacts 2 and 3 should be connected to the heater supply. Contact 1 is intended as the cathode or anode circuit return.

QUICK REFERENCE DATA

Forward wave amplifier suitable for use in the power output stages of wideband multi-channel microwave links.

Frequency	6	Gc/s band
Saturation power output	12	W
Gain	37	dB
Construction		Unpackaged

This data should be read in conjunction with GENERAL OPERATIONAL RECOMMENDATIONS - MICROWAVE DEVICES: INTRODUCTION and FORWARD WAVE AMPLIFIERS which precede this section of the handbook.

CHARACTERISTICS

Tube in mount - type P6L-3

	Min.	Max.	
Frequency band	5.900	7.125	Gc/s
Gain (over frequency band)			
$P_{out} = 100mW$	37	—	dB
$P_{out} = 5.0W$	33	—	dB
Noise factor ($P_{out} = 5.0W$)	—	30	dB
Saturation power output	10	—	W
Attenuation (at $I_k = 0mA$)	65	—	dB
Hot input match			v.s.w.r.
Over any 50Mc/s in band with matching device adjusted	—	1.2	
Over 5.9 to 6.4Gc/s without use of matching device	—	1.7	
Hot output match			v.s.w.r.
Over any 50Mc/s in band with matching device adjusted	—	1.3	
Over 5.9 to 6.4Gc/s without use of matching device	—	2.0	

CATHODE

Indirectly heated

V_h	6.3	V
I_h	0.9	A
$t_{h k}$ min.	2.0	min

The absolute maximum variation of the heater voltage should be less than $\pm 4\%$.

DESIGN RANGES FOR POWER SUPPLY

	<i>Min.</i>	<i>Max.</i>	
For adjustment of focus			
(a) Variable V_{R1}			
V_{R1}	0	-200	V
V_{R2}	1.6	2.3	kV
(b) Variable V_{R2}			
V_{R1}	0	-20	V
V_{R2}	0.3	2.3	kV
For normal operation			
$V_{\text{collector}}$	1.6	1.8	kV
V_{helix}	2.5	2.9	kV
V_{R1}	0	-20	V
V_{R2}	1.6	2.3	kV

TYPICAL OPERATION

As a power amplifier with the collector earthed and using a mount type P6L-3

f	6.5	Gc/s
$V_{\text{collector}}$	1.7	kV
V_{helix}	2.65	kV
V_{R2}	1.9	kV
V_{R1}	-8.0	V
$I_{\text{collector}}$	40	mA
I_{helix}	0.25	mA
Gain	37	dB
Power output	5.0	W
Typical noise factor (inclusive of any gas noise)	25	dB
Hot input match with matching device adjusted	v.s.w.r.	
At 6.5Gc/s		1.02
At ± 25 Mc/s about 6.5Gc/s		1.08
Hot output match with matching device adjusted	v.s.w.r.	
At 6.5Gc/s		1.02
At ± 25 Mc/s about 6.5Gc/s		1.15

ABSOLUTE MAXIMUM RATINGS

	<i>Min.</i>	<i>Max.</i>	
$V_{\text{collector}}$	1.5	1.8	kV
$I_{\text{collector}}$	—	45	mA
$P_{\text{collector}}$	—	80	W
V_{helix}	—	3.0	kV
I_{helix}	—	2.5	mA
during focusing	—	1.5	mA
during operation	—	3.0	kV
V_{R2}	—	1.0	mA
I_{R2}	—	250	V
$-V_{R1}$	—	1.0	W
P_{in} (signal)	—	50	V
$V_{\text{th k}}$	—		

MOUNTING POSITION

Any

COOLING**Tube installed in mount type P6L-3**

Horizontally mounted

Natural

Vertically mounted

Natural assisted by convection duct
or low velocity air flow $T_{\text{collector seal max.}}$

200

°C

Ambient temperature range for operation
to full specification

-10 to +65

°C

Ambient temperature range for operation
to reduced specification

-25 to +65

°C

Storage temperature at 95% humidity

-60 to +85

°C

PHYSICAL DATA

Weight of LB6-12

{	7.5	oz
	212.6	g

Weight of LB6-12 in carton

{	9lb	4oz
	4.2	kg

Dimensions of storage carton

{	17 × 17 × 29	in
	432 × 432 × 736.6	mm

Weight of P6L-3 mount

{	11lb	8 oz
	5.2	kg

Weight of P6L-3 mount in carton

{	40lb	10 oz
	18.4	kg

Dimensions of storage carton

{	25 × 16 × 19.5	in
	635 × 407 × 496	mm



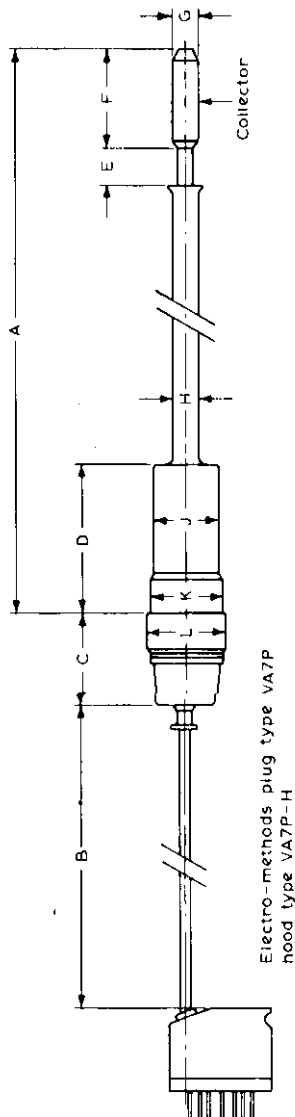

DIMENSIONS OF LB6-12

	Inches	Millimetres
A	12.48 ± 0.80	317 ± 2.0
B	3.62 ± 0.12	92 ± 3.0
C	1.033 ± 0.034	26.25 ± 0.85
D	2.1	53.3
E	0.632 ± 0.060	16.5 ± 1.5
F	1.772 ± 0.002	45 ± 0.6
G	0.294 ± 0.001	7.475 ± 0.025
H	0.295	7.5
J	1.06	27.5
K	1.238 ± 0.001	31.47 ± 0.02
L	1.32	33.5

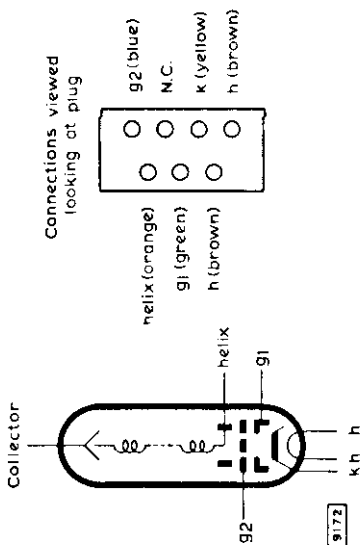

OUTLINE LB6-12



DIMENSIONS OF P6L-3 MOUNT

	<i>Inches</i>	<i>Millimetres</i>	
M	3.46 ± 0.02	88 ± 0.5	
N	6.84 ± 0.02	173.8 ± 0.5	
P	5.91 ± 0.02	150 ± 0.5	
Q	1.45 ± 0.02	36.9 ± 0.5	
R	1.18 ± 0.02	30 ± 0.5	
S	2.83 ± 0.02	72 ± 0.5	
T	1.34 ± 0.02	34 ± 0.5	
U	3.94 ± 0.02	100 ± 0.5	
V	1.34 ± 0.02	34 ± 0.5	
W	3.5 ± 0.02	89 ± 0.5	
X	5.12 ± 0.02	130 ± 0.5	
Y	2.17 ± 0.02	55 ± 0.5	dia.
Z	4.02 ± 0.02	102 ± 0.5	dia.
AA	24 ± 0.02	609.6 ± 0.5	
BB	2.00 ± 0.02	50.8 ± 0.5	
CC	0.50 ± 0.02	12.7 ± 0.5	
DD	0.655 ± 0.001	16.66 ± 0.025	
EE	1.094 ± 0.001	27.78 ± 0.025	
FF	1.531 ± 0.001	38.88 ± 0.025	
GG	2.188 ± 0.001	55.57 ± 0.025	
HH	2.69 ± 0.02	68.32 ± 0.5	
JJ	0.406 ± 0.001	10.31 ± 0.025	
KK	0.719 ± 0.001	18.26 ± 0.025	
LL	1.030 ± 0.001	26.18 ± 0.025	
MM	1.438 ± 0.001	36.52 ± 0.025	
NN	1.94 ± 0.02	49.27 ± 0.5	
PP	0.622 ± 0.001	15.8 ± 0.025	
QQ	1.372 ± 0.001	34.85 ± 0.025	
RR	1.980 ± 0.001	5.03 ± 0.025	dia.

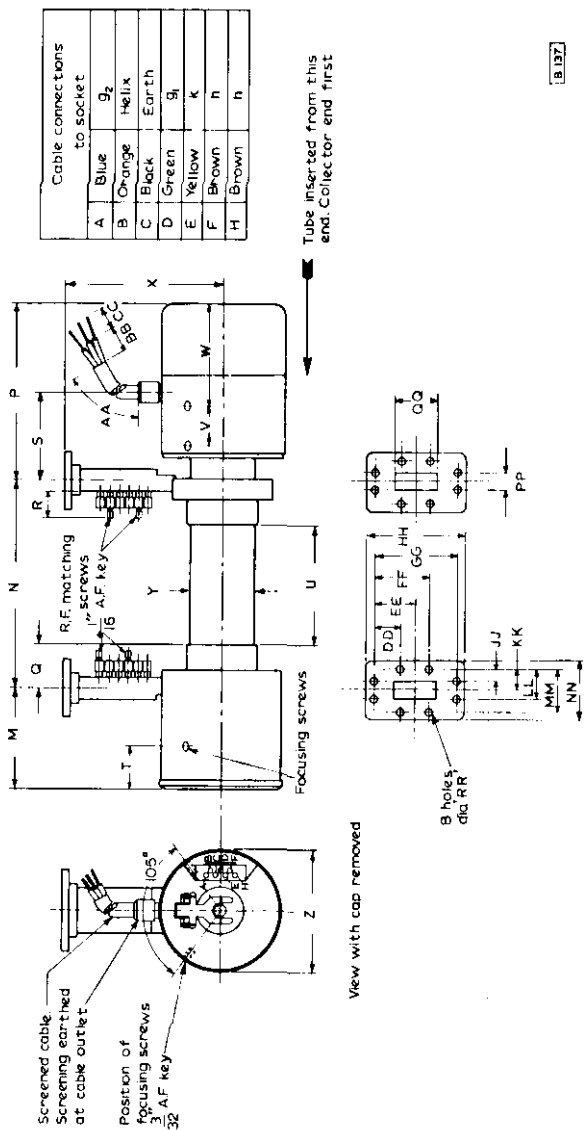

B 137

OUTLINE P6L-3 MOUNT



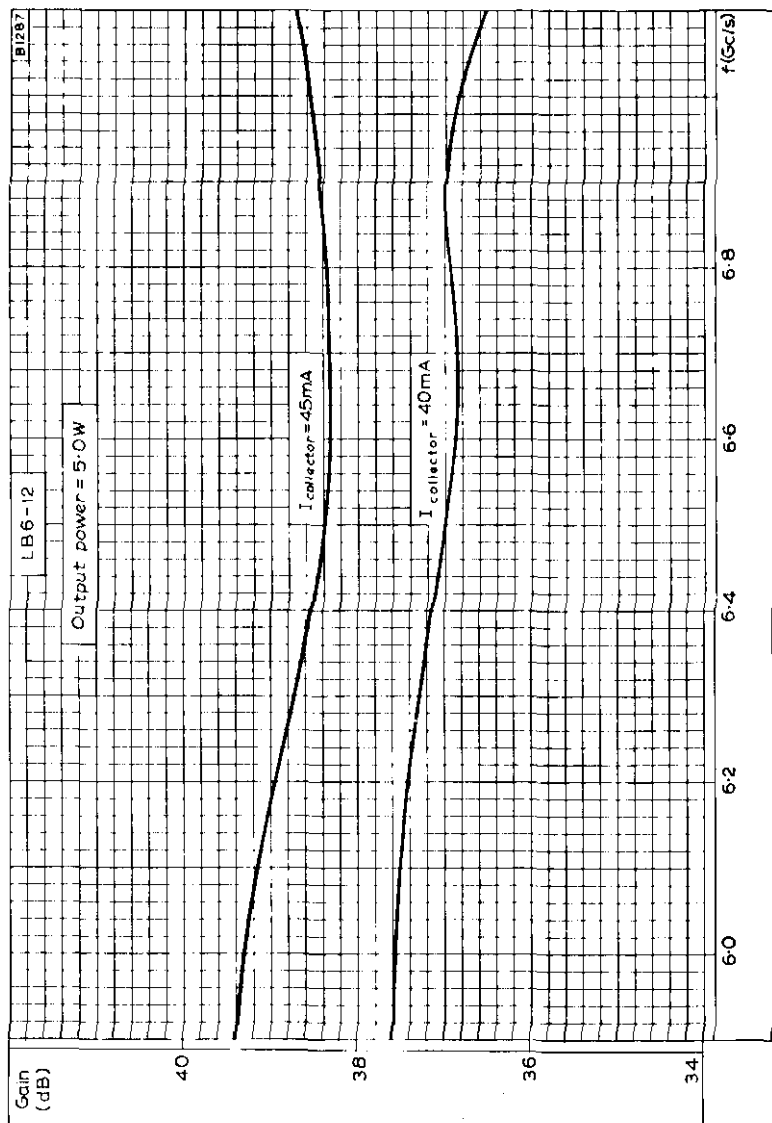

TYPICAL GAIN PLOTTED AGAINST FREQUENCY

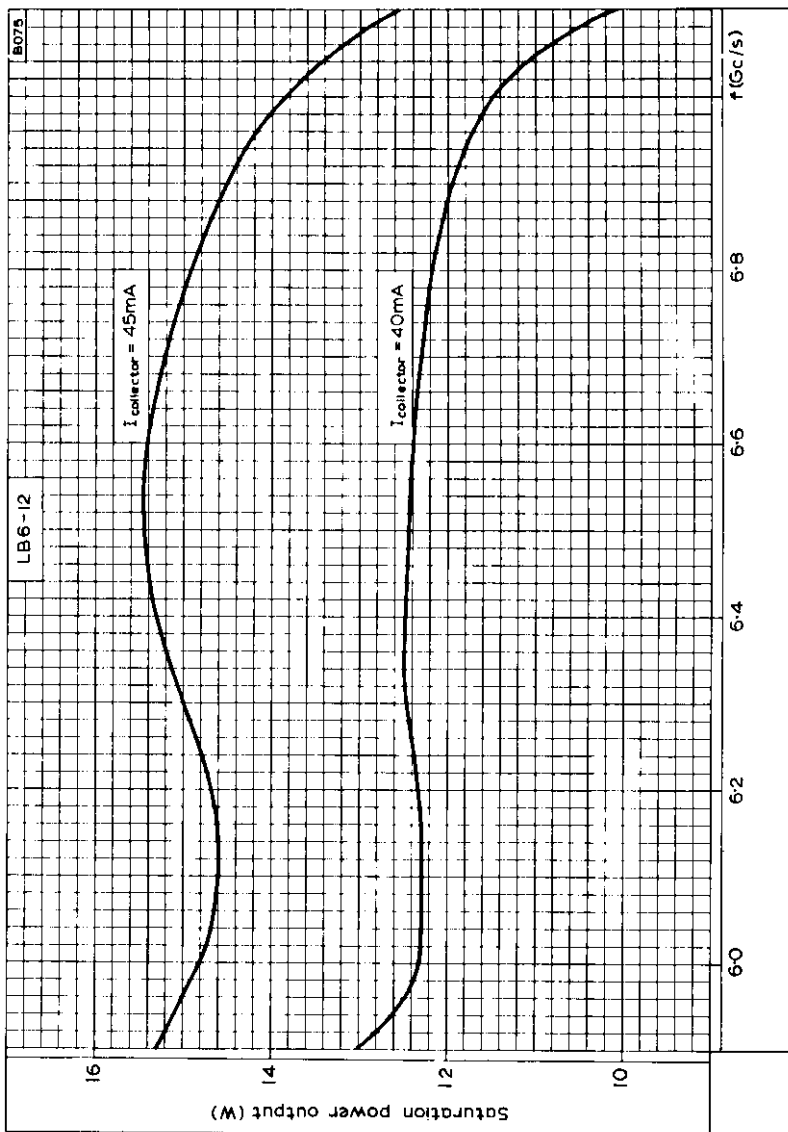

SATURATION POWER OUTPUT PLOTTED AGAINST FREQUENCY

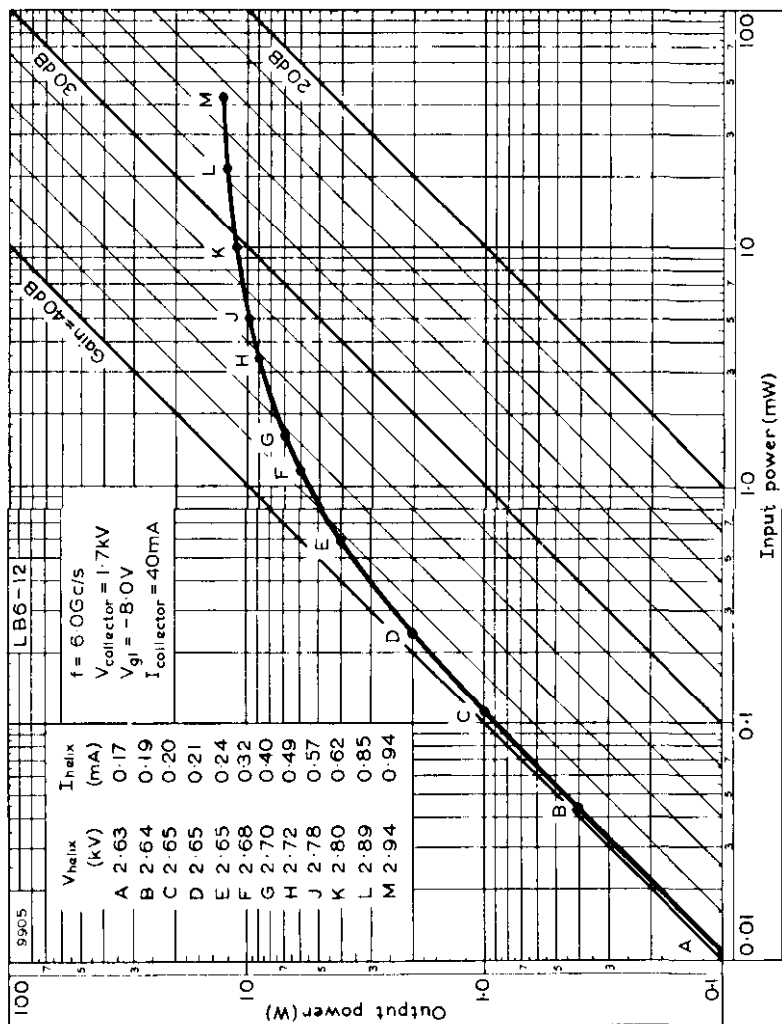

OUTPUT POWER PLOTTED AGAINST INPUT POWER AT 6.0Gc/s WITH A COLLECTOR CURRENT OF 40mA

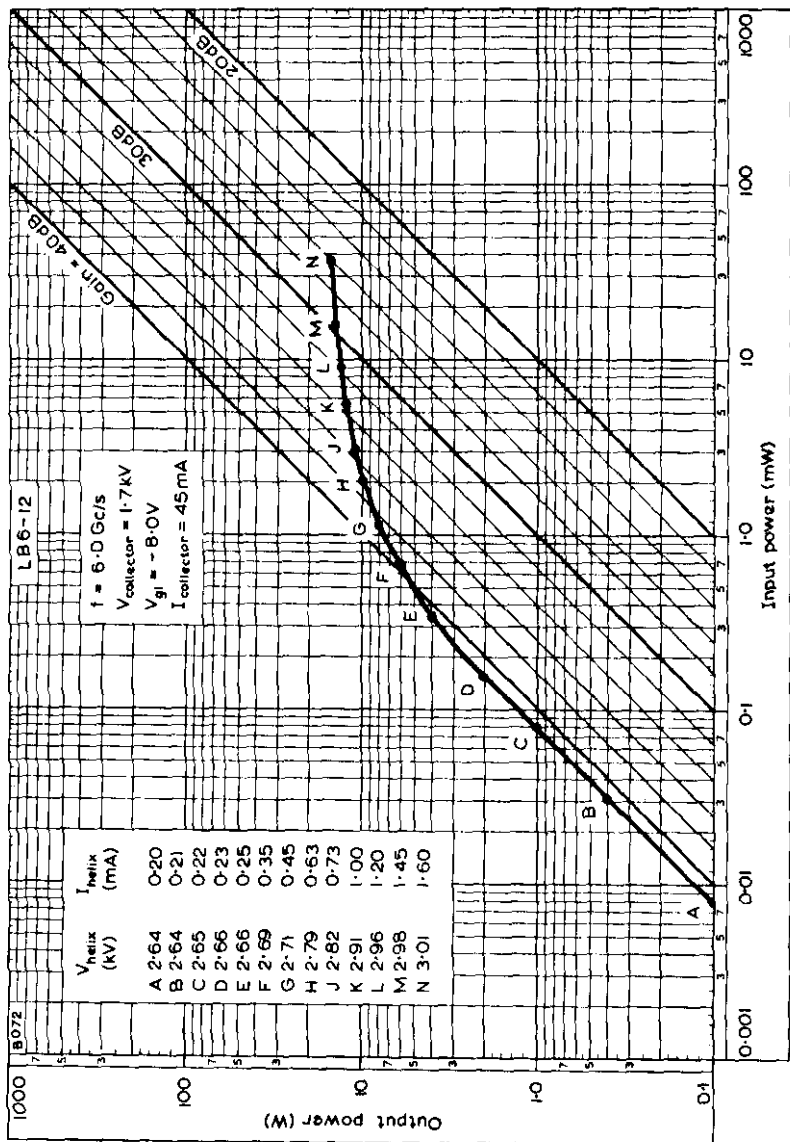

OUTPUT POWER PLOTTED AGAINST INPUT POWER AT 6.0Gc/s WITH A COLLECTOR CURRENT OF 45mA

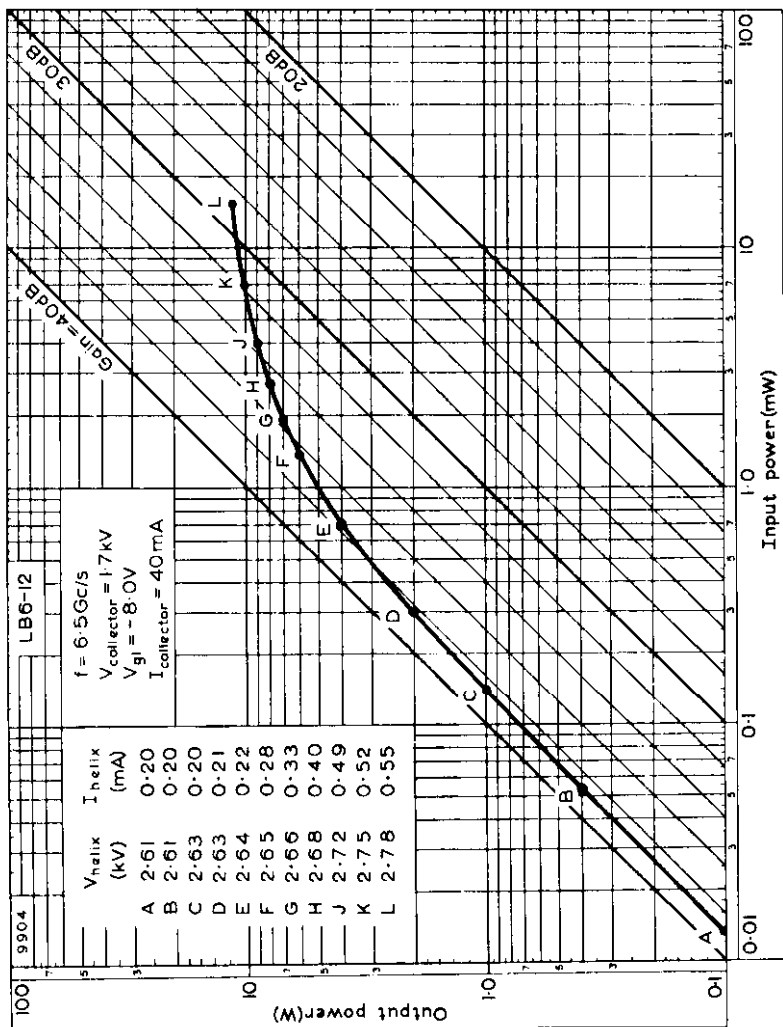

OUTPUT POWER PLOTTED AGAINST INPUT POWER AT 6.5Gc/s WITH A COLLECTOR CURRENT OF 40mA

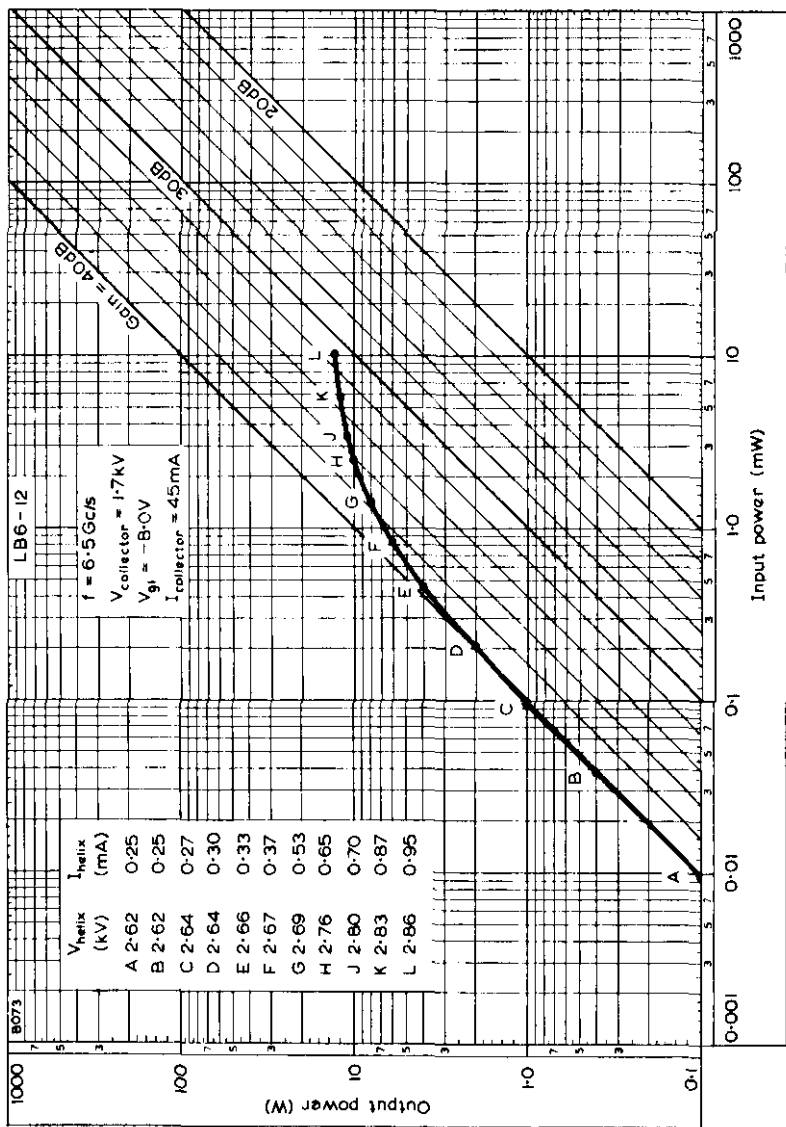

OUTPUT POWER PLOTTED AGAINST INPUT POWER AT 6.5Gc/s WITH A COLLECTOR CURRENT OF 45mA

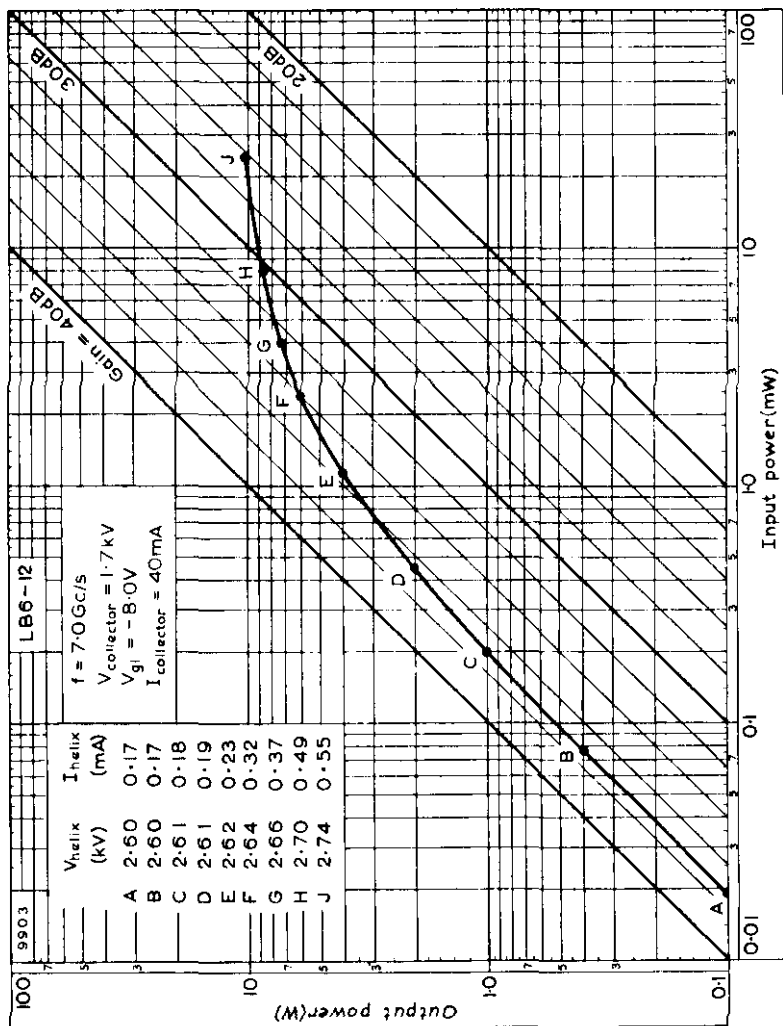

OUTPUT POWER PLOTTED AGAINST INPUT POWER AT 7.0Gc/s WITH A COLLECTOR CURRENT OF 40mA

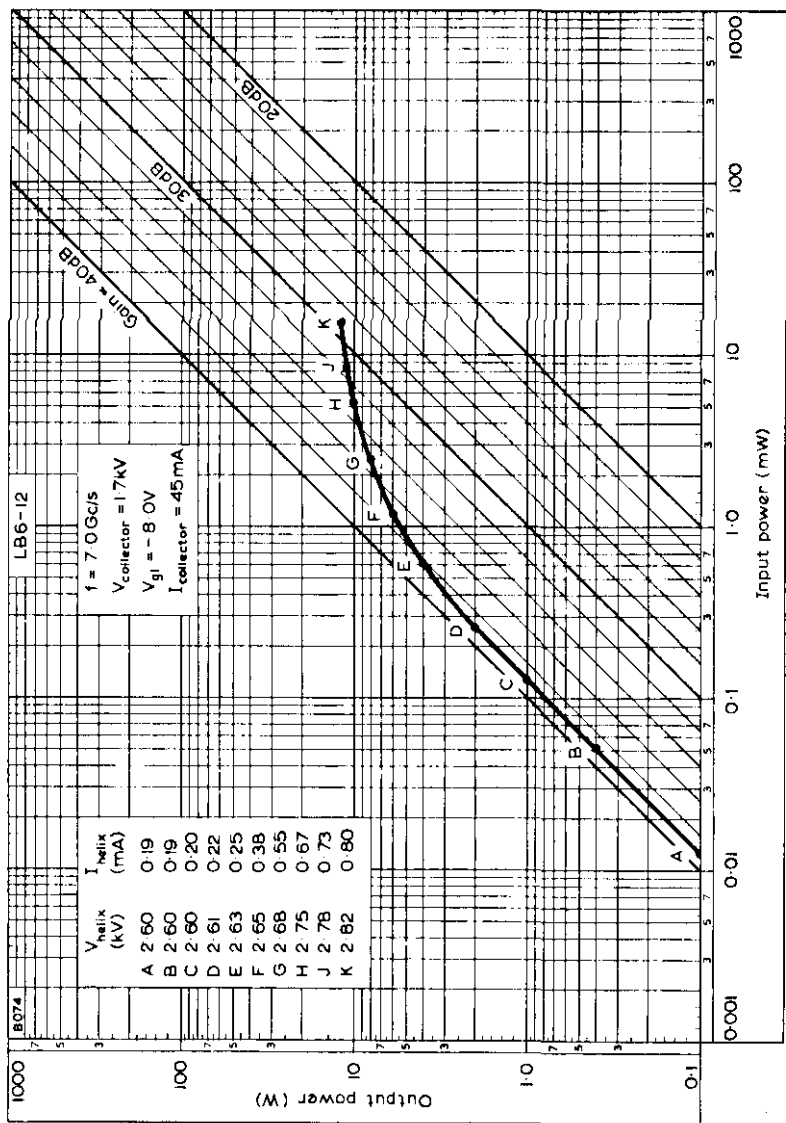

OUTPUT POWER PLOTTED AGAINST INPUT POWER AT 7.0Gc/s WITH A COLLECTOR CURRENT OF 45mA

QUICK REFERENCE DATA		
Frequency	5.9 - 6.5	GHz
Saturation power output	25	W
Gain	38	dB
Construction	Unpackaged	

To be read in conjunction with
GENERAL OPERATIONAL RECOMMENDATIONS - MICROWAVE DEVICES

OPERATING CONDITIONS

As a power amplifier with the collector earthed and tube focused in a mount type P6L-11. (Electrode potentials with respect to cathode).

f	6.0	GHz
V _{collector}	2.0	kV
I _{collector}	45	mA
V _{helix}	3.4	kV
I _{helix}	0.4	mA
V _{g1}	-15	V
I _{g1}	1.0	μA
V _{g2}	2.2	kV
I _{g2}	5.0	μA
Gain	37	dB
Power output	15	W
Noise factor (including gas noise)	28	dB
Hot input match (v.s.w.r.)	1.2	
Hot output match (v.s.w.r.)	1.4	

CHARACTERISTICS

	Min.	Max.	
Tube in mount P6L-11			
Frequency band	5.925	6.425	GHz
Gain ($P_{out} = 15\text{Watts}$)	37	40	dB
Noise factor ($P_{out} = 15\text{Watts}$)	-	30	dB
Saturation power output	23	-	W
Attenuation at $I_k = 0\text{mA}$	60	-	dB
Hot input match (v.s.w.r.)	-	1.8	
Hot output match (v.s.w.r.)	-	2.0	

CATHODE

Indirectly heated, dispenser cathode

V_h d.c. or r.m.s.		6.3	V
I_h		0.85 to 1.05	A
t_{h-k} min.		2.0	min

The absolute variation of the heater voltage should be less than $\pm 2\%$.

The heater/cathode connection must be positive when running on d.c.

RATINGS (ABSOLUTE MAXIMUM SYSTEM)

	Min.	Max.	
$V_{collector}$	1.8	2.2	kV
$I_{collector}$	-	50	mA
$P_{collector}$	-	100	W
V_{helix}	-	4.0	kV
I_{helix} during focusing (transient)	-	2.0	mA
I_{helix} during operation	-	1.5	mA
V_{g1}	-250	0	V
I_{g1}	-	1.0	mA
V_{g2}	-	3.0	kV
I_{g2}	-	1.0	mA
P_{in} signal	-	0.25	W
V_{h-k}	-	50	V

DESIGN RANGES FOR POWER SUPPLY

(Electrode potentials with respect to cathode)

	Min.	Max.	
For normal operation			
*V _{collector}	1.8	2.2	kV
V _{helix}	3.2	3.8	kV
**V _{g1}	-20	0	V
***V _{g2}	1.9	2.8	kV
I _{collector}	40	50	mA
I _{helix}	-	2.0	mA
I _{g1}	-	100	μA
I _{g2}	-250	+250	μA
V _h	6.15	6.45	V

*Normally 2.0kV

**Normally -15V

***For adjustment of focus it is necessary for V_{g2} to be made adjustable over the range 0 to 2.8kV.

MOUNTING POSITION

Any (but see cooling)

COOLING

Tube installed in mount P6L-11

Horizontally mounted

Natural

Vertically mounted

Assisted by convection duct
or low velocity air flow

T_{collector seal}

200°C maximum (Maximum
temperature at reference
point 140°C)

A conduction cooled mount is available.

AMBIENT TEMPERATURE RANGES FOR MOUNT

Operation to full specification	-10 to +65	°C
Operation without damage to tube	-20 to +65	°C
Storage	-60 to +85	°C

PHYSICAL DATA

	kg	lb
Weight of LB6-25	0.2	0.4
Weight of LB6-25 and transit carton (2 valves per carton)	4.0	9.0
Weight of mount P6L-11	5.5	12
Weight of P6L-11 mount and transit carton	20.5	45
	cm	in
Dimensions of LB6-25 storage carton	40 × 10 × 10	16 × 4 × 4
Dimensions of P6L-11 storage carton	50 × 27 × 14	20 × 11 × 6

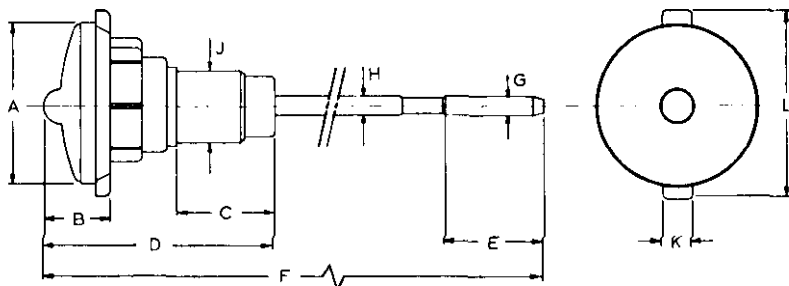

B3458

DIMENSIONS OF LB6-25

	Millimetres	Inches	
A	61	2.402	dia.
B	27	1.063	
C	29	1.142	max.
D	82±1.0	3.228±0.039	
E	45	1.772	
F	348	13.700	max.
G	7.5 ⁺⁰ -0.02	0.295 ⁺⁰ -0.001	dia.
H	7.5	0.295	dia. max.
J	31.5±0.01	1.240	dia.
K	12	0.472	
L	71	2.795	

Inch dimensions are derived from original millimetre dimensions

OUTLINE DRAWING OF P61.-11 MOUNT

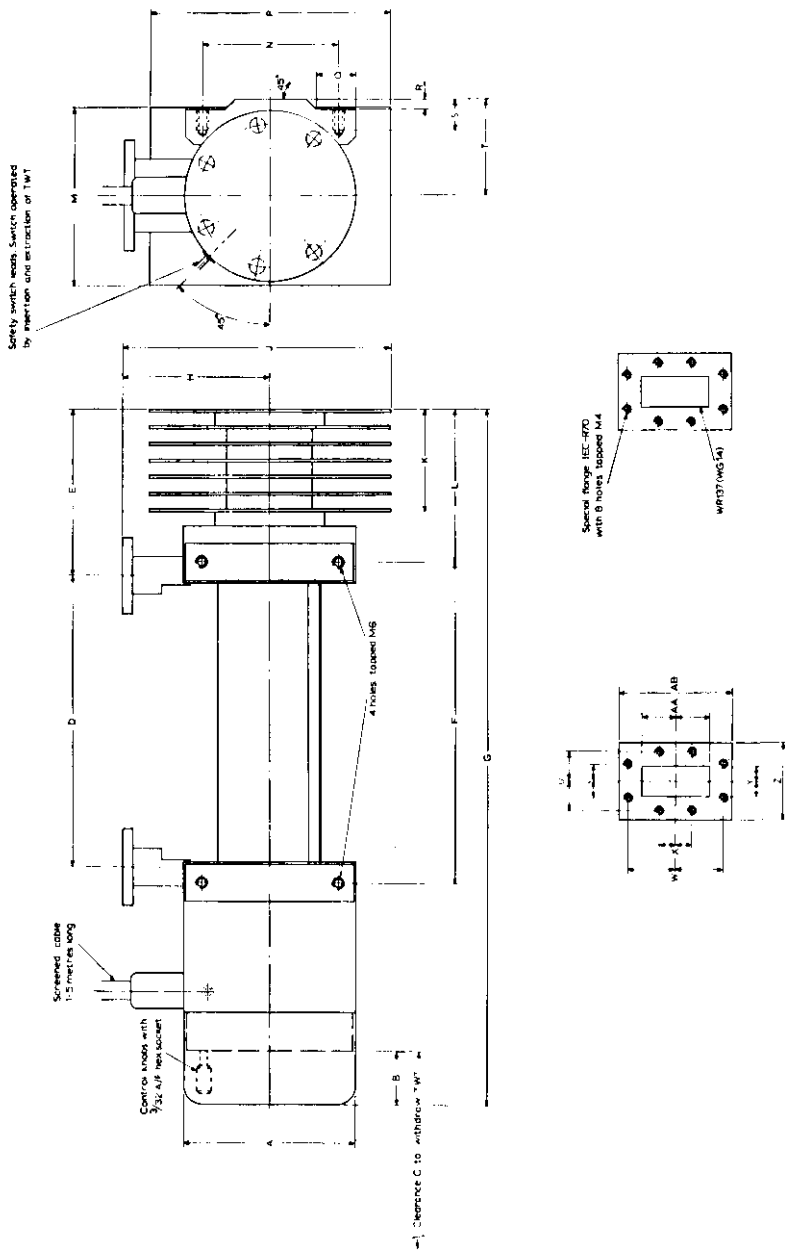

DIMENSIONS OF P6L-11 MOUNT

	Millimetres	Inches	
A	89.0	3.50	dia.
B	28.0	1.10	
C	338	13.3	
D	149.2 ± 0.1	5.874 ± 0.004	
E	85.0	3.35	
F	163.0 ± 0.2	6.417 ± 0.008	
G	356.0	14.0	
H	76.0	2.99	
J	139.0	5.47	
K	52.5	2.07	
L	78.0	3.07	
M	92.0	3.62	
N	70.0 ± 0.2	2.756 ± 0.008	
P	125.0	4.92	
Q	20.0 ± 0.5	0.79 ± 0.02	
R	5.5 ± 0.2	0.22 ± 0.008	
S	16.0	0.63	
T	50.0	1.97	
U	14.99 ± 0.05	0.590 ± 0.002	
V	8.71 ± 0.05	0.343 ± 0.002	
W	17.42 ± 0.05	0.685 ± 0.002	
X	8.18 ± 0.05	0.322 ± 0.002	
Y	7.90 ± 0.05	0.311 ± 0.002	
Z	39.0 ± 0.3	1.535 ± 0.01	
AA	24.51 ± 0.05	0.965 ± 0.002	
AB	58.0 ± 0.3	2.28 ± 0.01	

Inch dimensions derived from original millimetre dimensions

TENTATIVE DATA

QUICK REFERENCE DATA

Convection and radiation cooled forward wave amplifier suitable for use in the power output stages of wideband multi-channel microwave links.

Frequency	6	Gc/s band
Saturation Power Output	25	W
Gain	40	dB
Construction		Unpackaged

To be read in conjunction with GENERAL OPERATIONAL RECOMMENDATIONS - MICROWAVE DEVICES

TYPICAL OPERATION

As a power amplifier with the helix earthed and using a mount type 55320.

f	5.9-6.5	6.5-7.2	Gc/s
V _{collector}	1.5	1.5	kV
*V _{helix}	2.3-2.25	2.25	kV
V _{gl}	1.95	1.95	kV
I _{collector}	65	65	mA
I _{helix}	2.0	2.0	mA
I _{gl}	< 0.1	< 0.1	mA
Gain	36-38	36	dB
Power output	15-10	10	W

*Adjusted for maximum gain

ABSOLUTE MAXIMUM RATINGS

V _{collector} max.	2.0	kV
V _{helix} max.	3.0	kV
I _{helix} max.	4.0	mA
I _{cathode} max.	70	mA
V _{gl} max.	2.5	kV
I _{gl} max.	0.3	mA
P _{in (signal)} max.	100	mW



CATHODE

Indirectly heated, dispenser type

V_h (d.c. or r.m.s.)	6.3	V
I_h	800	mA
t_{h-k}	5.0	min

CHARACTERISTICS

	Min.	Typ	Max.	
Frequency band	5.9		7.2	Gc/s
**Low level gain	-		40	dB
Noise factor	-		30	dB
***Saturation power output	-		25	W
Attenuation (at $I_k = 0\text{mA}$)	60		-	dB
Cold input match v.s.w.r.	-		1.5	
Magnetic field strength at axis of mount 55320		600		Gs
**Measured at $f = 6.5\text{Gc/s}$, $I_{\text{collector}}$		65mA and V_{helix}	optimised at 2.2kV.	
***Measured at $f = 6.5\text{Gc/s}$, $I_{\text{collector}}$		65mA and V_{helix}	optimised at 2.5kV.	

COOLING

Horizontally mounted Natural by convection and radiation

Vertically mounted Natural assisted by low velocity air flow

$T_{\text{collector seal max.}}$ 200 °C

MOUNTING POSITION

Any

PHYSICAL DATA

	lb	kg
Weight of YH1030	1.76	0.8
Weight of 55320 mount	55	25



ACCESSORY

Mount Permanent magnet 55320

DETAILS OF MOUNT 55320 (see page D5)

Input and output waveguides IEC-R70 (RG-50/U, WR137, WG14)

Waveguide flanges IEC-VER70

Connections of the plug of the mount

- 1) mount, helix
- 2) free) interconnected
- 3) free)
- 4) collector
- 5) G_1
- 6) heater
- 7) heater, cathode

Mounting position Any

Note If any part of the shielding box is removed or if ferromagnetic materials are introduced into the mount, the magnetic properties of the mount may be disturbed irreversibly. Voltages should never be applied to the tube when the door is open.



B2166

All dimensions
in millimetres

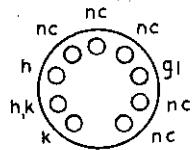
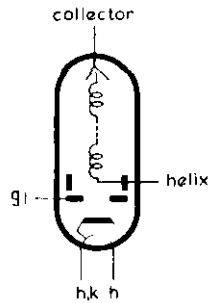
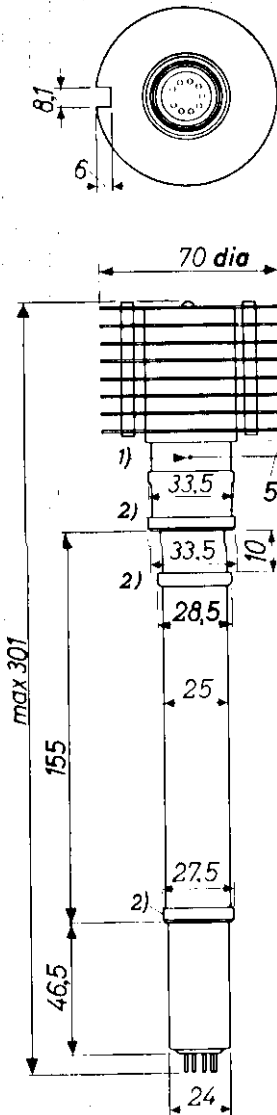

Base: B9A Noval

1) Reference point for collector temperature measurements

2) Contact rings

TRAVELLING-WAVE TUBE

YH1030

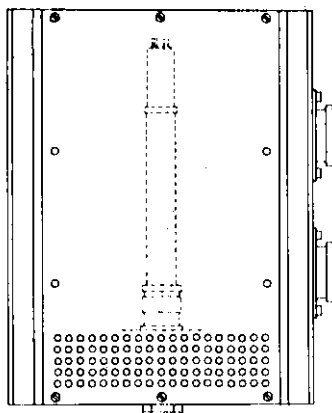
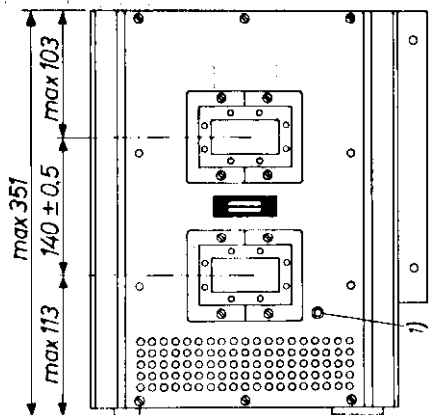
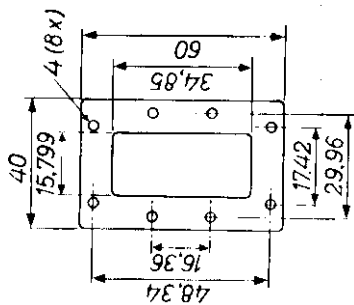
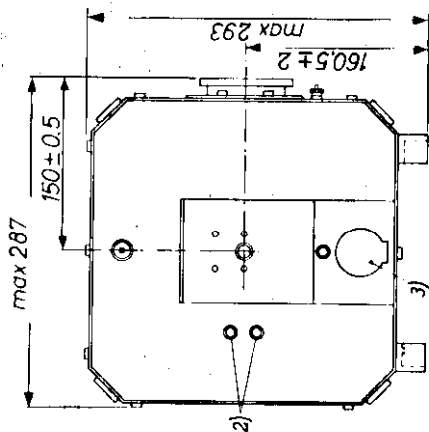

- 1) Earth connection
- 2) Focus alignment screws
- 3) Connector to power supply

Mount 55320

All dimensions
in millimetres

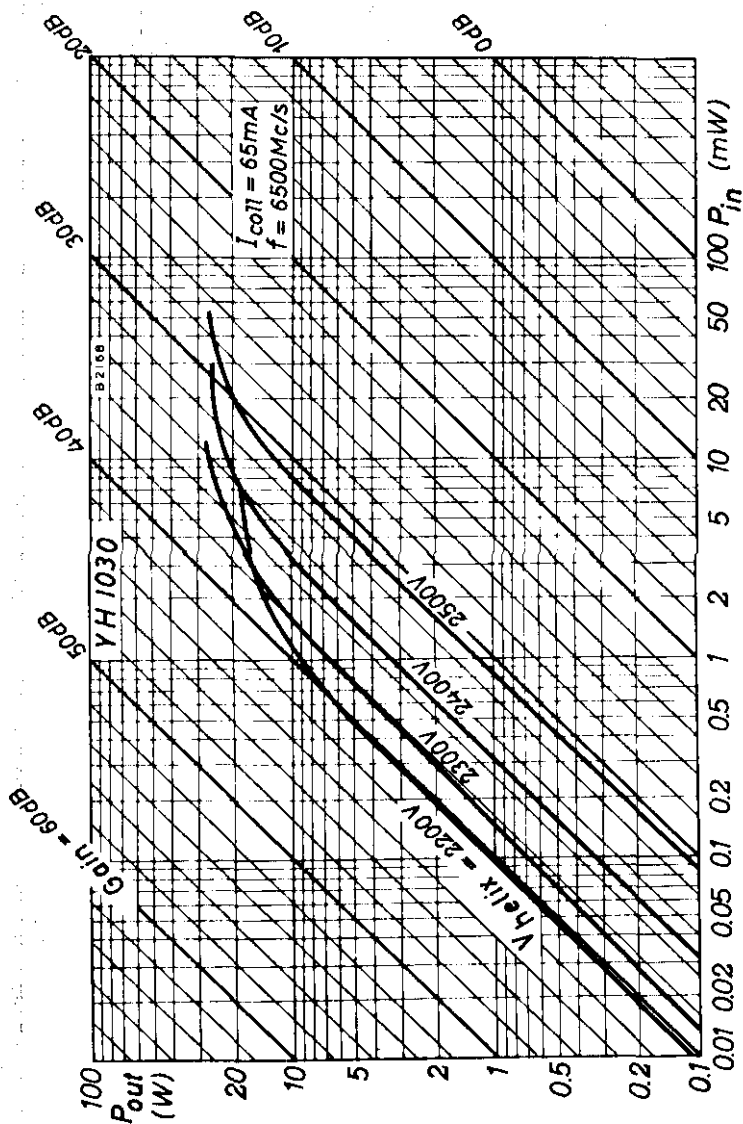

OUTPUT POWER PLOTTED AGAINST INPUT POWER
WITH HELIX VOLTAGE AS PARAMETER.

$I_{collector}$ - 65mA at $f = 6.5\text{Gc/s}$.

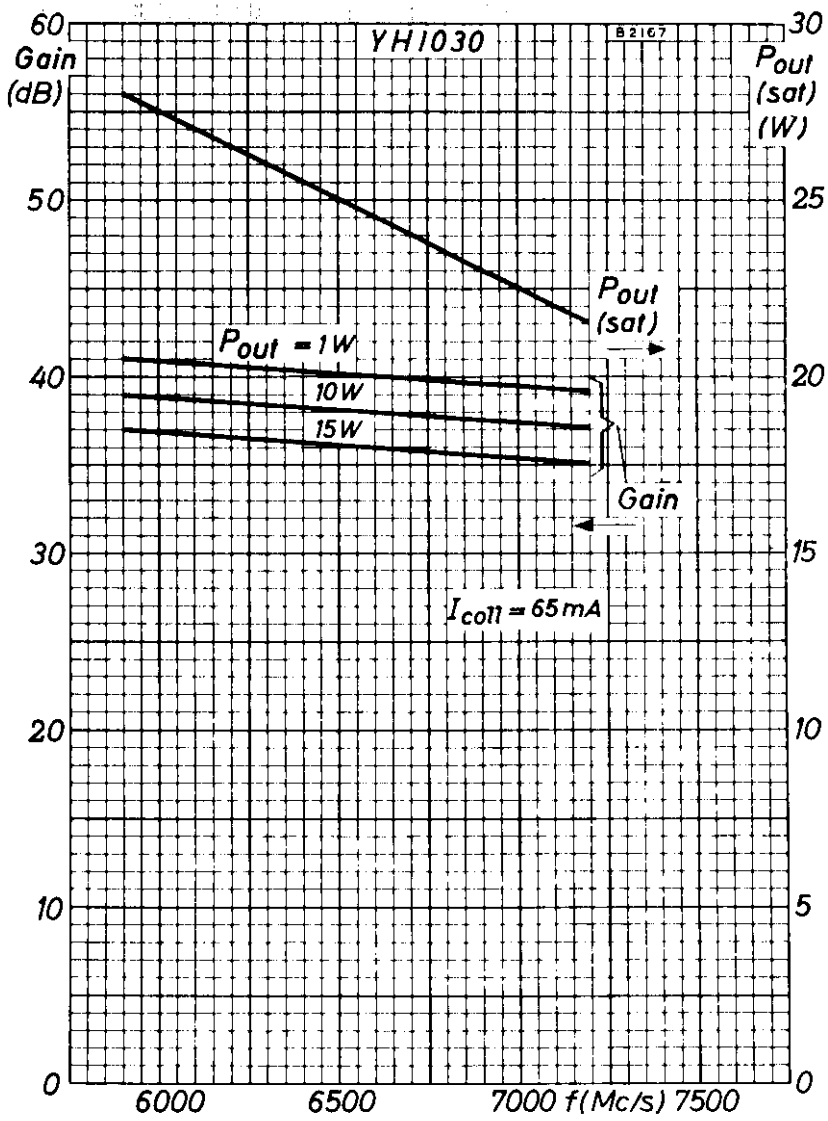

SATURATION OUTPUT POWER PLOTTED AGAINST FREQUENCY
 HELIX-TO-CATHODE VOLTAGE ADJUSTED FOR MAXIMUM OUTPUT

GAIN PLOTTED AGAINST FREQUENCY,
 HELIX-TO-CATHODE VOLTAGE ADJUSTED FOR MAXIMUM GAIN

