

ELECTROMETER PENTODE

ME1400

Pentode suitable for use in high resistance circuits for applications such as pH meters, photocell units and valve voltmeters.

HEATED

	C_{a-g1}	< 20	mpF
C_{in}		5.5	pF
C_{out}		8.5	pF

CHARACTERISTICS

Pentode connected

Measured at $V_h = 4.5V$, $V_a = V_{g2} = 45V$ and $I_a = 80\mu A$

	Min.	Av.	Max.	
I_h	150	160	170	mA
V_{g1}	-1.6	-2.0	-2.4	V
g_m	160	240	320	$\mu A/V$
I_{g2}	—	20	—	μA
I_{g1}	—	-5.0×10^{-12}	-10^{-11}	A
r_a	—	> 5.0	—	M Ω
* V_{g1} (crossover)	—	-0.8	-1.3	V

Triode connected (g_2 connected to a, g_3 connected to k)

Measured at $V_h = 4.5V$, $V_a = 45V$ and $I_a = 100\mu A$

	Min.	Av.	Max.	
I_h	150	160	170	mA
V_{g1}	-1.6	-2.0	-2.4	V
g_m	200	300	400	$\mu A/V$
I_{g1}	—	-5.0×10^{-12}	-10^{-11}	A
r_a	—	65	—	k Ω
μ	—	20	—	
* V_{g1} (crossover)	—	-0.8	-1.3	V

*'Crossover' is the point at which the polarity of the grid current is reversed.

LIMITING VALUES

V_a max.	90	V
V_{g2} max.	90	V
I_k max.	1.0	mA
V_{h-k} max.	10	V



MEI400

ELECTROMETER PENTODE

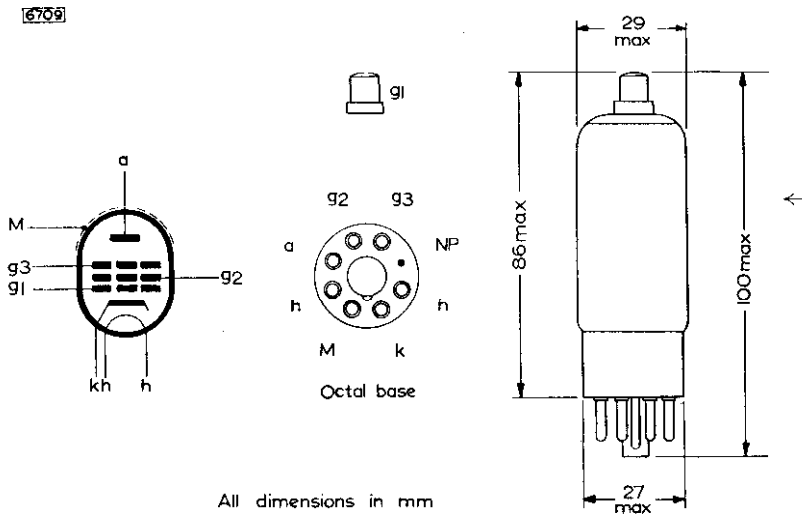

ELECTROMETER PENTODE

ME1400

Pentode suitable for use in high resistance circuits for such applications as pH meters, photocell units and valve voltmeters.

HEATER

V_h	$4.5 \pm 5\%$ V
I_h	160 mA

MOUNTING POSITION

Any

CAPACITANCES

Pentode connection

C_{h-g1}	< 0.02 pF
C_{in}	5.5 pF
C_{out}	8.5 pF

CHARACTERISTICS

Pentode connection

Measured at $V_h = 4.5V$, $V_a = V_{g2} = 45V$ and $I_a = 80\mu A$

	Min.	Av.	Max.	
I_h	150	160	170	mA
V_{g1}	-1.6	-2.0	-2.4	V
g_m	160	240	320	$\mu A/V$
I_{g2}	—	20	—	μA
$-I_{g1}$	—	5.0×10^{-12}	10^{-11}	A
r_a	—	> 5.0	—	M Ω
* $V_{g1}(\text{crossover})$	—	-0.8	-1.3	V

Triode connection (g_2 connected to a, g_3 connected to k)

Measured at $V_h = 4.5V$, $V_a = 45V$ and $I_a = 100\mu A$

	Min.	Av.	Max.	
I_h	150	160	170	mA
V_{g1}	-1.6	-2.0	-2.4	V
g_m	200	300	400	$\mu A/V$
$-I_{g1}$	—	5.0×10^{-12}	10^{-11}	A
r_a	—	65	—	k Ω
μ	—	20	—	
* $V_{g1}(\text{crossover})$	—	-0.8	-1.3	V



ME1400

ELECTROMETER PENTODE

Pentode suitable for use in high resistance circuits for such applications as pH meters, photocell units and valve voltmeters.

2579

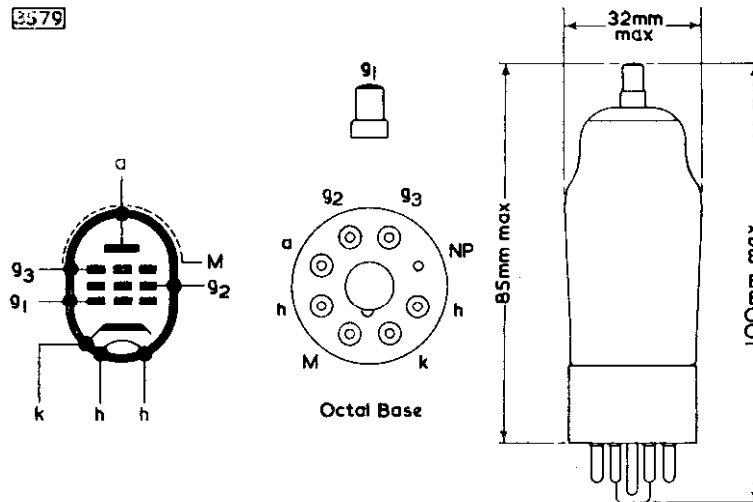

ELECTROMETER PENTODE

ME1400

Pentode suitable for use in high resistance circuits for such applications as pH meters, photocell units and valve voltmeters.

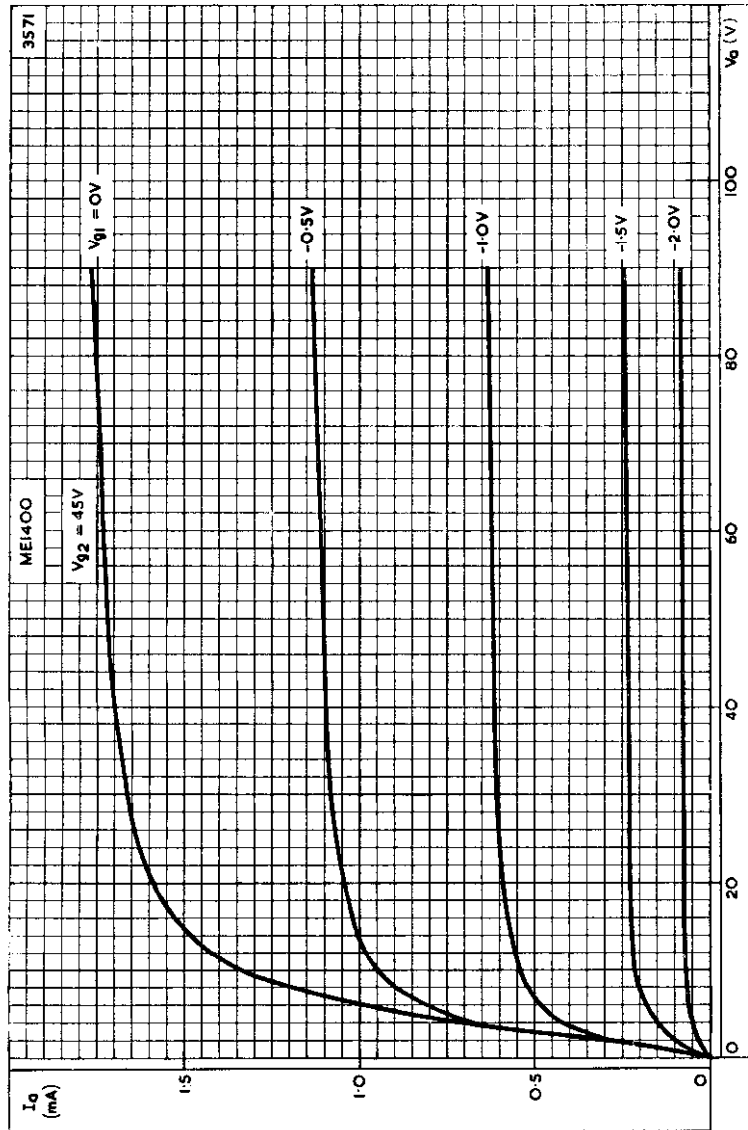

ANODE CURRENT PLOTTED AGAINST ANODE VOLTAGE WITH CONTROL-GRID VOLTAGE AS PARAMETER V_{g2}

ME1400

ELECTROMETER PENTODE

Pentode suitable for use in high resistance circuits for such applications as pH meters, photocell units and valve voltmeters.

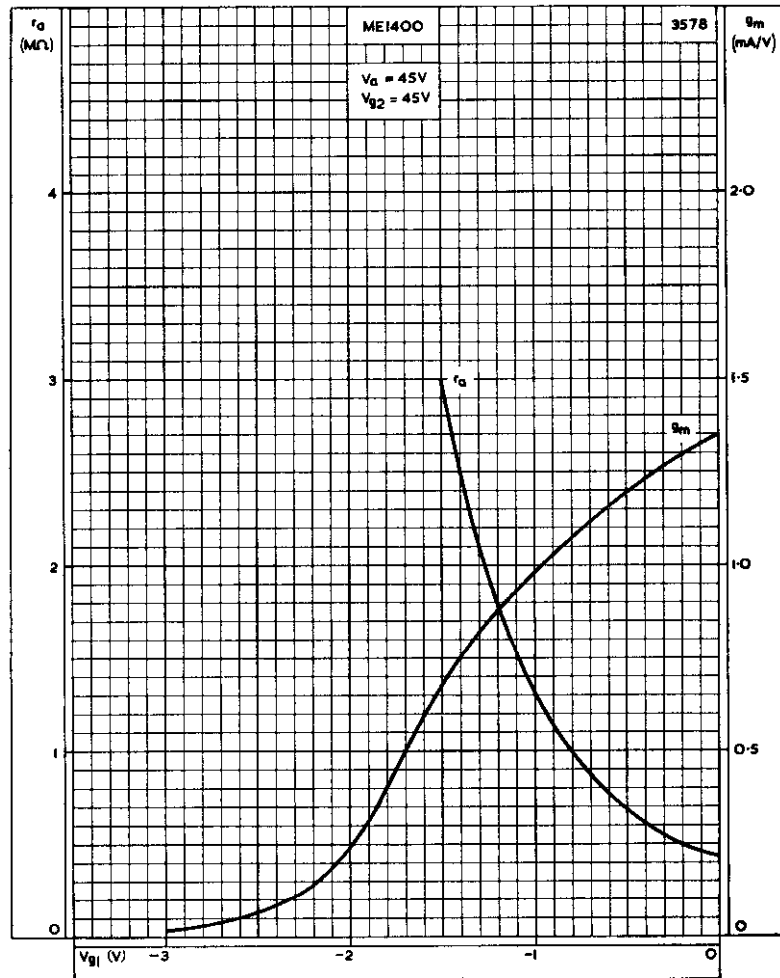

ANODE IMPEDANCE AND MUTUAL CONDUCTANCE PLOTTED AGAINST CONTROL-GRID VOLTAGE. $V_a = V_{g2} = 45V$

ELECTROMETER PENTODE

ME1400

Pentode suitable for use in high resistance circuits for such applications as pH meters, photocell units and valve voltmeters.

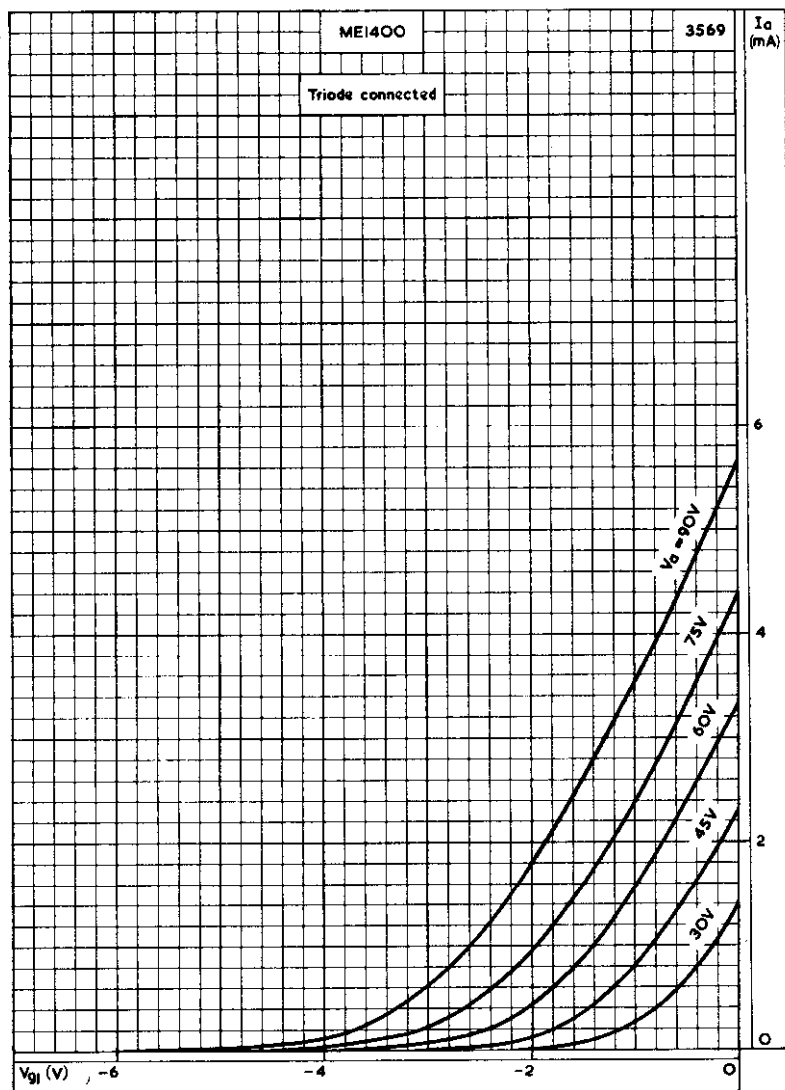

ANODE CURRENT PLOTTED AGAINST CONTROL-GRID VOLTAGE WITH ANODE VOLTAGE AS PARAMETER: TRIODE CONNECTED



ME1400

ELECTROMETER PENTODE

Pentode suitable for use in high resistance circuits for such applications as pH meters, photocell units and valve voltmeters.

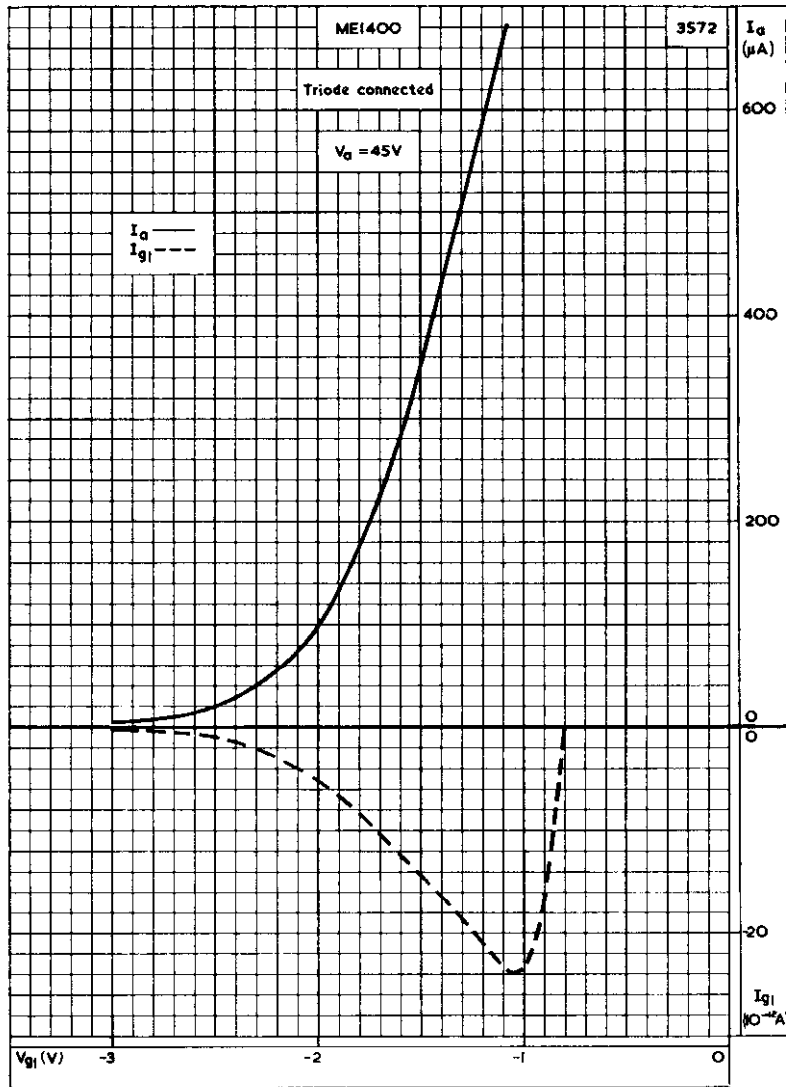

ANODE AND CONTROL-GRID CURRENT PLOTTED AGAINST CONTROL-GRID VOLTAGE. TRIODE CONNECTED. $V_a = 45V$

ELECTROMETER PENTODE

Pentode suitable for use in high resistance circuits for such application as pH meters, photocell units and valve voltmeters.

ME1400

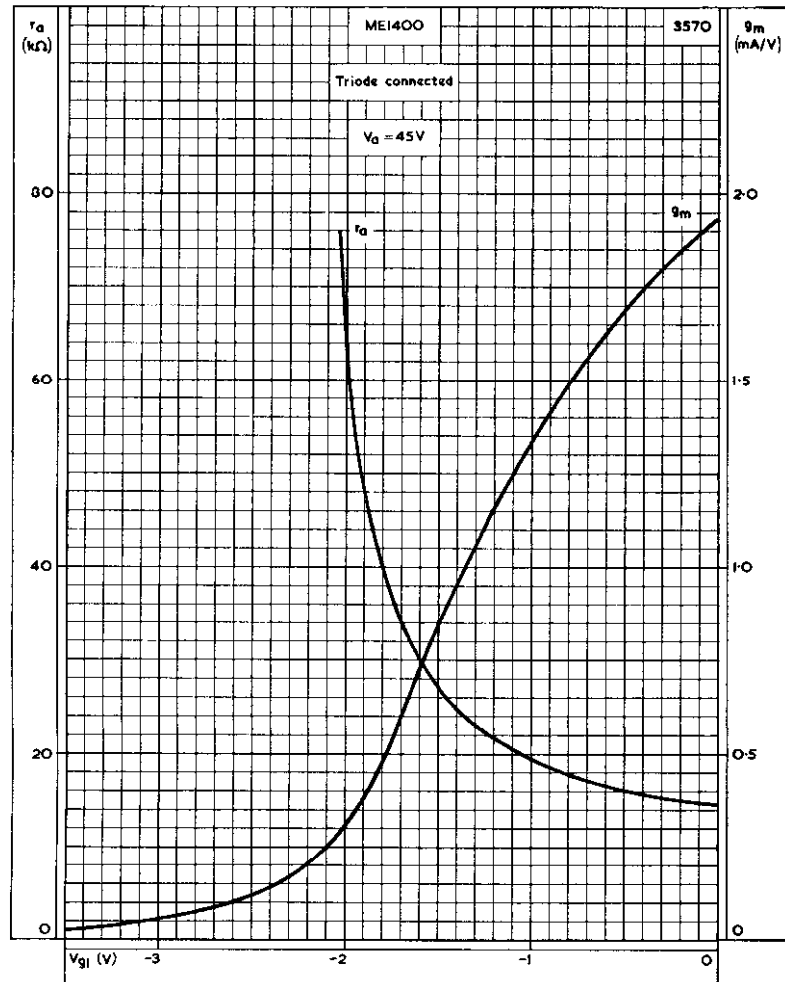

ANODE IMPEDANCE AND MUTUAL CONDUCTANCE PLOTTED AGAINST CONTROL-GRID VOLTAGE. TRIODE CONNECTED. $V_a = 45V$



SUBMINIATURE ELECTROMETER TRIODE

ME1401

Subminiature electrometer triode with a grid current of 10^{-13} A.

FILAMENT

Suitable for d.c. operation only.

V_f	1.25	V
I_f	13	mA

MOUNTING POSITION

Any

CAPACITANCES

C_{a-g}	2.0	pF
C_{g-f}	0.6	pF
C_{a-f}	0.8	pF

CHARACTERISTICS (All voltages are with respect to the negative end of the filament)

Measured at $V_f = 1.25$ V, $V_a = 9$ V, $I_a = 100$ μ A

	Min.	Av.	Max.	
V_g	-2.0	-2.5	-3.75	V
g_m	70	80	90	μ A/V
i_g	1.7	2.0	2.7	μ
* i_g	—	-8.5×10^{-14}	-12.5×10^{-14}	A
† V_g (crossover)	—	-1.3	-1.6	V
† I_a (crossover)	160	—	—	μ A

*The quoted grid current characteristics will only be obtained if the tube is operated in complete darkness.

†'Crossover' is the point at which the polarity of the grid current is reversed.

LIMITING VALUES

V_a max.	25	V
I_a max.	250	μ A
V_f limits	1.1 to 1.5	V

OPERATING NOTES

1. In order to avoid excessive drift the filament voltage must be applied before the anode voltage.
2. To avoid contamination of the glass, the valve should not be removed from its protective envelope until it is fitted into the equipment.
3. Direct soldered connections to the leads of this valve must be at least 13mm from the seal, and any bending of the valve leads must be at least 1.5mm from the seal.



ME1401

SUBMINIATURE ELECTROMETER TRIODE

Subminiature electrometer triode with a grid current of 10^{-18} A.

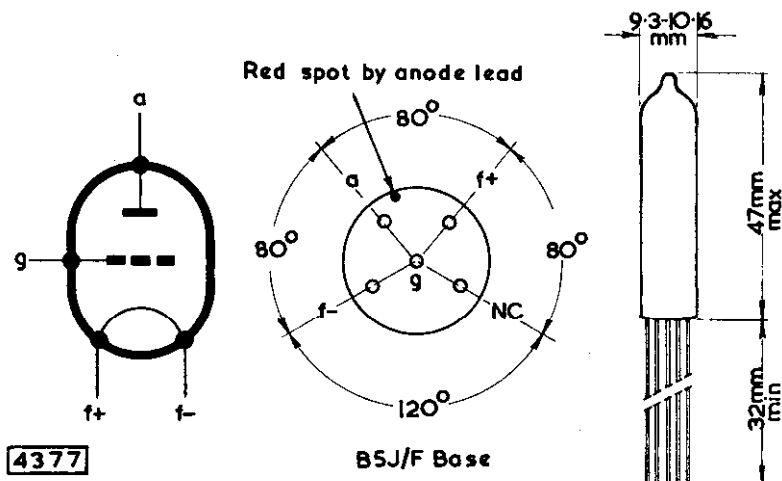

SUBMINIATURE ELECTROMETER TRIODE

ME1401

Subminiature electrometer triode with a grid current of 10^{-13} A.

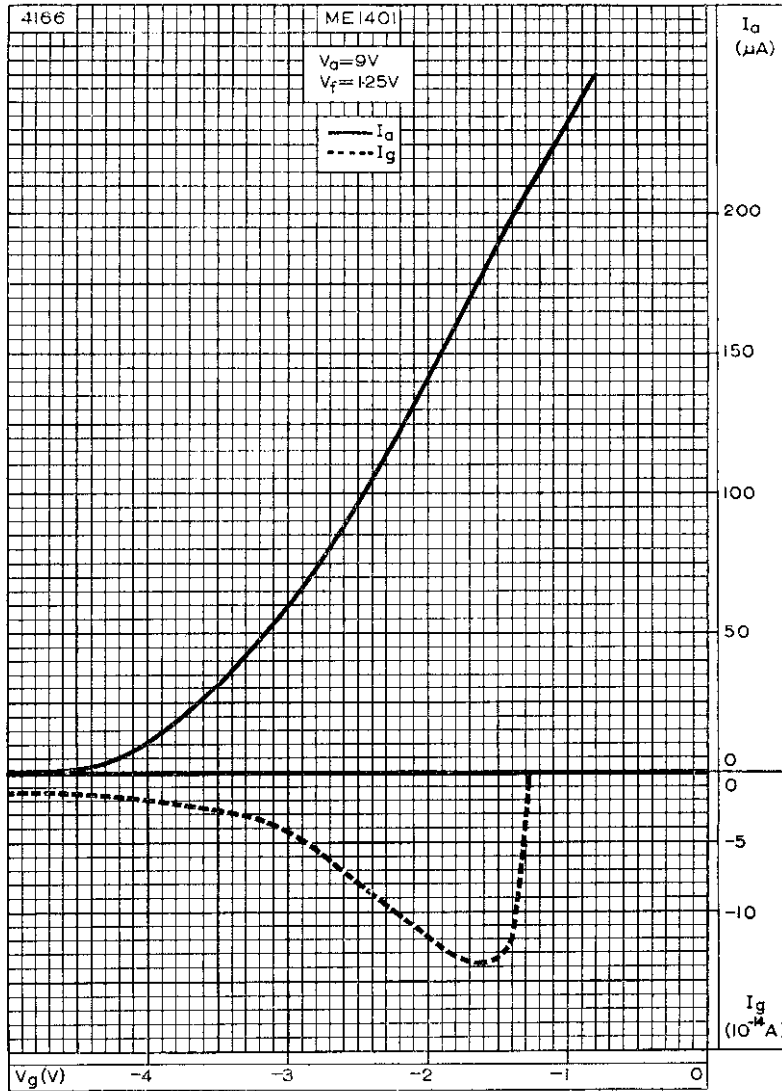

ANODE AND GRID CURRENTS PLOTTED AGAINST GRID VOLTAGE

ME1401

SUBMINIATURE ELECTROMETER TRIODE

Subminiature electrometer triode with a grid current of 10^{-12} A.

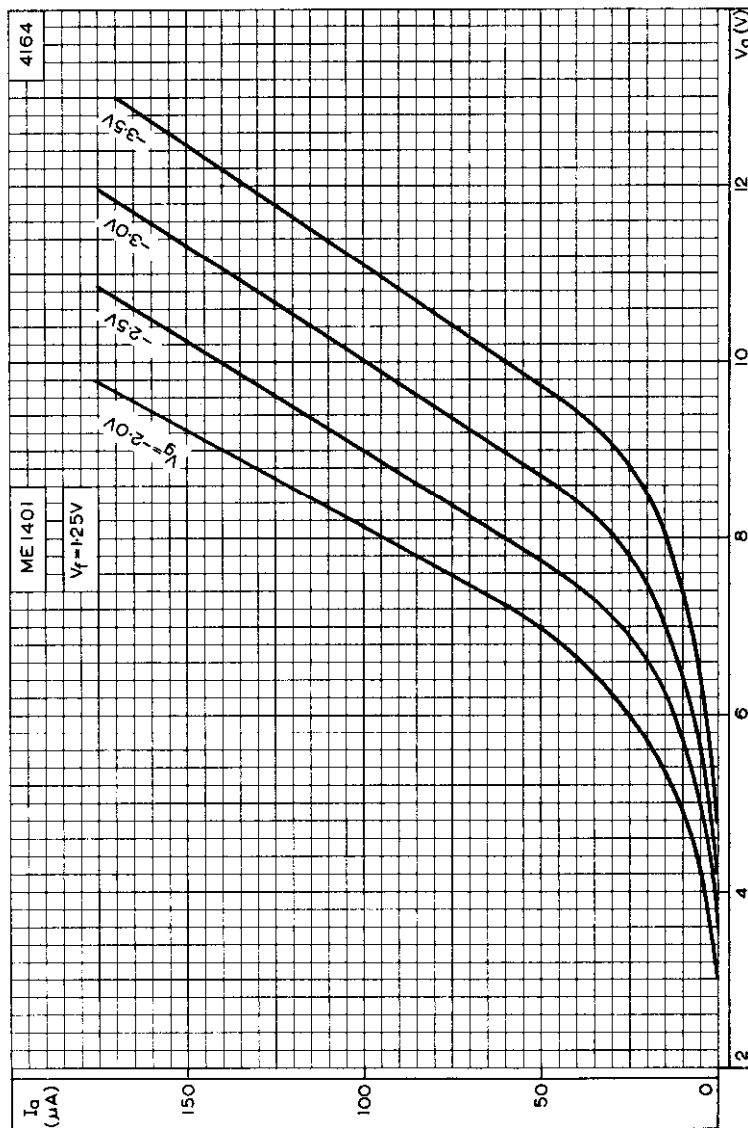

ANODE CURRENT PLOTTED AGAINST ANODE VOLTAGE WITH GRID VOLTAGE AS PARAMETER



SUBMINIATURE ELECTROMETER TETRODE

MEI402

Subminiature electrometer tetrode with a grid current
of 3×10^{-15} A.

FILAMENT

Suitable for d.c. operation only.

V_f	1.25	V
I_f	13	mA

MOUNTING POSITION

Any

CAPACITANCES

C_{a-g}	2.5	pF
C_{in}	0.3	pF
C_{out}	0.8	pF

CHARACTERISTICS (All voltages are with respect to the negative end of the filament)

Measured at $V_f = 1.25$ V, $V_a = 4.5$ V, $I_a = 20 \mu$ A, $I_{g1} = 250 \mu$ A
 g_2 is the control-grid, g_1 being used as an accelerator grid.

	Min.	Av.	Max.	
V_{g1}	2.0	3.0	4.0	V
V_{g2}	-2.0	-3.2	-4.5	V
$g_{m(g2-a)}$	10	17	24	μ A/V
$g_{m(g2-a)}$	0.7	1.2	1.4	
* I_{g2}	—	-2.5×10^{-15}	-6.0×10^{-15}	A
† V_{g2} (crossover)	—	-1.75	—	V

*The quoted grid current characteristics will only be obtained if the tube is operated in complete darkness.

†'Crossover' is the point at which the polarity of the grid current (I_{g2}) is reversed.

LIMITING VALUES

V_a max.	10	V
I_x max.	300	μ A ←
V_f limits	1.1 to 1.5	V

OPERATING NOTES

- In order to avoid excessive drift of characteristics the filament voltage must be applied before the anode voltage.
- To avoid contamination of the glass, the valve should not be removed from its protective envelope until it is fitted into the equipment.
- Direct soldered connections to the leads of the valve must be at least 13mm from the seal and any bending of the leads must be at least 1.5mm from the seal.

ME1402

SUBMINIATURE ELECTROMETER TETRODE

Subminiature electrometer tetrode with a grid current of 3×10^{-16} A.

4388

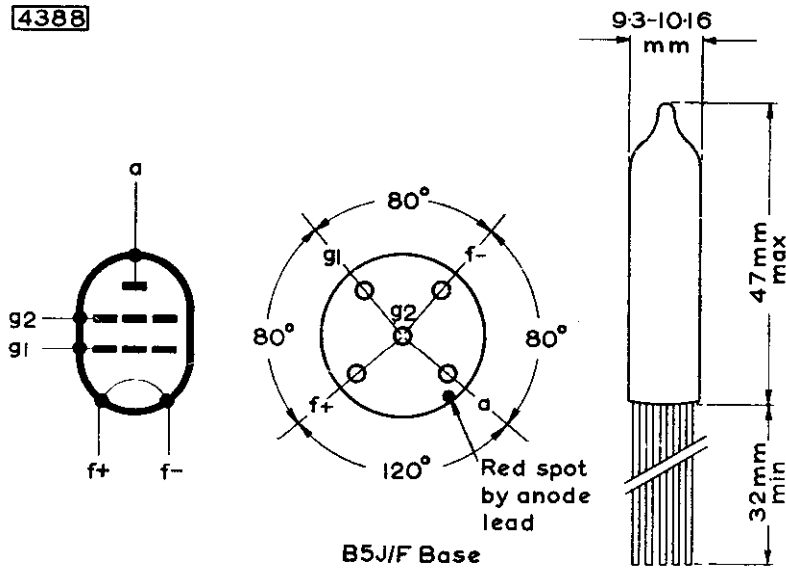

**SUBMINIATURE ELECTROMETER
TETRODE**

ME1402

Subminiature electrometer tetrode with a grid current of 3×10^{-15} A.

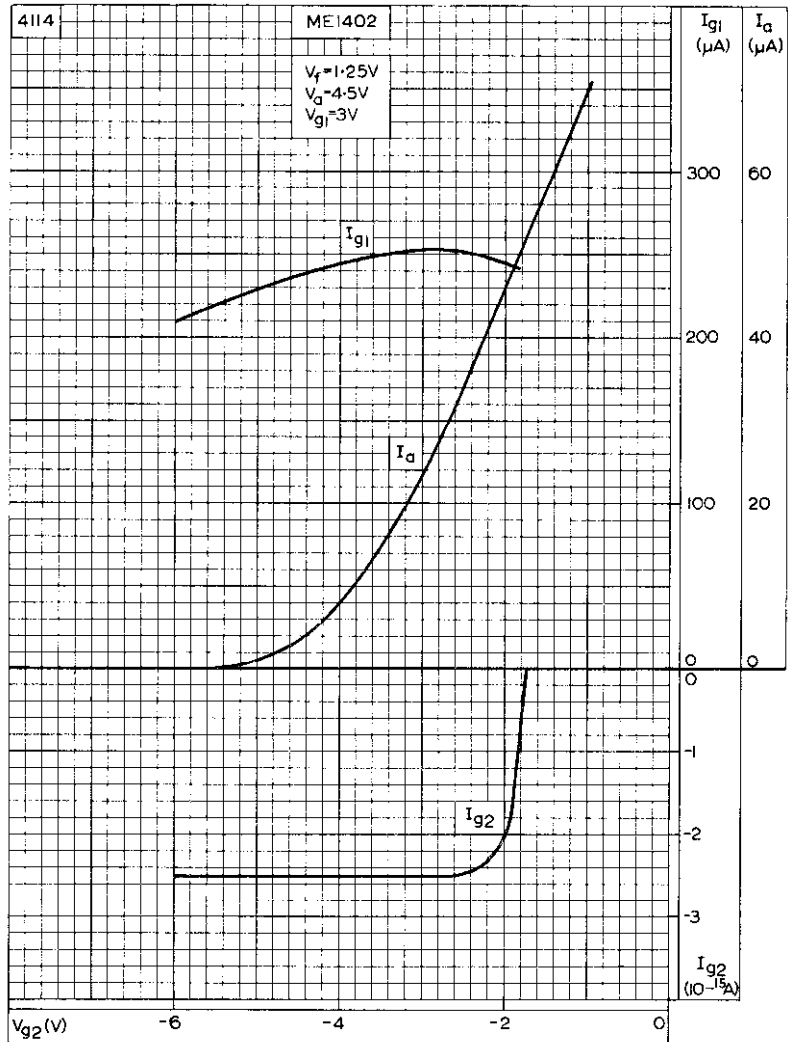

ANODE, ACCELERATOR GRID (g_1) AND CONTROL-GRID (g_2) CURRENTS
PLOTTED AGAINST CONTROL-GRID VOLTAGE

ME1402

SUBMINIATURE ELECTROMETER TETRODE

Subminiature electrometer tetrode with a grid current of 3×10^{-15} A.

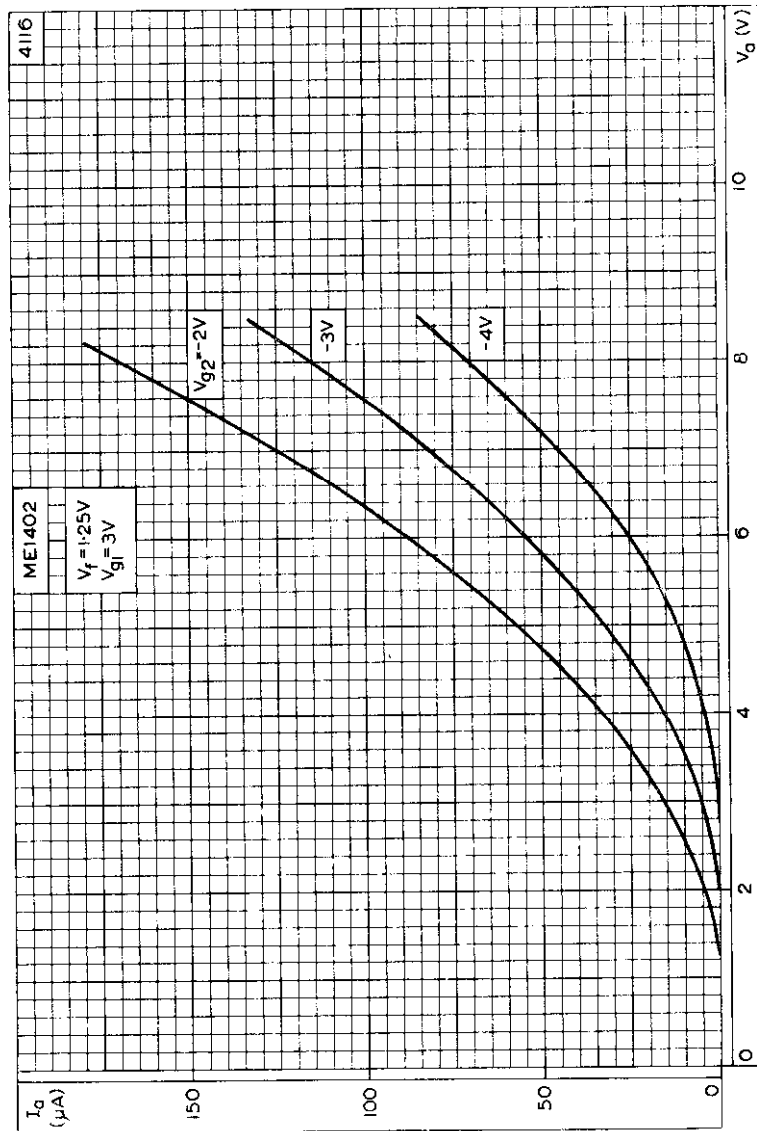

ANODE CURRENT PLOTTED AGAINST ANODE VOLTAGE WITH CONTROL-GRID (g_2) VOLTAGE AS PARAMETER AT ACCELERATOR GRID (g_1) VOLTAGE OF 3V



**SUBMINIATURE ELECTROMETER
TETRODE**

ME1402

Subminiature electrometer tetrode with a grid current
of $3 \times 10^{-15}A$.

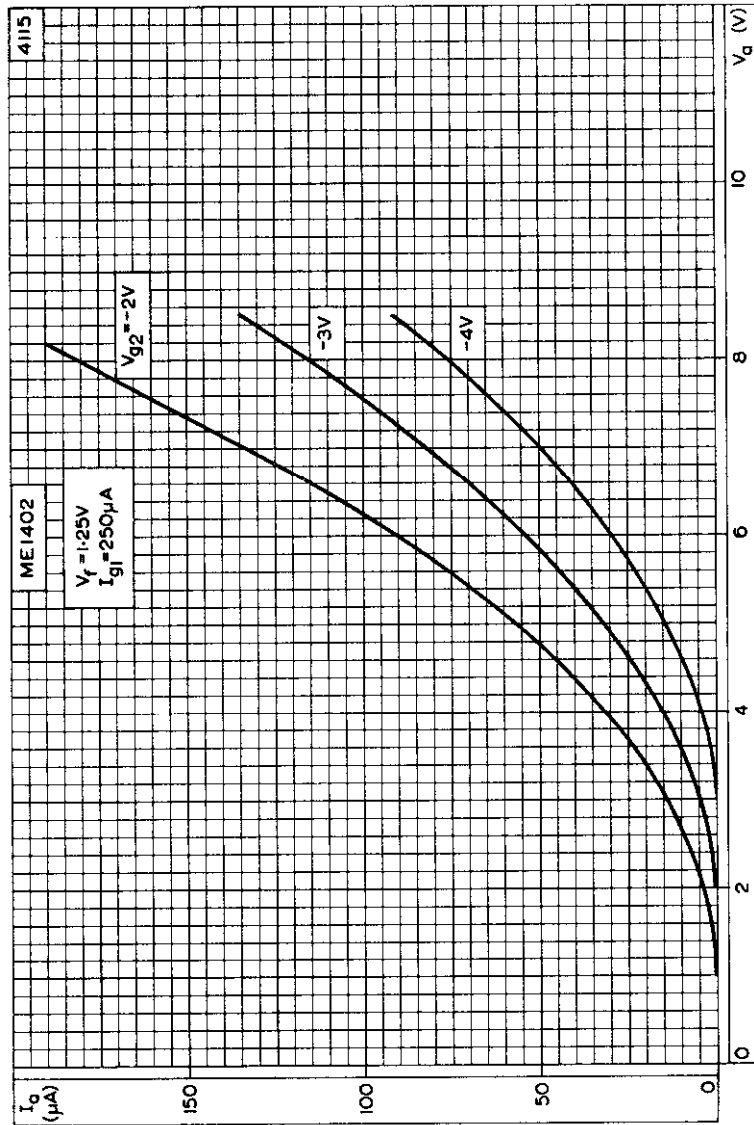

ANODE CURRENT PLOTTED AGAINST ANODE VOLTAGE WITH
CONTROL-GRID (g_2) VOLTAGE AS PARAMETER AT ACCELERATOR
GRID (g_1) CURRENT OF $250\mu A$



Vertical line on the left side of the page.



Horizontal line at the bottom of the page.

SUBMINIATURE ELECTROMETER PENTODE

MEI403

Subminiature electrometer pentode with a grid current
of 3×10^{-15} A.

FILAMENT

Suitable for d.c. operation only

V_f	1.25	V
I_f	8.2	mA

MOUNTING POSITION

Any

CAPACITANCES

C_{a-g1}	0.2	pF
C_{in}	3.0	pF
C_{out}	4.0	pF

CHARACTERISTICS (All voltages are with respect to the negative end of the filament)

Measured at $V_f = 1.25$ V, $V_a = 10$ V, $I_a = 5.0 \mu$ A, $V_{g1} = -2.5$ V

	Min.	Av.	Max.	
V_{g2}	5.0	6.5	7.5	V
g_m	8.0	10.5	15	μ A/V
r_a	—	10.5	—	M Ω
$I_{g1}^{(g1-a)}$	80	110	—	μ A
* I_{g1}	—	-3.0×10^{-15}	-8.0×10^{-15}	A
I_{g2}	1.5	2.2	3.0	μ A
† V_{g1} (crossover)	—	-1.15	—	V

*The quoted grid current characteristics will only be obtained if the tube is operated in complete darkness.

†'Crossover' is the point at which the polarity of the grid current is reversed (measured at $V_f = 1.25$ V, $V_a = 10$ V, $V_{g2} =$ the value which gives $I_a = 5 \mu$ A when $V_{g1} = -2.5$ V)

LIMITING VALUES

V_a max.	45	V
V_{g2} max.	45	V
I_k max.	180	μ A
V_f limits	1.1 to 1.5	V

OPERATING NOTES

1. In order to avoid excessive drift of characteristics the filament voltage must be applied before the anode voltage.
2. To avoid contamination of the glass, the valve should not be removed from its protective envelope until it is fitted into the equipment.
3. Direct soldered connections to the leads of the valve must be at least 13mm from the seal and any bending of the valve leads must be at least 1.5mm from the seal.



ME1403

SUBMINIATURE ELECTROMETER PENTODE

5525

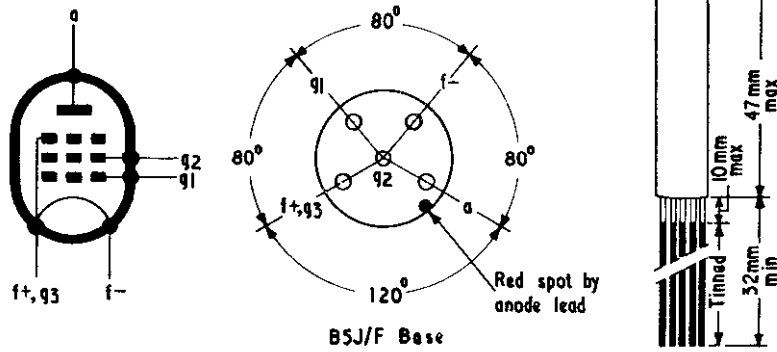

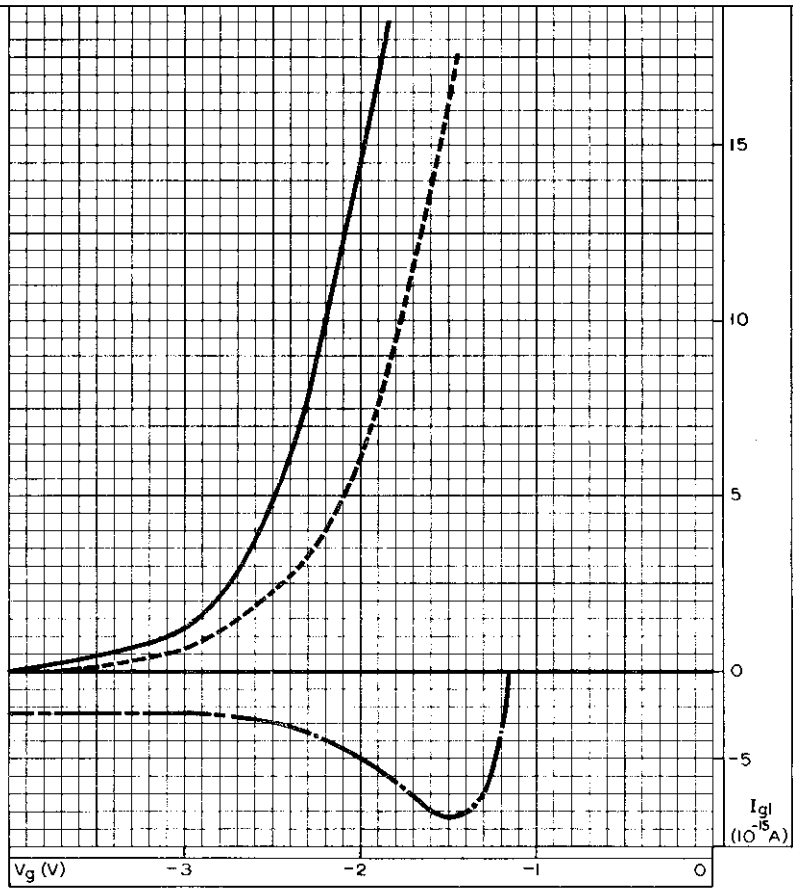

ANODE, SCREEN-GRID AND CONTROL-GRID CURRENTS PLOTTED AGAINST CONTROL-GRID VOLTAGE. $V_a = 10V$, $V_{g2} = 6.5V$



ME1403

SUBMINIATURE ELECTROMETER PENTODE

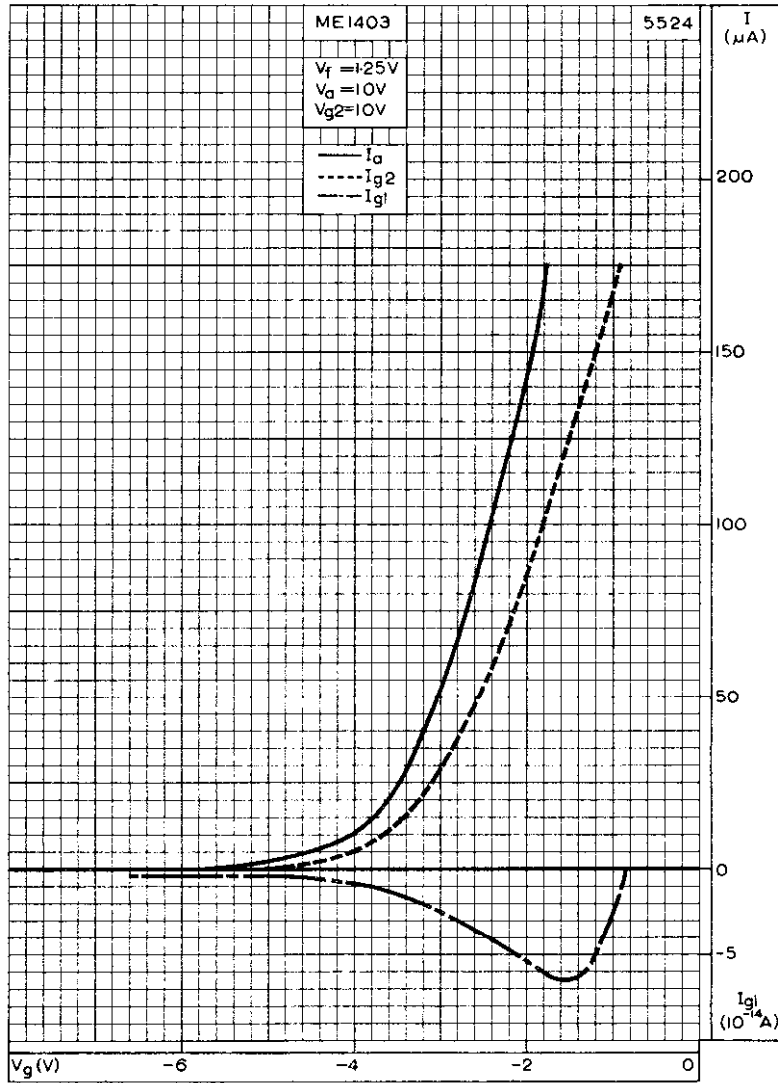

ANODE, SCREEN-GRID AND CONTROL-GRID CURRENTS PLOTTED
AGAINST CONTROL-GRID VOLTAGE. $V_a = 10V$, $V_{g2} = 10V$

SUBMINIATURE ELECTROMETER
PENTODE

MEI403

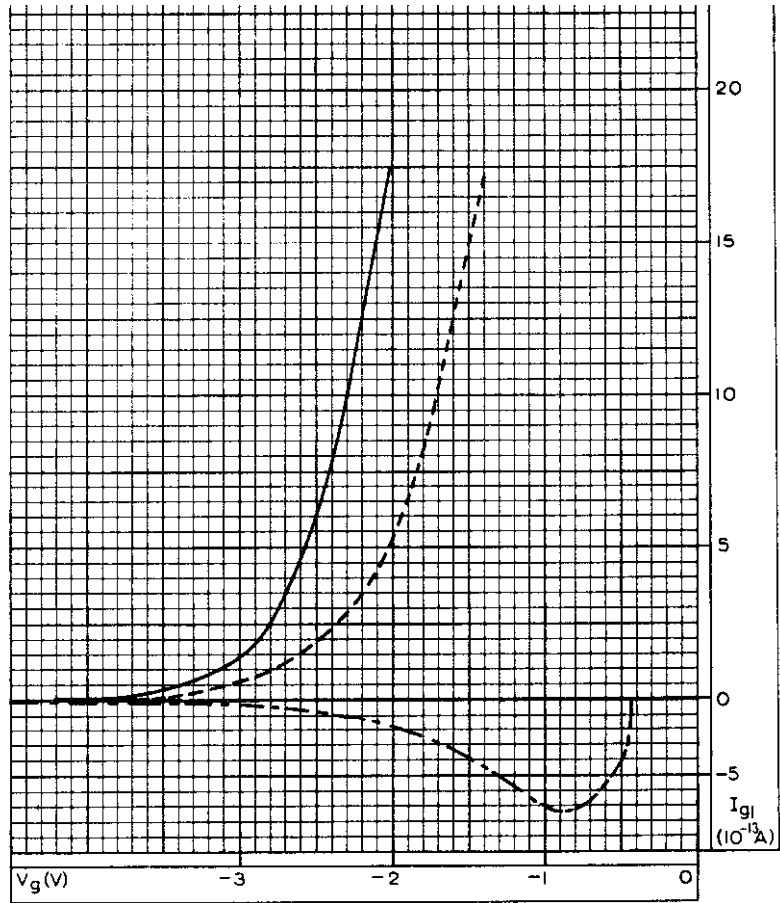

ANODE, SCREEN-GRID AND CONTROL-GRID CURRENTS PLOTTED
AGAINST CONTROL-GRID VOLTAGE. $V_a = 45V$, $V_{g2} = 6.5V$

ME1403

SUBMINIATURE ELECTROMETER PENTODE

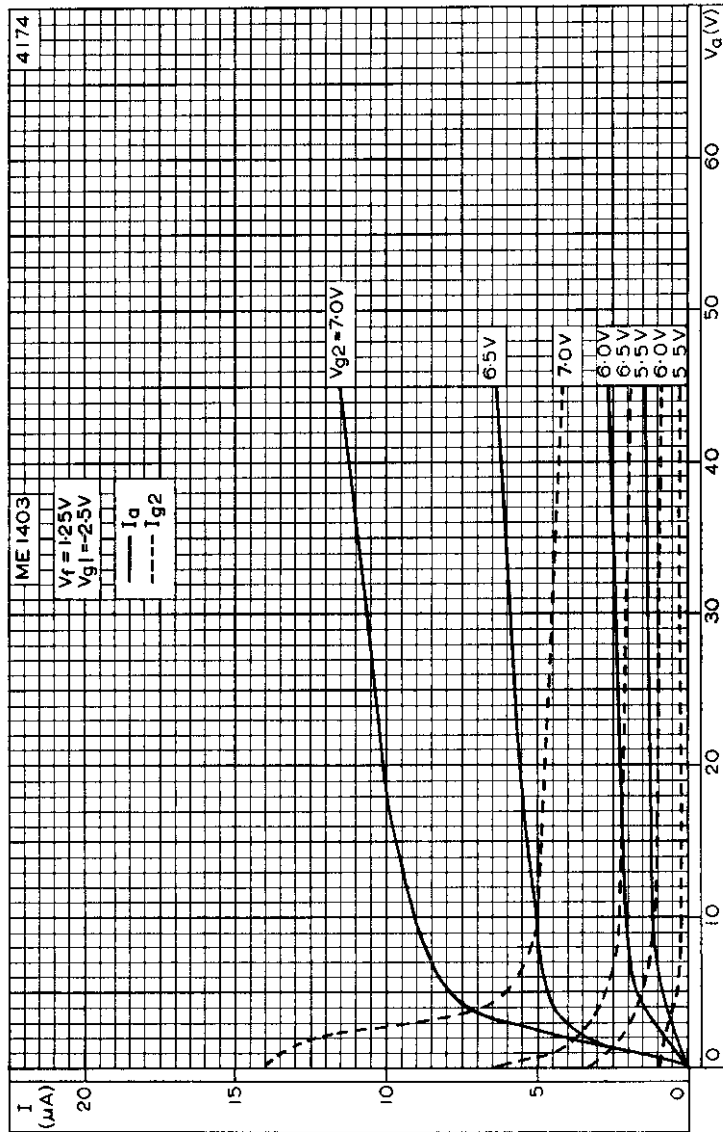

ANODE AND SCREEN-GRID CURRENTS PLOTTED AGAINST ANODE VOLTAGE WITH SCREEN-GRID VOLTAGE AS PARAMETER

SUBMINIATURE ELECTROMETER
PENTODE

ME1403

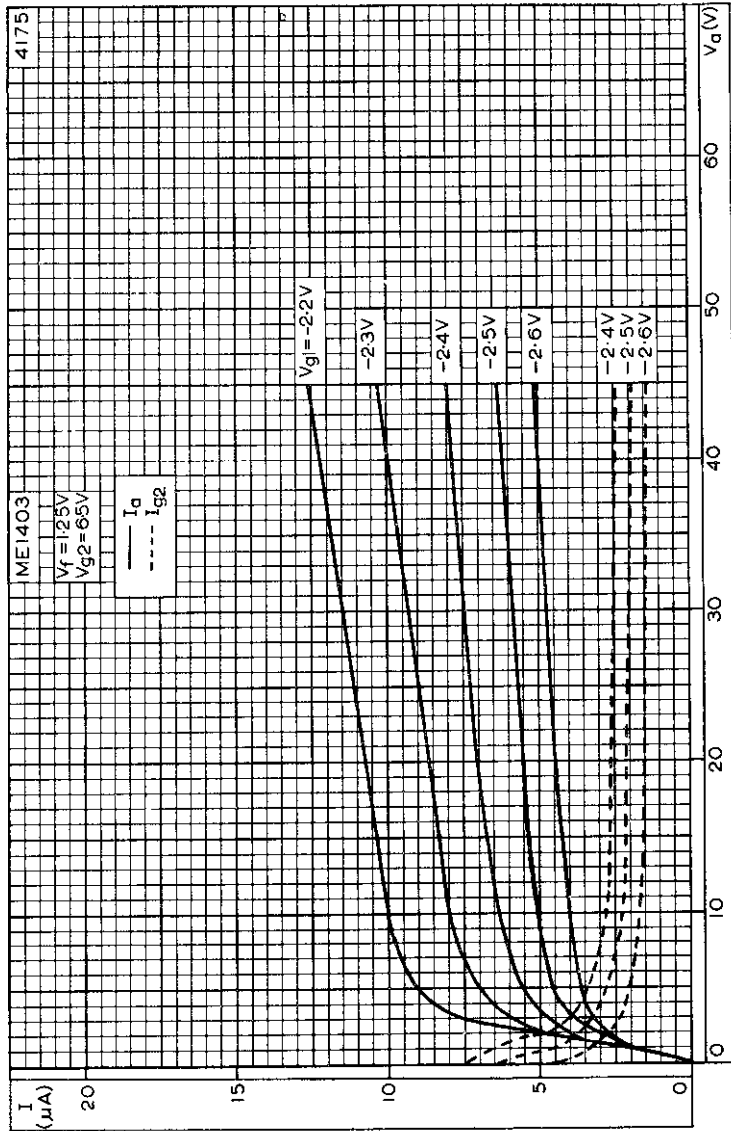

ANODE AND SCREEN-GRID CURRENTS PLOTTED AGAINST ANODE VOLTAGE WITH CONTROL-GRID VOLTAGE AS PARAMETER. $V_{g2} = 6.5V$



ME1403

SUBMINIATURE ELECTROMETER PENTODE

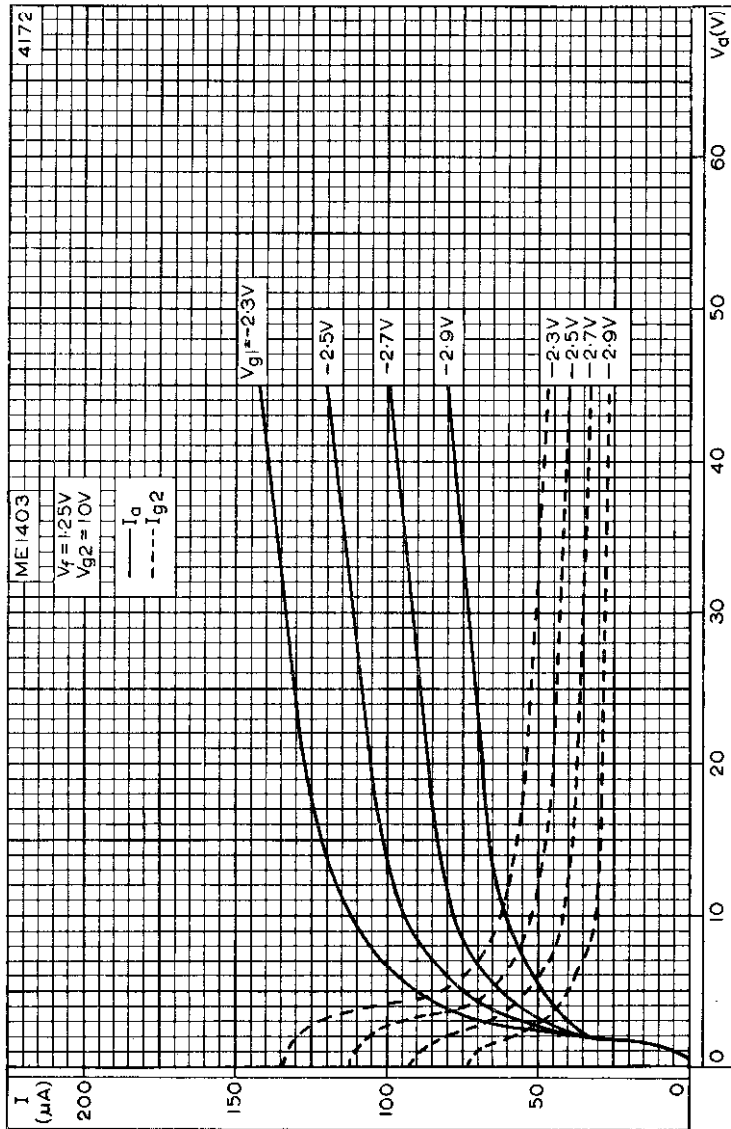

ANODE AND SCREEN-GRID CURRENTS PLOTTED AGAINST ANODE VOLTAGE WITH CONTROL-GRID VOLTAGE AS PARAMETER. $V_{g2} = 10V$

SUBMINIATURE ELECTROMETER TRIODE

MEI404

Subminiature electrometer triode for linear and logarithmic use with a controlled logarithmic relationship between positive grid current and anode current, and a grid current of 2×10^{-13} A.

FILAMENT

Suitable for d.c. operation only

V_f	1.25	V
I_f	14	mA

CAPACITANCES

C_{a-g}	2.0	pF
C_{in}	0.5	pF
	10^9	μF

μ	1.6	2.0	2.7	
I_g	—	-1.6×10^{-13}	-10×10^{-13}	A
$\dagger V_g$ (crossover)	—	-1.4	-1.7	V
$\dagger I_a$ (crossover)	145	—	—	μA

\dagger 'Crossover', measured at $V_a = 9.0V$, is the point at which the polarity of the grid current is reversed.

LIMITING VALUES

V_a max.	25	V
I_a max.	250	μA
V_f limits	1.1 to 1.5	V

Notes for operation with logarithmic characteristic

This valve has a controlled linear relationship between the anode current and the logarithm of the positive grid current. This relationship holds good over a range of at least three decades of positive grid current i.e. from $3 \times 10^{-13}A$ to $3 \times 10^{-9}A$. Conditions can be established such that this change in grid current always produces a fall in anode current of $50\mu A$.

With a positive grid current of $3 \times 10^{-9}A$, the anode voltage should be set to some value (nominal 4.4V) such that when the grid current is reduced to $3 \times 10^{-13}A$ the anode current falls by $50\mu A$. It will be found that the anode voltage lies in the approx. range 3 to 6V, whilst the initial anode current is in the range 65 to $100\mu A$.



MEI404 SUBMINIATURE ELECTROMETER TRIODE

OPERATING NOTES

1. In order to avoid excessive drift of characteristics the filament voltage must be applied before the anode voltage.
2. To avoid contamination of the glass the valve should not be removed from its protective envelope until it is fitted into the equipment. Great care should be taken not to handle the valve within 13mm of the base.
3. Direct soldered connections to the leads of the valve must be at least 13mm from the seal and any bending of the leads must be 1.5mm from the seal.
4. To prevent photoemission from the grid, the valve should be operated in darkness or at a low ambient light level.

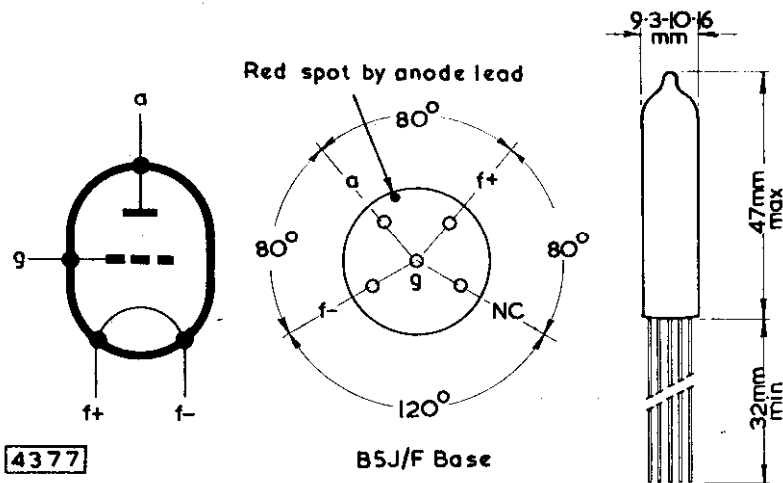

SUBMINIATURE ELECTROMETER
TRIODE

ME1404

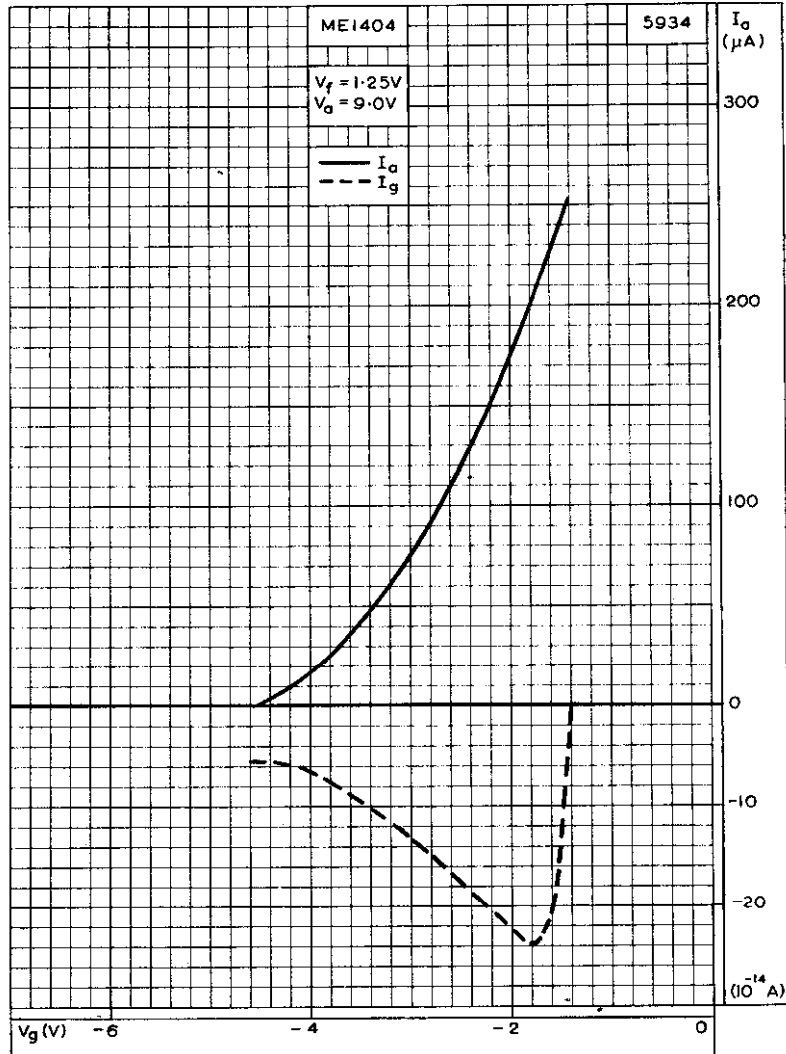

ANODE AND GRID CURRENTS PLOTTED AGAINST GRID VOLTAGE

ME1404

SUBMINIATURE ELECTROMETER TRIODE

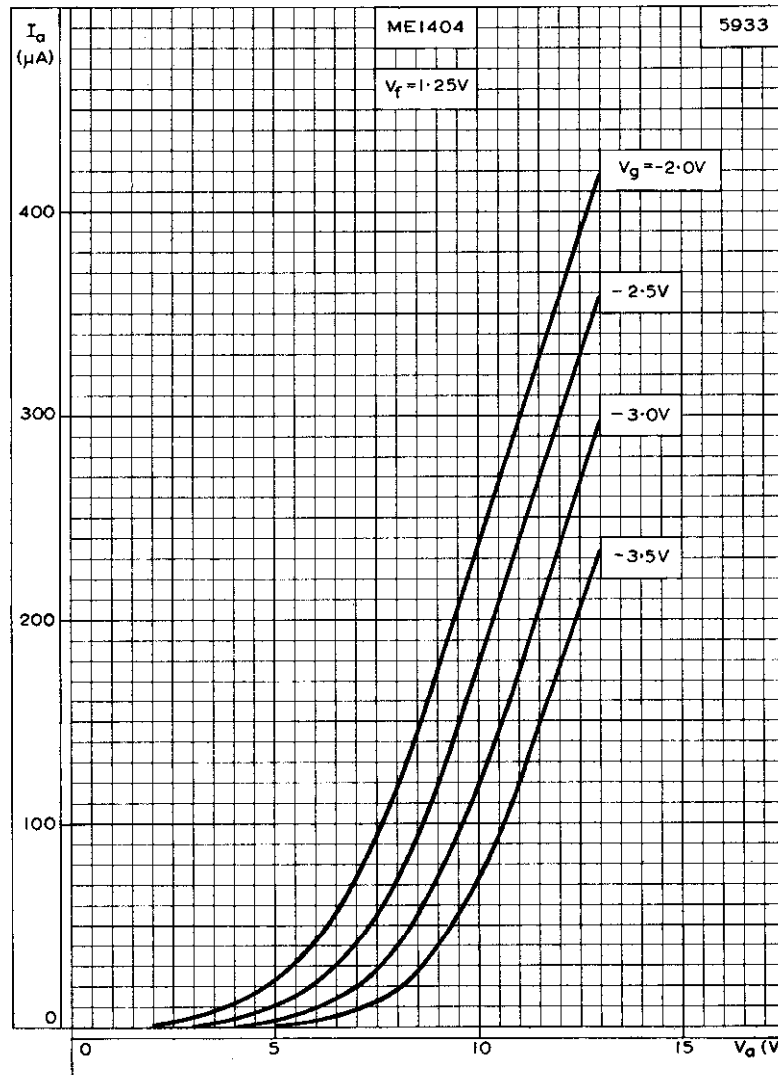

ANODE CURRENT PLOTTED AGAINST ANODE VOLTAGE WITH GRID VOLTAGE AS PARAMETER

SUBMINIATURE ELECTROMETER PENTODE

ME1406

Low cost subminiature electrometer pentode with a grid current of 3×10^{-14} A ←

FILAMENT

Suitable for d.c. operation only

V_f	1.25	V
I_f	8.2	mA

MOUNTING POSITION Any

	Min.	Av.	Max.	
V_{g2}	5.0	6.5	7.5	V
g_m	8.0	10.5	15	$\mu A/V$
r_a	-	10.5	-	$M\Omega$
μ_{g1-a}	80	110	-	
* I_{g1}	-	-3×10^{-14}	-5×10^{-14}	A ←
I_{g2}	1.5	2.2	3.0	μA
** V_{g1} (crossover)	-	-1.0	-	V ←

*The quoted grid current characteristics will only be obtained if the tube is operated in complete darkness.

**'Crossover' is the point at which the polarity of the grid current is reversed (measured at $V_f = 1.25V$, $V_a = 10V$, V_{g2} = the value which gives $I_a = 5\mu A$ when $V_{g1} = -2.5V$).

RATINGS (ABSOLUTE MAXIMUM SYSTEM)

V_a max.	45	V
V_{g2} max.	45	V
I_k max.	180	μA
V_f max.	1.5	V
V_f min.	1.1	V

OPERATING NOTES

1. In order to avoid excessive drift of characteristics the filament voltage must be applied before the anode voltage.
2. To avoid contamination of the glass, the valve should not be removed from its protective envelope until it is fitted into the equipment.
3. Direct soldered connections to the leads of the valve must be at least 13mm from the seals and any bending of the leads must be at least 1.5mm from the seals.

Outline drawing
ME1406

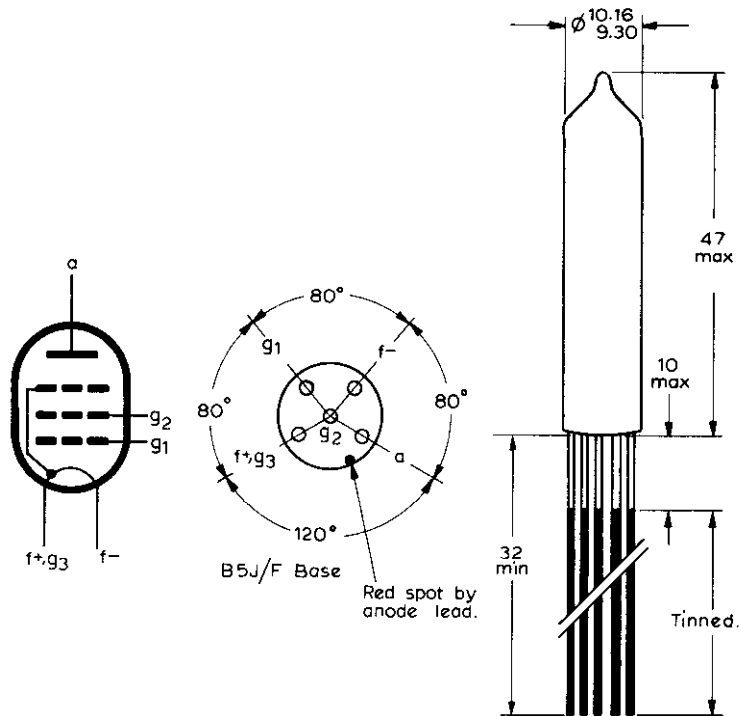

All dimensions in mm

**SUBMINIATURE
ELECTROMETER PENTODE**

ME1406

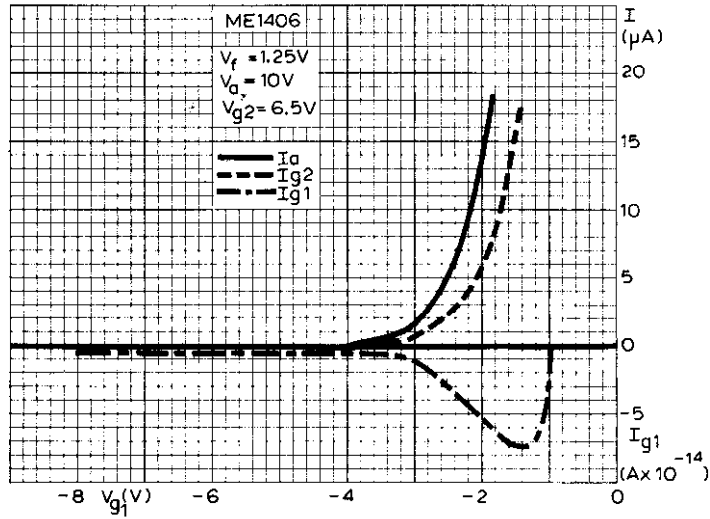

ANODE, SCREEN-GRID AND CONTROL-GRID CURRENTS PLOTTED AGAINST CONTROL-GRID VOLTAGE. $V_a = 10V$, $V_{g2} = 6.5V$

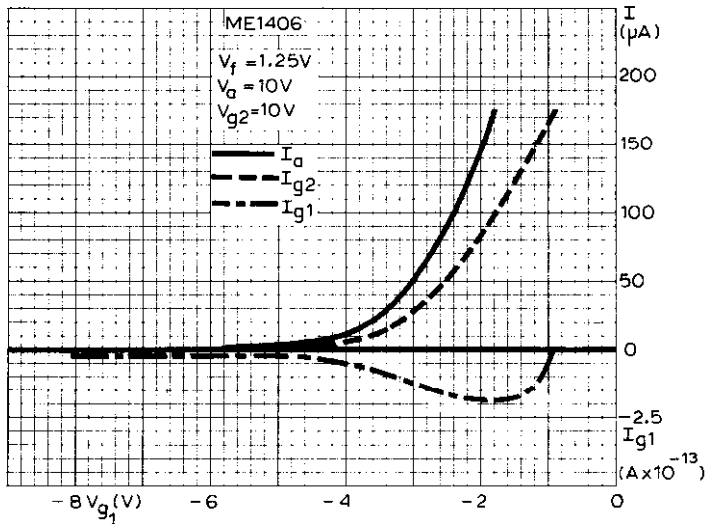

ANODE, SCREEN-GRID AND CONTROL-GRID CURRENTS PLOTTED AGAINST CONTROL-GRID VOLTAGE. $V_a = 10V$, $V_{g2} = 10V$



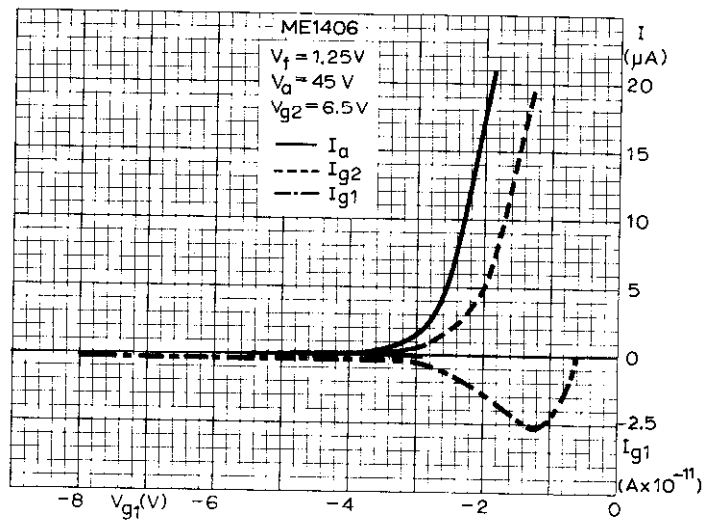

ANODE, SCREEN-GRID AND CONTROL-GRID CURRENTS PLOTTED AGAINST CONTROL-GRID VOLTAGE. $V_a = 45V$, $V_{g2} = 6.5V$

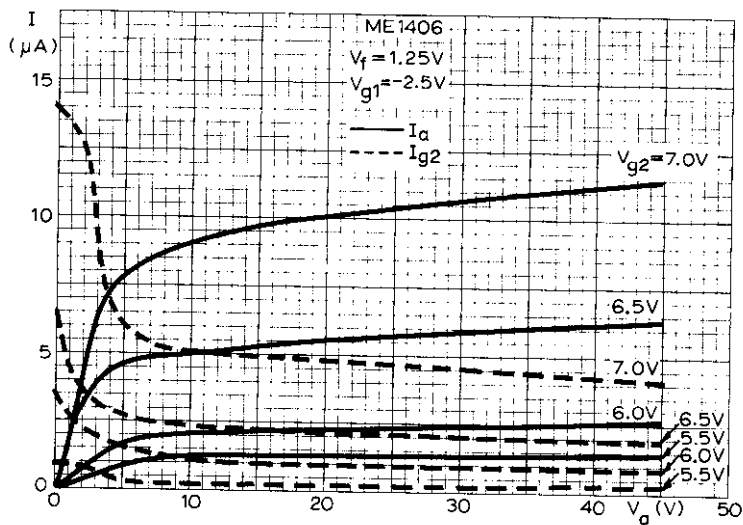

ANODE AND SCREEN-GRID CURRENT PLOTTED AGAINST ANODE VOLTAGE WITH SCREEN-GRID VOLTAGE AS PARAMETER



**SUBMINIATURE
ELECTROMETER PENTODE**

ME1406

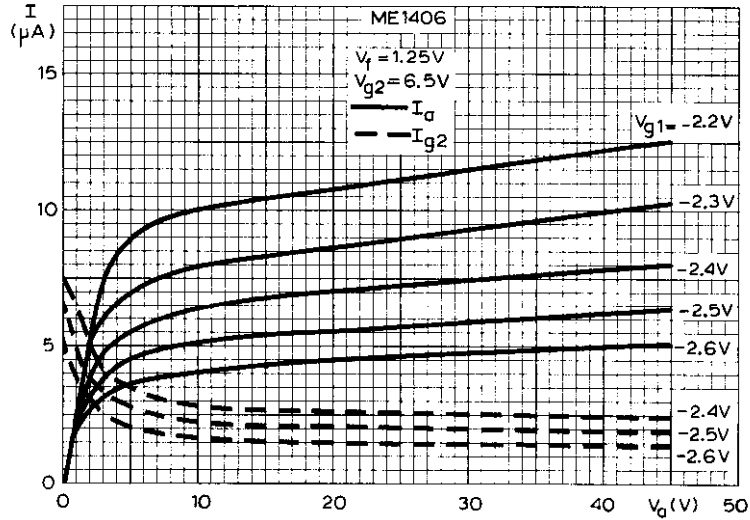

ANODE AND SCREEN-GRID CURRENT PLOTTED AGAINST ANODE VOLTAGE WITH CONTROL-GRID VOLTAGE AS PARAMETER. $V_{g2} = 6.5V$

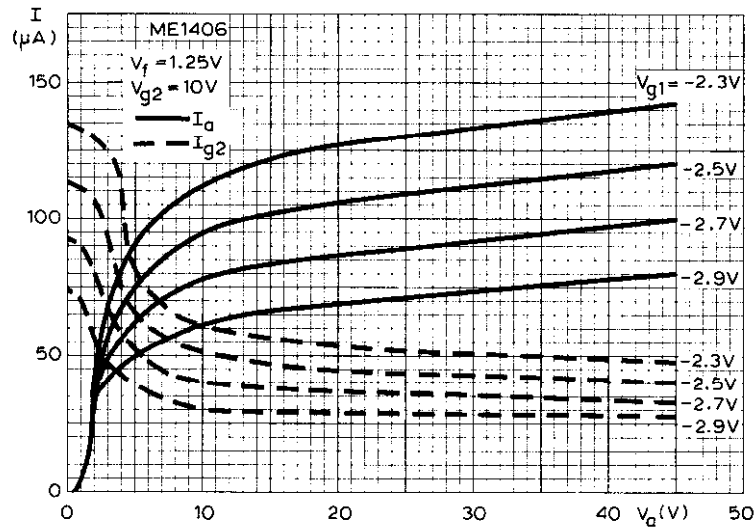

ANODE AND SCREEN-GRID CURRENTS PLOTTED AGAINST ANODE VOLTAGE WITH CONTROL-GRID VOLTAGE AS PARAMETER. $V_{g2} = 10V$.





VIBRATING CAPACITOR

XL7900

QUICK REFERENCE DATA

Vibrating membrane capacitor in an evacuated envelope for use as a d.c./a.c. converter, for example in dosimeters, pH meters and electrometer equipment, where a very high input resistance is of paramount importance. Equipment capable of measuring currents as low as 500 electrons per second ($8 \times 10^{-17}A$) has been constructed, using this device.

Contact potential	-50 to +50	mV
Short term drift of contact potential	100	μV
Minimum insulation resistance	10^{15}	Ω
Maximum overall length	64.7	mm
Maximum diameter	30.2	mm

PRINCIPLE OF OPERATION (D.C. measurement)

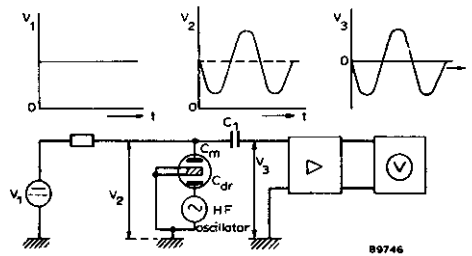

The direct voltage to be measured is connected to capacitor C_m (measuring capacitor). The earthed membrane vibrates at its own resonance frequency (about 6kHz), due to a high frequency electric field between the electrodes of capacitor C_{dr} (driving capacitor). Thus the direct voltage on C_m is modulated at the resonance frequency of the membrane. Capacitor C_1 blocks the direct voltage from the a.c. amplifier. The output alternating voltage is proportional to the input direct voltage.

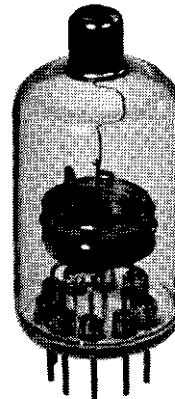

CHARACTERISTICS

Contact potential over measuring capacitor	-50 to +50	mV
Short term drift (within one day)	100	μ V
Long term drift (within one month)	1.0	mV
Temperature coefficient	20	μ V/degC

Conversion efficiency

At any given driving voltage the ratio $\frac{\text{R.M.S. output voltage}}{\text{D.C. input voltage}}$ will show a maximum spread of $\pm 60\%$.

Driving voltage

A value of high frequency driving voltage can always be found at which all capacitors have a conversion efficiency between 10 and 40% (see note 1).

Minimum insulation resistance between any two capacitor terminals (see note 2)	10^{15}	Ω
Resonance frequency of the membrane	5.3 to 6.3	kHz
Drift	1.5	%
Temperature coefficient	± 1.0	Hz/degC
Capacitances of measuring and driving capacitors	35	pF
Temperature drift	1.0	pF

RATINGS (ABSOLUTE MAXIMUM SYSTEM)

Maximum direct voltage on measuring capacitor	25	V
Maximum conversion efficiency	40	%

(Above 40% it is possible that the two capacitor plates will touch each other and will be damaged.)

SHOCK AND VIBRATION RESISTANCE

The following tests are applied to assess the mechanical quality of the tube. These conditions are not intended to be used as normal operating conditions.

Shock

The tube is subjected five times in each of four positions to an acceleration of 500g supplied by an NRL shock machine with the hammer lifted over an angle of 30° .

Vibration

The tube is subjected to a vibration of 15 to 1500Hz with an acceleration of 2.5g.

MOUNTING POSITION

Any

NOTES

- For instance, in apparatus constructed from the circuit shown in Fig. 2, it was found that all capacitors have a conversion efficiency between 10 and 40% with a voltage across L_1 of 1V r.m.s.



VIBRATING CAPACITOR

XL7900

NOTES (contd.)

2. Under standard atmospheric conditions as defined in I.E.C. publication 68-1, i.e. any combination of temperature, humidity and pressure within the following limits:

Temperature	+15 to +35	°C
Relative humidity	45 to 75	%
Pressure	860 to 1060	mbar

3. The capacitive drive opens the possibility to use as driving signal for the membrane a high frequency signal, amplitude modulated with the resonance frequency of the vibrating membrane.

Since in this case there is a great difference between the frequency of the driving signal and the modulation frequency of the voltage to be measured, the stray influences of the driving signal can easily be kept away from the measuring amplifier. In addition, a high frequency drive simplifies the design and construction of the driving oscillator.

OUTLINE DRAWING

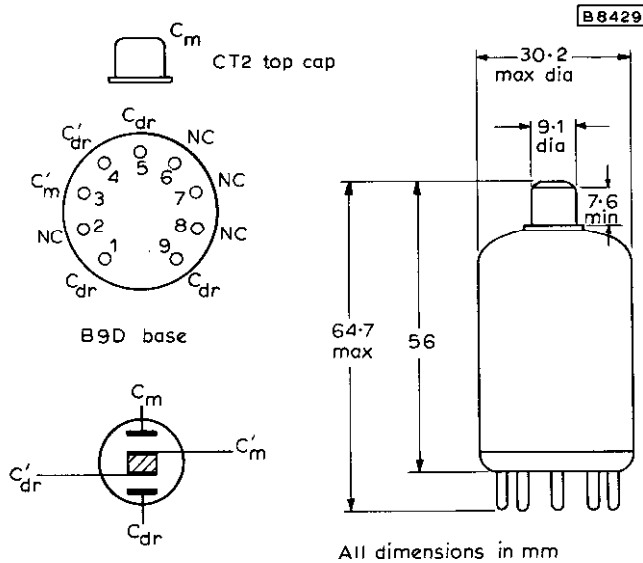

EXAMPLE OF A DRIVING OSCILLATOR

Operating principle

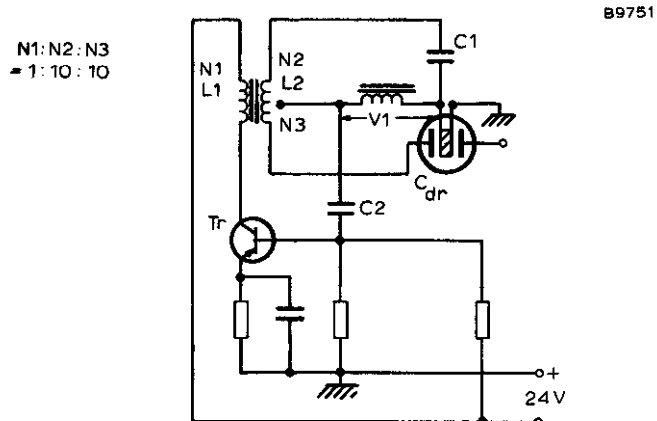

Fig. 1

The driving capacitor C_{dr} is incorporated in an impedance bridge that determines the feedback to the amplifier transistor. Capacitor C_1 has been given a slightly larger value than that of capacitor C_{dr} in its quiescent state. Due to this, the fed-back alternating voltage V_1 has the correct phase and amplitude to cause the circuit to oscillate at a frequency that is mainly determined by the network $L_2 C_1 C_{dr}$.

The electric attractive force between the capacitor plates of C_{dr} makes the membrane move towards the fixed plate of C_{dr} , as a result of which its capacitance increases, the transistor receives less feedback, and the oscillator voltage decreases.

The phases and amplitudes of the electrical and mechanical forces on the membrane, and of the feedback factor, are such that the membrane begins to vibrate at its resonance frequency and the h.f. voltage is amplitude modulated with this frequency.

Since it is very difficult to construct this circuit in such a way that stable operation is ensured, it is advisable to add components for automatic control of C_1 , as in the following circuit.

VIBRATING CAPACITOR

XL7900

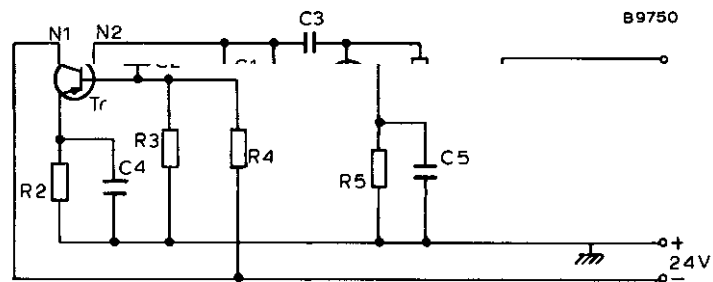

Fig. 2

$C_1 = 12\text{pF mica}$	$R_1 = 68\text{k}\Omega$	$L_2 = 1.3\text{mH}$
$C_2 = 1.5\text{nF}$	$R_2 = 3.3\text{k}\Omega$	$L_3 = 1.3\text{mH R.F. choke}$
$C_3 = 10\text{pF mica}$	$R_3 = 4.7\text{k}\Omega$	$N_2/N_1 = 20$
$C_4 = 2.2\text{nF}$	$R_4 = 1\text{k}\Omega$	$T_r = \text{BCY70}$
$C_5 = 0.1\mu\text{F}$	$R_5 = 1\text{M}\Omega$	$D = \text{BA102 (variable capacitance diode)}$
$C_t = 25\text{pF max.}$		

The issue of the information contained in this publication does not imply any authority or licence for the utilisation of any patented feature.

