

QUICK REFERENCE DATA

Disc seal triode, intended as a broadband low power amplifier or frequency multiplier.

f	4.0	Gc/s
P_{load}	1.8	W
$f_{max.}$	4.0	Gc/s
$V_a_{max.}$	300	V
$p_a_{max.}$	12.5	W

To be read in conjunction with

GENERAL OPERATIONAL RECOMMENDATIONS - TRANSMITTING VALVES

HEATER

$*V_h$	6.3	V
I_h	750	mA

*The absolute variation of heater voltage should be less than $\pm 2\%$.

MOUNTING POSITION

Any

CAPACITANCES (measured with $V_h = 6.3V$, $I_k = 0mA$)

C_{a-g}	1.4	pF
C_{a-k}	35	mpF
C_{g-k}	3.0	pF

CHARACTERISTICS

measured at $V_a = 180V$, $I_a = 60mA$

	Min.	Av.	Max.	
V_g	0	-1.25	-2.5	V
g_m	15	21	-	mA/V
μ	33	43	52	

measured at $V_a = 180V$, $I_a = 30mA$

	Av.	
V_g	-2.8	V
g_m	18	mA/V

COOLING

In order to keep within the seal temperatures, a low velocity air flow may be required.

Maximum temperatures

Anode seal	150	°C
Grid seal	75	°C
Cathode seal	75	°C

ABSOLUTE MAXIMUM RATINGS

$V_{a(b)}$ max.	500	V
V_a max.	300	V
p_a max.	12.5	W
$+V_g$ max.	0	V
$-V_g$ max.	50	V
I_g max.	10	mA
p_g max.	200	mW
I_k max.	70	mA
* $P_{load (driver)}$ max.	1.0	W
† R_{g-k} max. (fixed bias)	3.0	kΩ
V_{h-k} max.	50	V
R_{h-k} max.	20	kΩ

*Grounded grid connection ($f = 4.0\text{Gc/s}$).

†This value can be multiplied by the d.c. inverse feedback factor to a maximum of $25\text{k}\Omega$.

RECOMMENDED OPERATION

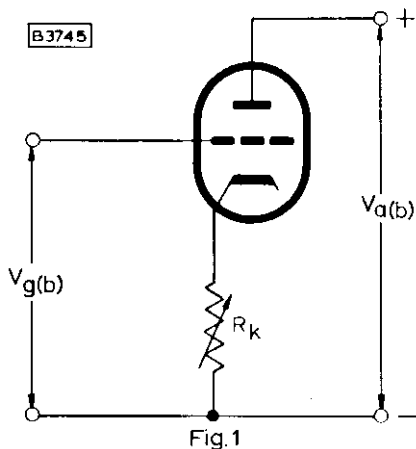

Fig.1

f	4.0	4.0	Gc/s
$V_{a(b)}$	200	200	V
$V_{g(b)}$	+20	+20	V
* R_k	1.0	0.5	k Ω
I_a	30	60	mA
Bandwidth (-0.1dB)	50	50	Mc/s
P_{load} (at $V_h = 6.3V$)			
Gain = 8dB	-	1.8	W
		(min. 1.5)	
Gain = 6dB	0.5	-	W
	(min. 0.35)		
Gain (P_{load} (driver) = 1mW)	13	13	dB
	(min. 10)	(min. 10)	

* R_k should consist of a variable resistor and be adjusted to give the required anode current (see Fig.1).

MOUNTING POSITION

In order to screw the valve into a cavity a key with a slip torque of 15kgcm max. is recommended. This should be a key with studs which fit into the notches in the tube base. It is inadvisable to use a device which utilises the pins of the valve base.

DIMENSIONS

	Inches	Millimetres	
A	0.831 ± 0.004	21.1 ± 0.1	
B	0.563 ± 0.001	14.3 ± 0.03	
C	0.250 ± 0.002	6.35 ± 0.05	
D	0.248 ± 0.001	6.3 ± 0.02	
E	0.039	1.0	max.
F	0.031 ± 0.004	0.8 ± 0.1	
G	0.187 ± 0.006	4.75 ± 0.15	
H	0.024 ± 0.004	0.6 ± 0.1	
J	0.878 ± 0.020	22.3 ± 0.5	
K	0.374 ± 0.006	9.5 ± 0.15	
L	0.138 ± 0.008	3.5 ± 0.2	
M	0.059	1.5	max.
N	0.098	2.5	max.
P	1.028 ± 0.008	26.1 ± 0.2	
Q	1.791	45.5	max.
R	2.362	60	max.
S	0.433 ± 0.020	11 ± 0.5	
T	0.339 ± 0.020	8.6 ± 0.5	
U	1.252 ± 0.008	31.8 ± 0.2	
W	0.472	12	max.
X	1.292	32.8	max.
Y	0.039	1.0	max.
Z	0.709 ± 0.008	18 ± 0.2	
AA	0.138	3.5	min.
BB	0.875	22.225	

Inch dimensions derived from original millimetre dimensions

03692

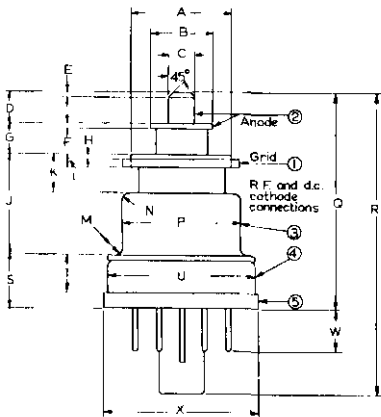

- ① The eccentricities are given with respect to the axis of the threaded hole shown in Fig.1, the grid disc of the tube being screwed firmly against the flange (with inner diameter of 18mm).
- ② Maximum eccentricity of the anode 0.15mm.
- ③ Maximum eccentricity of the cathode connection 0.20mm.
- ④ The tolerance of the eccentricity of the base is such that this base fits into a hole with a diameter of 32.5mm, providing this hole is correctly centred with respect to axis of the hole specified in Fig.1.
- ⑤ The tolerance of the eccentricity of the base flange is such that this base flange fits into a hole with a diameter of 33.5mm, providing this hole is correctly centred with respect to the axis of the hole specified in Fig.1.

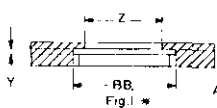

*Data of screw thread of grid disc and of recommended mount. 32 threads per inch, 60° thread angle;

	Minor diameter	Major diameter	Effective diameter
AA Grid	$21.22 - 0.15$	$22.2 - 0.15$	$21.68 - 0.09$
Fig.1	$21.51 - 0.15$	22.23 min.	$21.83 - 0.12$

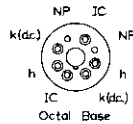
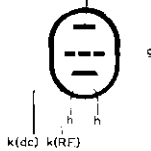

Plugs 3 and 8 are connected internally to the cathode disc terminal

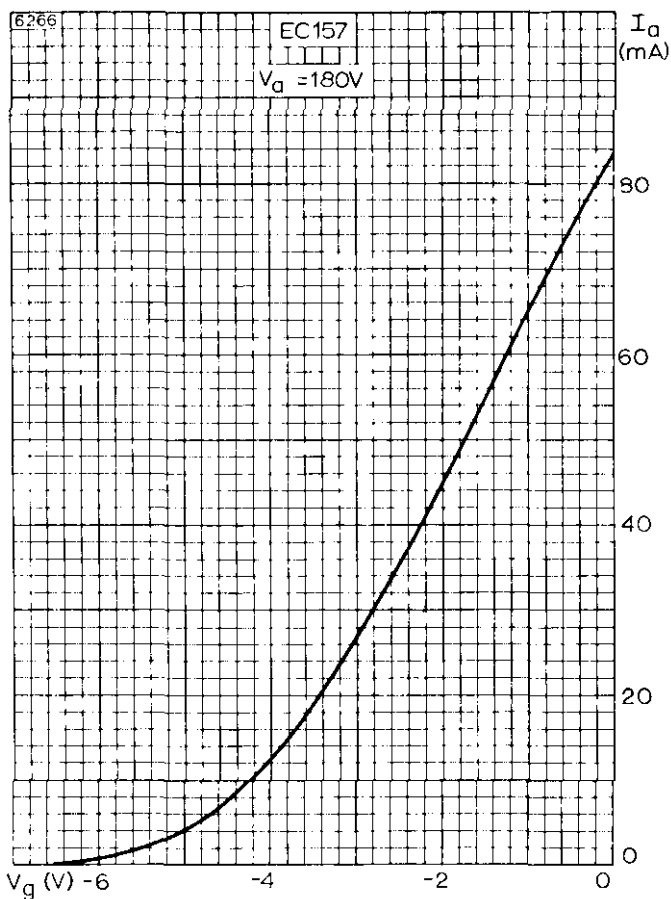

ANODE CURRENT PLOTTED AGAINST GRID VOLTAGE

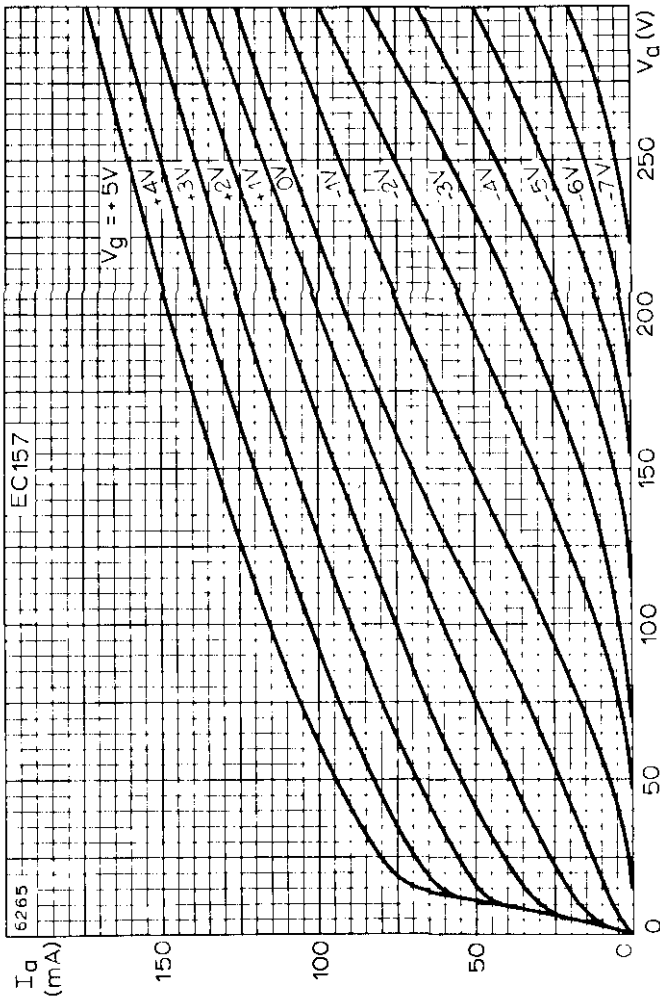

ANODE CURRENT PLOTTED AGAINST ANODE VOLTAGE WITH
GRID VOLTAGE AS PARAMETER

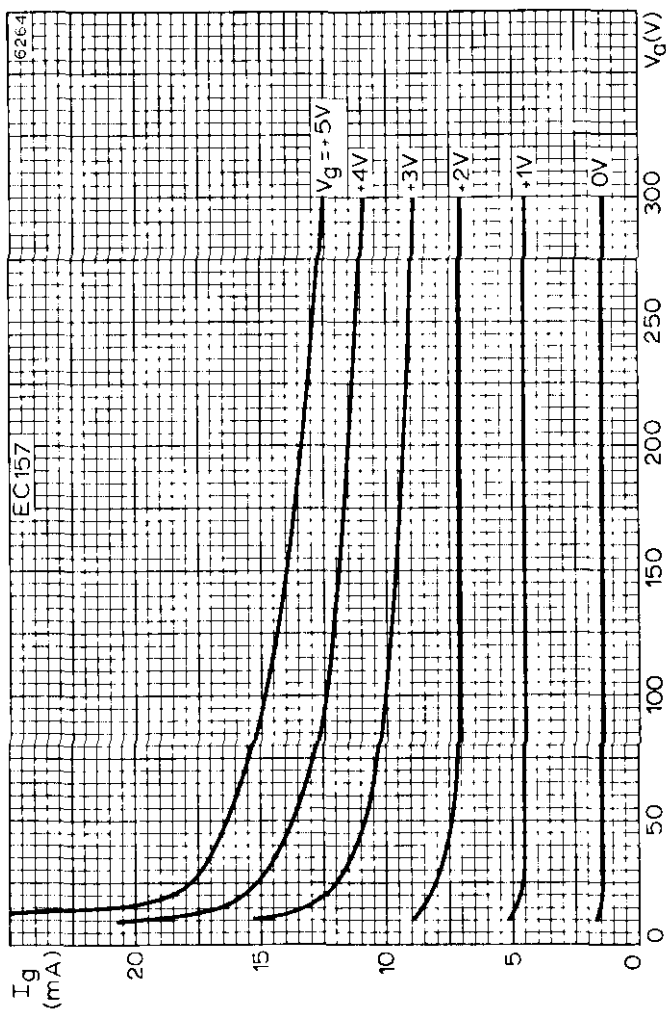

GRID CURRENT PLOTTED AGAINST ANODE VOLTAGE
WITH GRID VOLTAGE AS PARAMETER

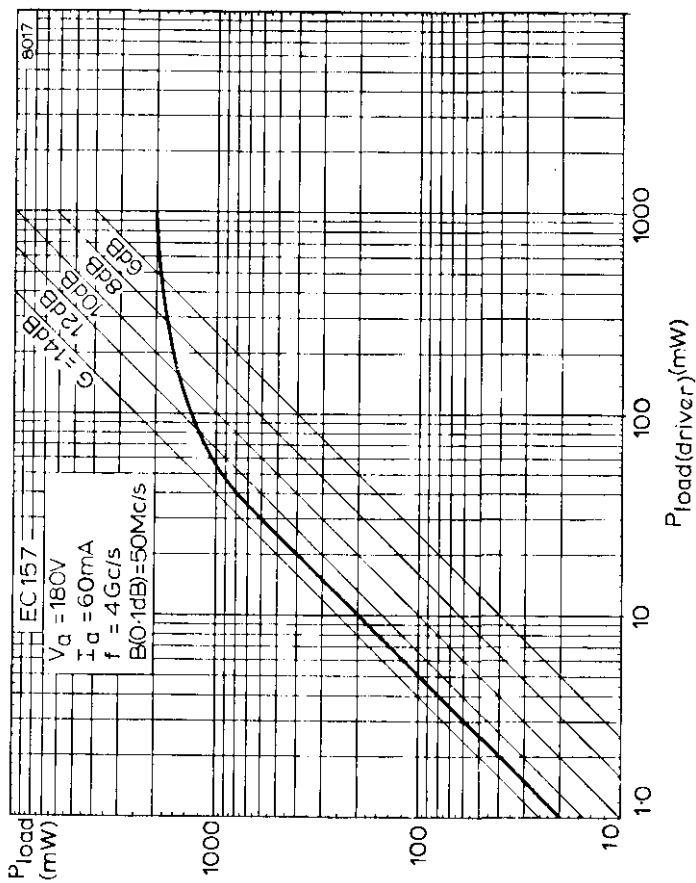

POWER GAIN AT 4.0Gc/s

QUICK REFERENCE DATA

Disc seal triode, intended as broadband low power amplifier or frequency multiplier.

f	4.2	Gc/s
P_{load}	5.3	W
$f_{max.}$	4.2	Gc/s
$V_a_{max.}$	300	V
$p_a_{max.}$	30	W

To be read in conjunction with

GENERAL OPERATIONAL RECOMMENDATIONS - TRANSMITTING VALVES

HEATER

$*V_h$	6.3	V
I_h	900	mA

*The absolute variation of heater voltage should be less than $\pm 2\%$.

MOUNTING POSITION

Any

CAPACITANCES (measured at $V_h = 6.3V$, $I_k = 0mA$)

c_{a-g}	1.7	pF
c_{a-k}	36	mpF
c_{g-k}	3.5	pF

CHARACTERISTICS

measured at $V_a = 180V$, $I_a = 60mA$

	Min.	Av.	Max.	
V_g	-5.5	-3.5	-1.5	V
g_m	17	22	27	mA/V
μ	20	30	40	

COOLING

In order to keep within the seal temperatures, a low velocity air flow may be required.

Maximum temperatures

Anode seal	150	°C
Grid seal	75	°C
Cathode seal	75	°C

ABSOLUTE MAXIMUM RATINGS

$V_{a(b)}$ max.	500	V
V_a max.	300	V
p_a max.	30	W
$+V_g$ max.	10	V
$+v_{g(pk)}$ max.	30	V
$-V_g$ max.	50	V
$-v_{g(pk)}$ max.	100	V
I_g max.	25	mA
p_g max.	350	mW
I_k max.	170	mA
$*P_{load (driver)}$ max.	2.0	W
$\dagger R_{g-k}$ max. (fixed bias)	3.0	k Ω
V_{h-k} max.	50	V
R_{h-k} max.	20	k Ω

*Grounded grid connection ($f = 4.2\text{Gc/s}$)

†This value can be multiplied by the d.c. inverse feedback factor to a maximum of 25k Ω .

RECOMMENDED OPERATION.

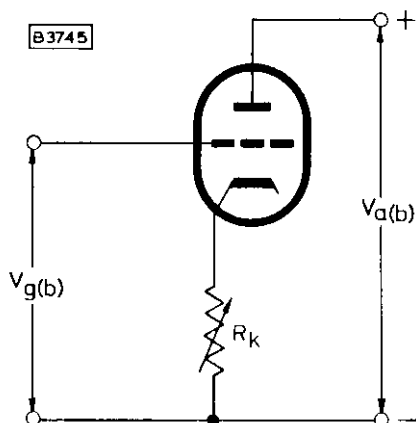

Fig.1

f	4.2	Gc/s
$V_{a(b)}$	200	V
$V_{g(b)}$	+20	V
$*R_k$	200	Ω
J_a	140	mA
Bandwidth (-0.1dB)	50	Mc/s
P_{load} Gain = 6dB	5.3	W
Gain (P_{load} (driver) = 10mW)	11.5	dB

* R_k should consist of a variable resistor and be adjusted to give the required anode current (see Fig.1).

MOUNTING NOTE

In order to screw the valve into a cavity a key with a slip torque of 15kgcm max. is recommended. This should be a key with studs which fit into the notches in the tube base. It is inadvisable to use a device which utilises the pins of the valve base.

DIMENSIONS

	Inches	Millimetres	
A	0.831 ± 0.004	21.1 ± 0.1	
B	0.563 ± 0.001	14.3 ± 0.03	
C	0.250 ± 0.002	6.35 ± 0.05	
D	0.248 ± 0.001	6.3 ± 0.02	
E	0.039	1.0	max.
F	0.031 ± 0.004	0.8 ± 0.1	
G	0.187 ± 0.006	4.75 ± 0.15	
H	0.024 ± 0.004	0.6 ± 0.1	
J	0.878 ± 0.020	22.3 ± 0.5	
K	0.374 ± 0.006	9.5 ± 0.15	
L	0.138 ± 0.008	3.5 ± 0.2	
M	0.059	1.5	max.
N	0.098	2.5	max.
P	1.028 ± 0.008	26.1 ± 0.2	
Q	1.791	45.5	max.
R	2.362	60	
S	0.433 ± 0.020	11 ± 0.5	
T	0.339 ± 0.020	8.6 ± 0.5	
U	1.252 ± 0.008	31.8 ± 0.2	
W	0.472	12	max.
X	1.291	32.8	max.
Y	0.039	1.0	max.
Z	0.709 ± 0.008	18 ± 0.2	
AA	0.138	3.5	min.
BB	0.875	22.225	

Inch dimensions derived from original millimetre dimensions

B3692

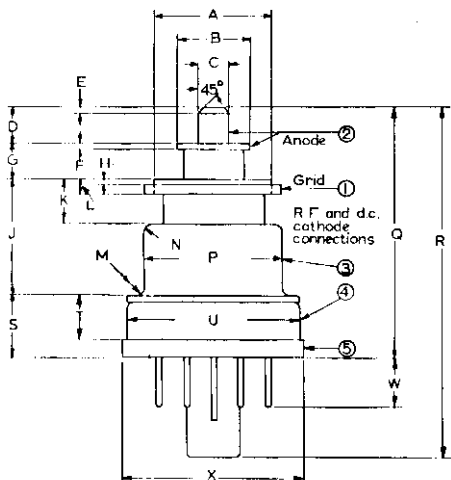

- ① The eccentricities are given with respect to the axis of the threaded hole shown in Fig.1, the grid disc of the tube being screwed firmly against the flange (with inner diameter of 18mm.)
- ② Maximum eccentricity of the anode 0.15mm.
- ③ Maximum eccentricity of the cathode connection 0.20mm.
- ④ The tolerance of the eccentricity of the base is such that this base fits into a hole with a diameter of 32.5mm, providing this hole is correctly centred with respect to axis of the hole specified in Fig.1.
- ⑤ The tolerance of the eccentricity of the base flange is such that this base flange fits into a hole with a diameter of 33.5mm, providing this hole is correctly centred with respect to the axis of the hole specified in Fig.1.

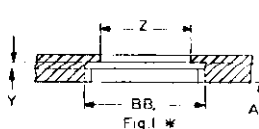

*Data of screw thread of grid disc and of recommended mount. 32 threads per inch, 60° thread angle;

	Minor diameter	Major diameter	Effective diameter
Grid	21.22 ⁺⁰ -0.15	22.2-0.15	21.68 ⁺⁰ -0.09
Fig.1	21.51 ⁺⁰ -0.15	22.23 min.	21.83 ⁺⁰ -0.12

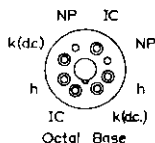
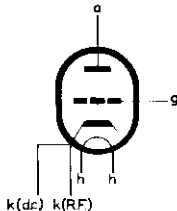

Pins 3 and 8 are connected internally to the cathode disc terminal

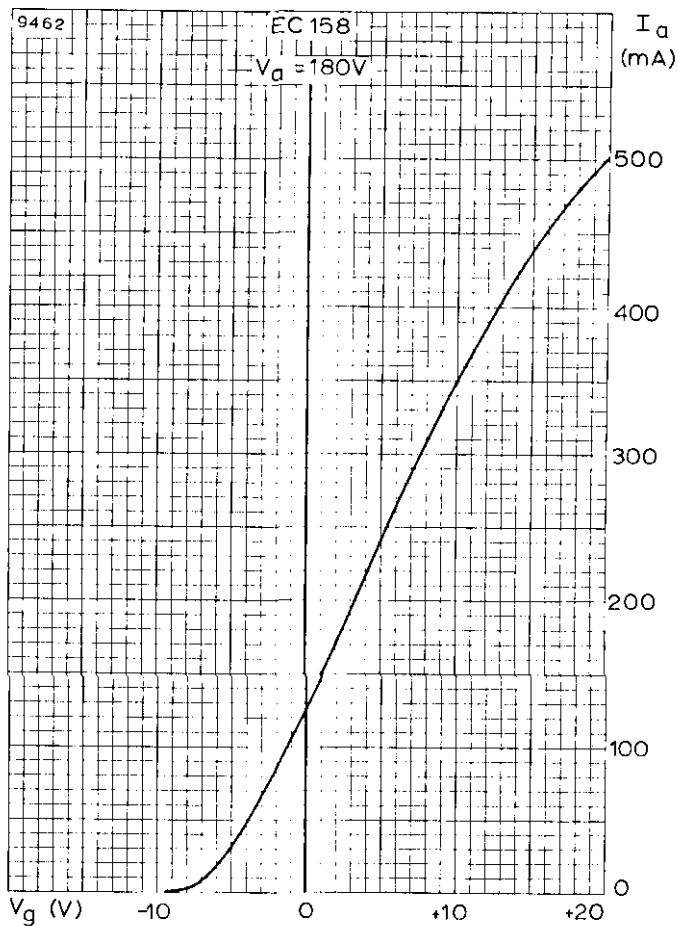

ANODE CURRENT PLOTTED AGAINST GRID VOLTAGE

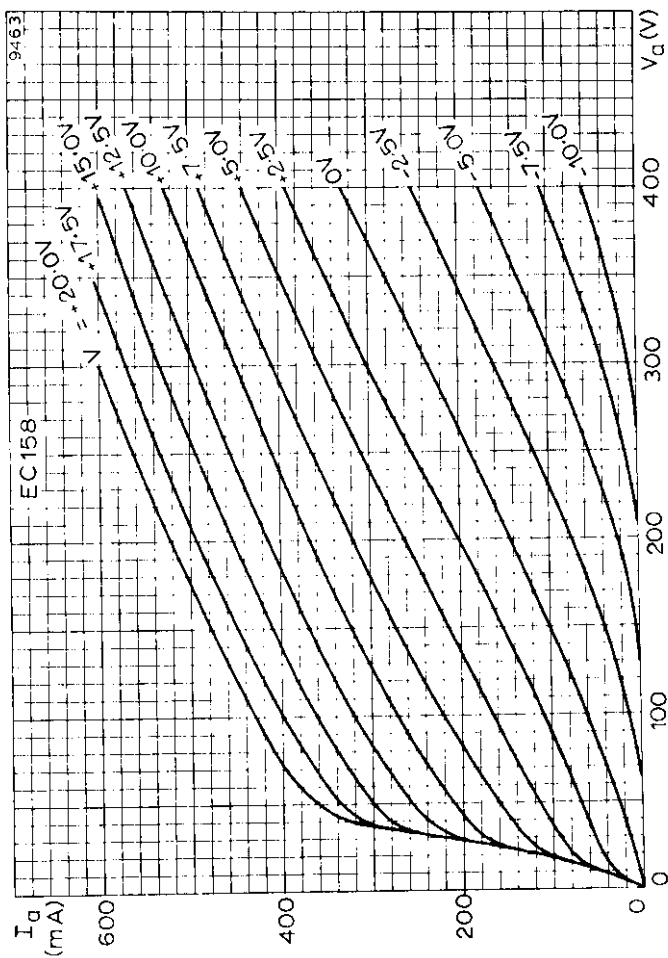

ANODE CURRENT PLOTTED AGAINST ANODE VOLTAGE, WITH GRID VOLTAGE AS PARAMETER

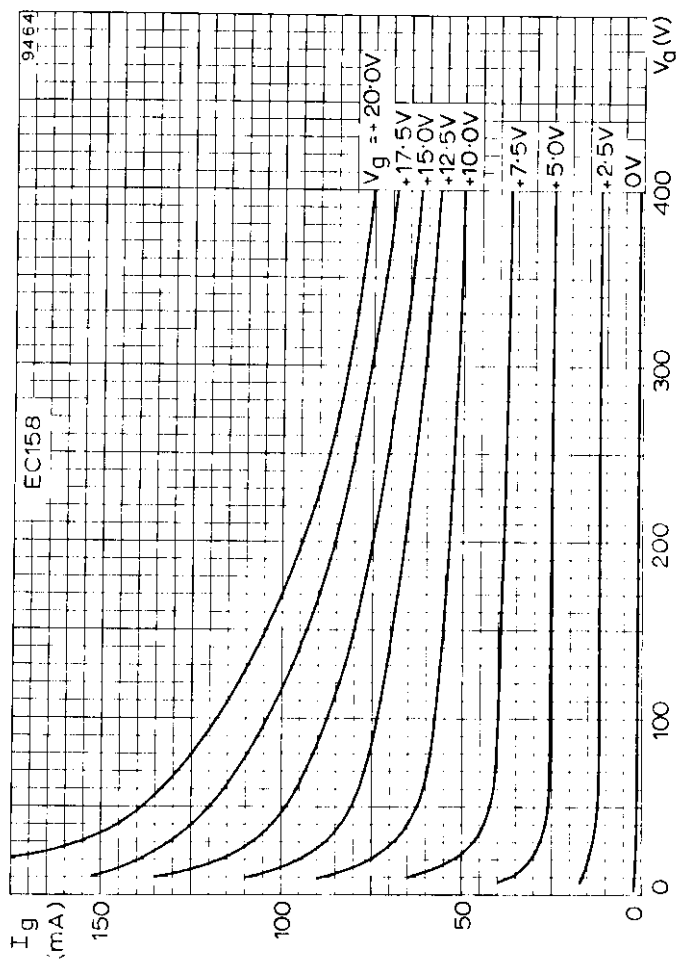

GRID CURRENT PLOTTED AGAINST ANODE VOLTAGE, WITH GRID VOLTAGE AS PARAMETER

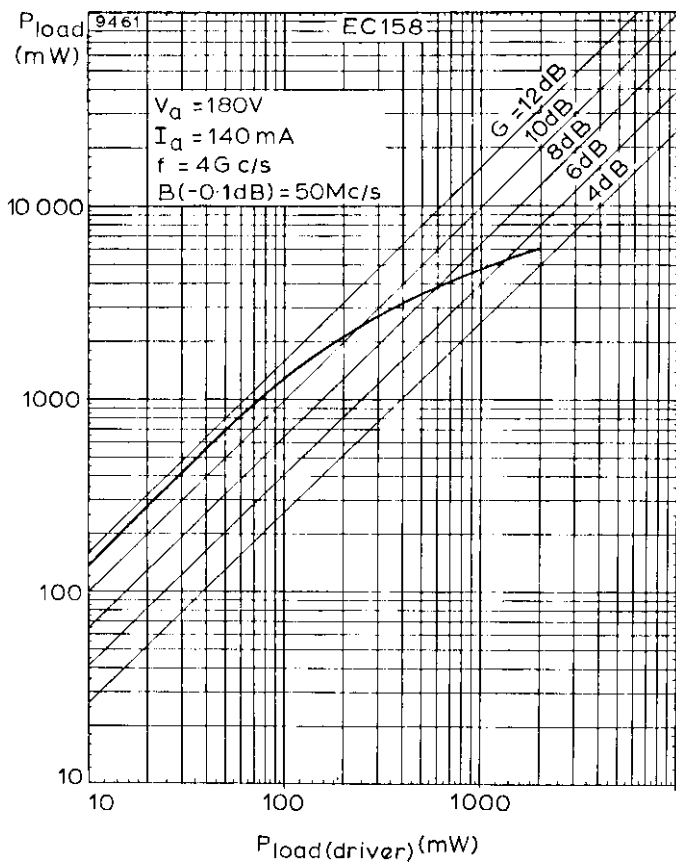

POWER GAIN AT 4.0Gc/s

QUICK REFERENCE DATA

Triode, ceramic construction, for use as an amplifier and frequency multiplier up to 3.5GHz.

	Telegraphy or F.M. Telephony Class 'C'	Frequency Doubler	
f	2.5	1.0 to 2.0	GHz
P _{out}	24	5.2	W
f max.	3.0	3.5	GHz
V _a max.	1.0	1.0	kV
p _a max.	100	100	W

To be read in conjunction with
GENERAL OPERATIONAL RECOMMENDATIONS - TRANSMITTING VALVES

TELEGRAPHY OR F.M. TELEPHONY, CLASS 'C'

OPERATING CONDITIONS (Oscillator)

f	2.5	2.5	GHz
P _{out}	16	24	W
P _{load}	10	16	W
V _a	600	800	V
I _a	100	100	mA
-V _g	18	20	V
I _g	22	20	mA
R _{g-h}	0.820	1.0	kΩ
P _a	44	56	W
η _a	27	30	%

FREQUENCY DOUBLER

OPERATING CONDITIONS

f	1.0 to 2.0	GHz
P_{out}	5.2	W
P_{load}	4.0	W
V_a	400	V
I_a	55	mA
$-V_g$	15	V
I_g	18	mA
P_{load} (driver)	1.5	W
p_a	17	W
η_a	24	%

RATINGS (ABSOLUTE MAXIMUM SYSTEM)

f max.	3.5	GHz
V_a max.	1.0	kV
$-V_g$ max.	150	V
I_k max.	125	mA
p_a max.	100	W
p_g max.	2.0	W
I_g max.	50	mA
R_{g-h} max.	10	k Ω

CATHODE

Indirectly heated

V_h	*6.0	V
I_h	0.9 to 1.05	A
t_{h-k} min.	60	s

*The heater voltage must be adjusted to compensate for back heating of the cathode, which occurs at higher frequencies. Reduction values of heater voltage should be taken from the curves on page C5.

Maximum heater voltage fluctuation should not exceed $\pm 5\%$.

CAPACITANCES

c_{a-g}	2.05	pF
c_{a-k}	<0.035	pF
c_{g-k}	6.3	pF
c_{a-k} ($V_h = 6.0V, I_k = 0$)	<0.045	pF
c_{g-k} ($V_h = 6.0V, I_k = 0$)	7.5	pF

CHARACTERISTICS (measured at $V_a = 600V, I_a = 75mA$)

g_m	25	mA/V
μ	100	

MOUNTING POSITION

Any

COOLING

Anode - forced-air cooled. See page C5.

Ceramic to metal seals - low velocity air flow

Temperatures

Anode max.	250	$^{\circ}C$
Seals max.	250	$^{\circ}C$

ACCESSORIES

The construction and design of a suitable cowling depends upon the type of equipment in use. The dimensions of a suitable design are given on page D4.

When mounting in co-axial resonators use of resilient spring contacts is recommended.

PHYSICAL DATA

Weight of valve	70	g
	2.5	oz

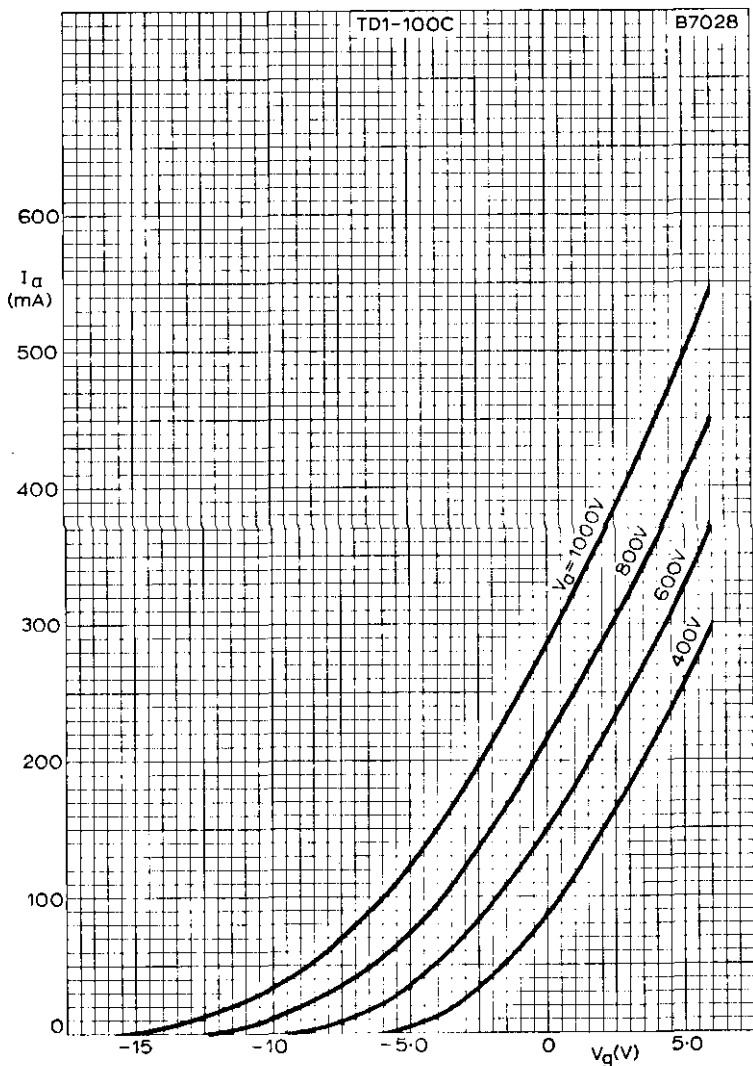

ANODE CURRENT PLOTTED AGAINST GRID VOLTAGE WITH ANODE VOLTAGE AS PARAMETER

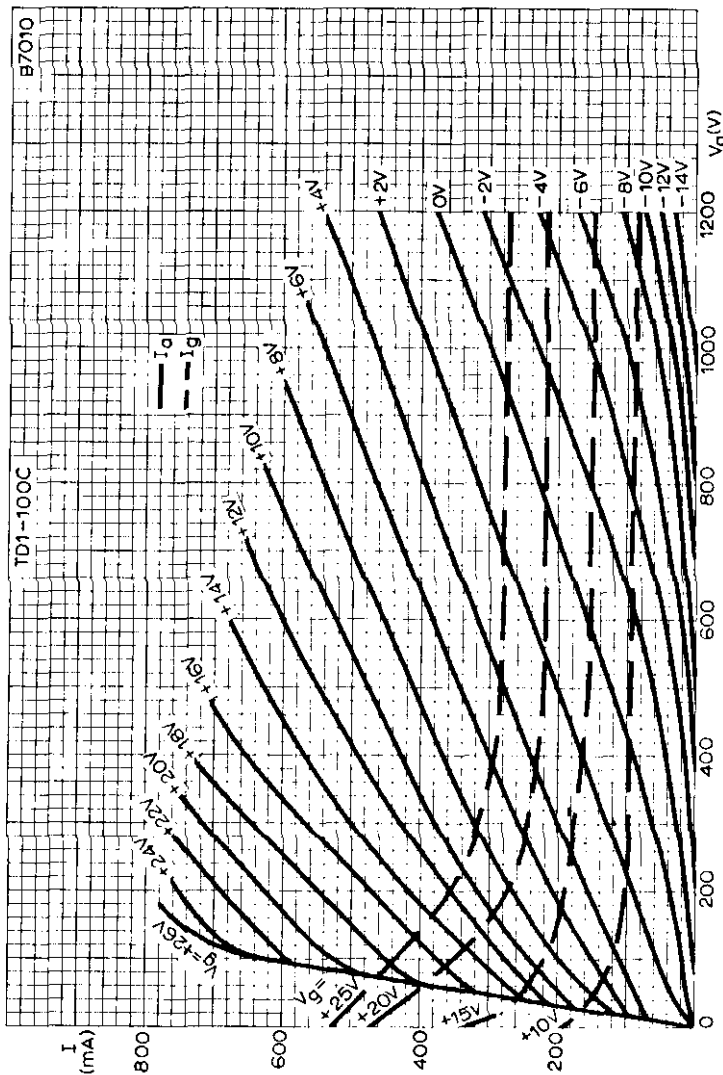

CONSTANT VOLTAGE CHARACTERISTICS



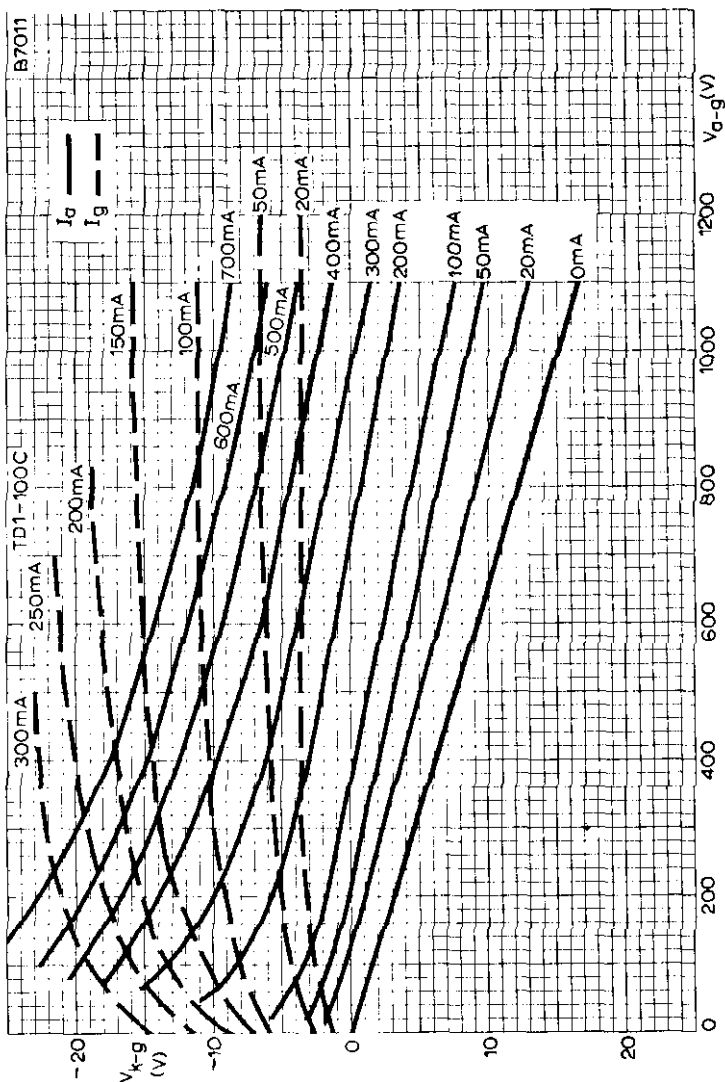

CONSTANT CURRENT CHARACTERISTICS

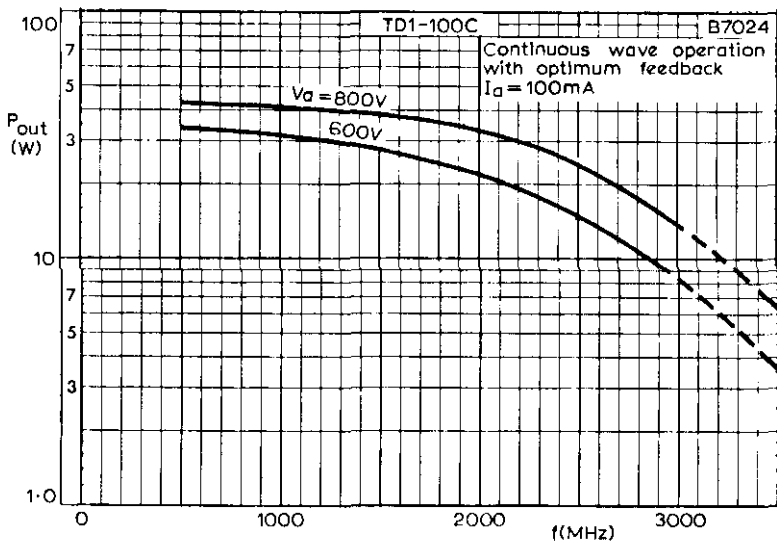

OUTPUT POWER PLOTTED AGAINST FREQUENCY FOR SELECTED ANODE VOLTAGES. CONTINUOUS WAVE OPERATION

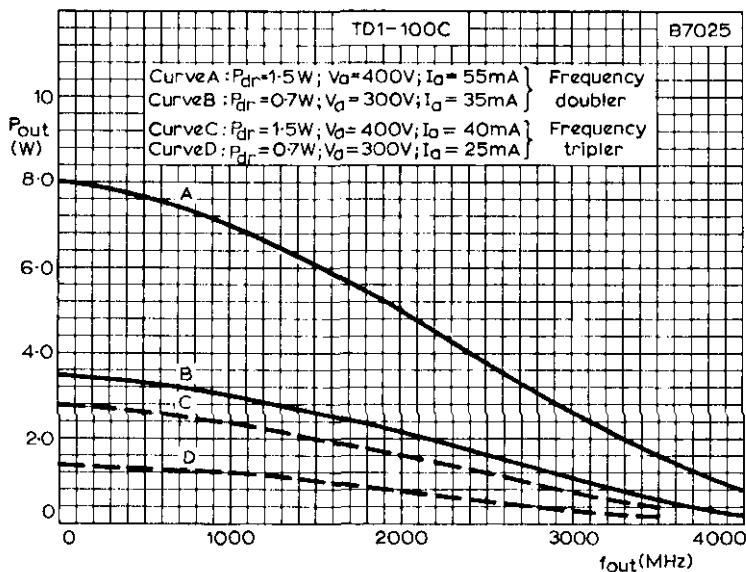

OUTPUT POWER PLOTTED AGAINST FREQUENCY FOR SELECTED DRIVE POWERS

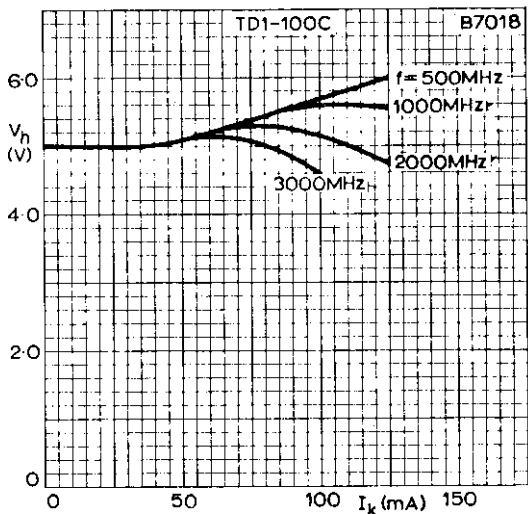

HEATER DERATING CHARACTERISTICS

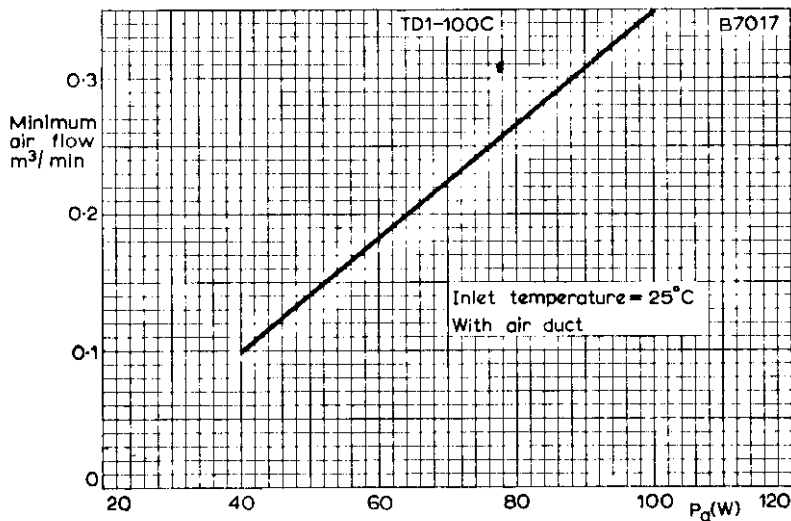

MINIMUM AIR FLOW PLOTTED AGAINST ANODE DISSIPATION

Application: R.F. amplifier
 Frequency: 2.0Gc/s
 Construction: Disc seal, natural cooling

This data should be read in conjunction with GENERAL OPERATIONAL RECOMMENDATIONS—TRANSMITTING VALVES included in this section of the handbook.

HEATER

V_{H_1}	6.3	V
I_{H_1}	400	mA

MOUNTING POSITION

Any

CAPACITANCES

$C_{01} \mu$	1.0	pF
$C_{01} k$	10	mpF
$C_{02} k$	2.0	pF

CHARACTERISTICS

V_a	250	V
I_a	10	mA
μ	70	
g_m	6.5	mA/V

OPERATING CONDITIONS

V_a	250	V
V_k	-2.0	V
I_a	10	mA
Noise factor		
at 1.0Gc/s with 15dB power gain	9.5	dB
at 1.5Gc/s with 13.5dB power gain	12	dB
at 2.0Gc/s with 11.5dB power gain	14.5	dB

LIMITING VALUES

V_{ik} max.	350	V
I_{ik} max.	25	mA
p_a max.	5.0	W
$T_{\text{anode seal}}$ max.	140	°C

In order to limit the anode seal temperature and also to limit the rate of change of temperature it is necessary that the mass of metal in close thermal contact with the anode disc shall not be less than 45g ($1\frac{1}{2}$ oz) of brass or its thermal equivalent.

DIMENSIONS

	<i>Inches</i>	<i>Millimetres</i>	
A	0.876	22.25	max.
B	1.053	26.75	max.
C	0.621 : 0.039	15.75 : 1.00	
D	0.165 : 0.004	4.2 : 0.1	
E	0.012	0.3	
F	*	*	
G	0.876 : 0.004	22.25 : 0.10	
H	0.748 : 0.006	19.00 : 0.15	
J	0.484	12.3	max.
K	0.539	13.7	min.
L	0.748 +0.000 -0.010	19.00 +0.00 -0.25	
M	1.366 : 0.039	34.7 : 1.0	
N	1.575 : 0.020	40.0 : 0.5	
P	†	†	
Q	0.187 : 0.004	4.75 : 0.10	
R	0.044 : 0.001	1.120 : 0.025	
S	1.073 : 0.010	27.25 : 0.25	
T	0.709	18	min.
U	0.512	13	
V	0.433 : 0.010	11.00 : 0.25	
W	0.898 : 0.005	22.80 : 0.12	
X	0.776 : 0.005	19.70 : 0.12	
Y	0.748	19	
Z	0.039 +0.000 -0.006	1.00 +0.00 -0.15	
AA	0.248	6.3	
BB	0.187	4.76	
CC	0.364 : 0.010	9.25 : 0.25	
DD	0.315	8.0	min.
EE	0.020 +0.000 -0.003	0.500 +0.000 -0.075	
FF	0.677	17.2	max.
GG	0.125	3.17	
HH	0.094	2.38	
JJ	0.046	1.18 (No. 56 drill)	

*To fit inside a cylinder of 17.5mm (0.689in) diameter co-axial with the anode disc. This diameter may be continued to maximum length.

†Grid disc to fit co-axially inside a cylinder of 17.2mm (0.677in) diameter.

Note—The eccentricity of the grid, cathode and heater contacts shall not exceed 0.375mm (0.015in).

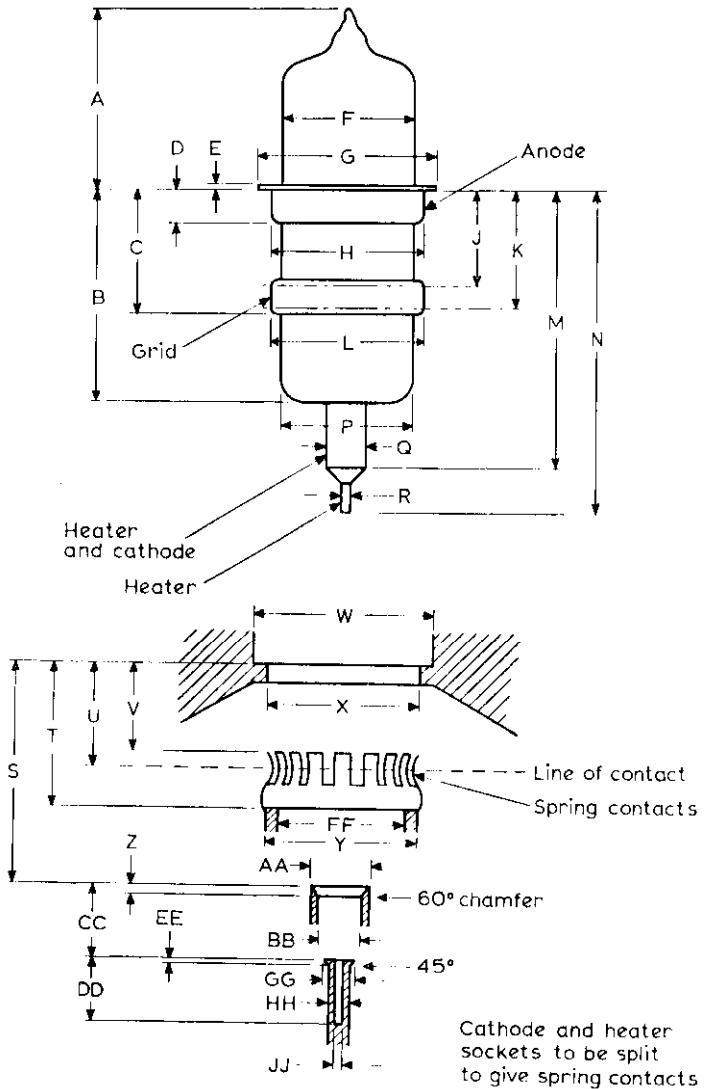

8128

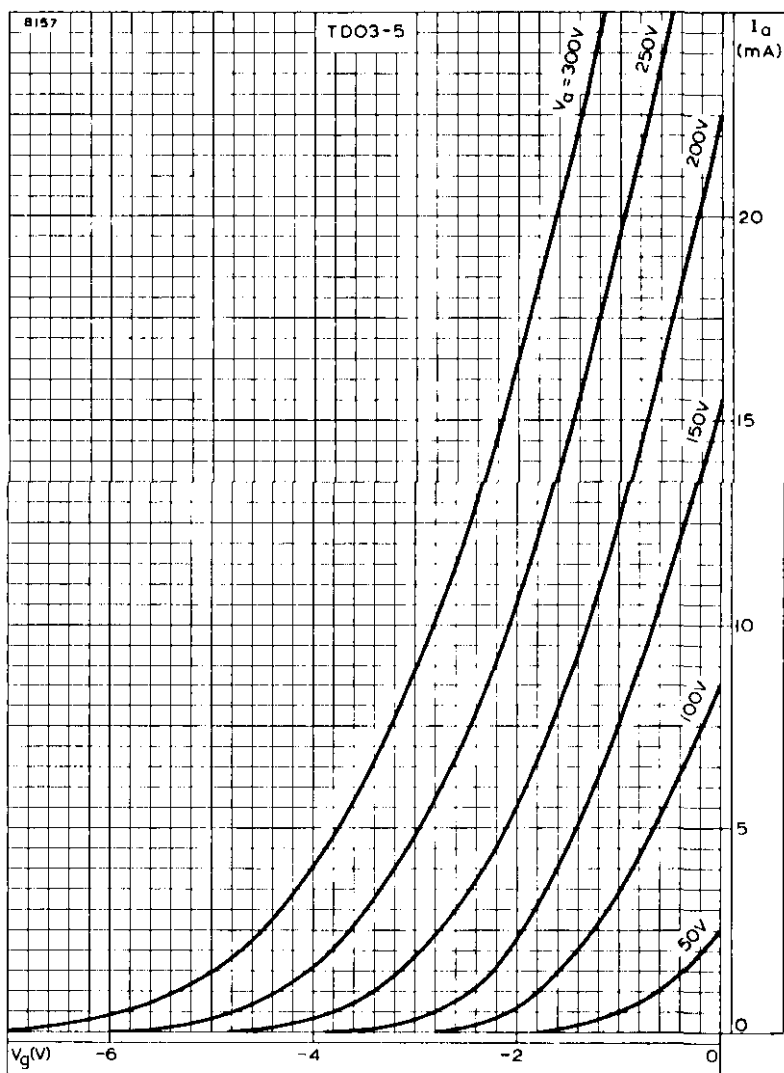

ANODE CURRENT PLOTTED AGAINST GRID VOLTAGE WITH ANODE VOLTAGE AS PARAMETER

QUICK REFERENCE DATA

Disc seal triode, intended for use in a common grid, earthed anode, concentric line oscillator or power amplifier.

f	1.0	Mc/s
Pout	2.8	W
f max.	3.75	Mc/s
Va max.	350	V
pa max.	10	W

To be read in conjunction with GENERAL OPERATIONAL RECOMMENDATIONS - TRANSMITTING VALVES.

HEATER

Indirectly heated

Vh	6.3	V
Ih (approx.)	0.4	A

CAPACITIES

ca-g	1.1	pF
ca-k	20	mpF
cg-k	2.2	pF

CHARACTERISTICS

Measured at Va = 250V, Vg = -3.5V, Ia = 20mA

gm	6.0	mA/V
μ	30	

LIMITING VALUES

Va max.	350	V
pa max.	10	W
Ia max.	50	mA
ia(pk) max.	150	mA
pg max.	0.5	W
Tanode-seal max.	140	$^{\circ}$ C
Tgrid-seal max.	140	$^{\circ}$ C

In order to limit the rate of change of anode seal temperature, it is necessary that the mass of metal in close thermal contact with the anode disc shall not be less than 2oz (60g) of brass or its thermal equivalent.

OPERATING NOTES

A typical circuit arrangement is shown where the anode-to-grid and grid-to-cathode circuits are both coaxial lines, the grid line being common to both circuits.

Tuning is effected in both circuits by means of movable bridges which should ideally be a quarter of a wavelength in length to ensure that the actual contact occurs at a current node. Over the wavelength range 10 to 60cm a good compromise is obtained with a bridge of 2.5cm in length.

It is essential that perfect contact is maintained between the lines and the bridges.

The heater-to-cathode circuit may be tuned by means of a capacity bridge. For the longer wavelengths tuning is not essential but must be employed for wavelengths around 10cm. A bridge positioned 7.2cm from the valve end of the cathode line will give satisfactory operation over the range 8 to 12cm.

Feedback is obtained by means of an adjustable capacitive probe (6BA threaded rod) which makes contact with the anode line and passes through a 1/4-in hole in the grid line. For wavelengths longer than 30cm it is advisable to terminate the probe by a small circular disc. Below 30cm this is unnecessary, and at approximately 10cm the increased capacitance prohibits its use.

It is impossible to use a single probe position over each oscillator range and three positions A, B and C are given below for a typical circuit together with the range of wavelengths covered.

Probe position	Distance from anode plane (mm)	Range of λ with anode line $3/4 \lambda$ mode (cm)	Min. λ with anode line on $1/4 \lambda$ mode (cm)
A	28.5	9 to 14	24
B	43.5	11 to 19	29
C	58.5	12 to 24	35

Indirectly-heated disc seal triode, without internal feedback, primarily intended for use as a common grid, earthed anode, concentric line oscillator. It may also be used as a power amplifier.

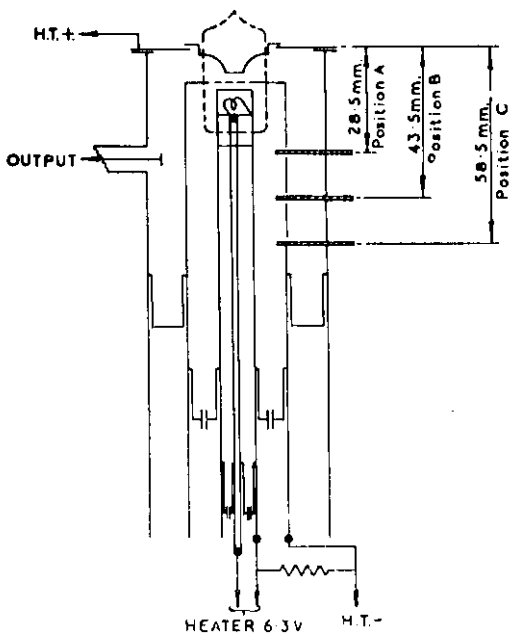
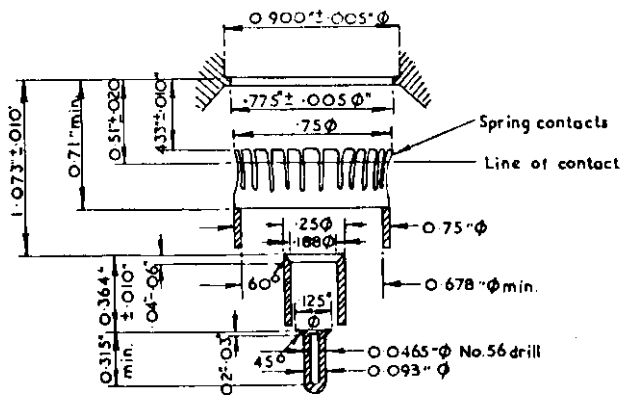

TYPICAL CIRCUIT ARRANGEMENT FOR OSCILLATOR

TD03-10

DISC SEAL TRIODE

Indirectly-heated disc seal triode, without internal feedback, primarily intended for use as a common grid, earthed anode, concentric line oscillator. It may also be used as a power amplifier.

In order that bias may be used, a capacitor is incorporated in the grid-cathode bridge. The optimum value of bias varies with frequency and the following table gives the approximate values of cathode resistor for various wavelengths.

Operating Wavelength (cm)	Cathode Bias Resistor (Ω)
30	300 to 350
15	100
12	0

Zero bias at a wavelength of 30 cm may cause a reduction in efficiency of 50%.

The output may be coupled into a 75Ω line by means of a capacitive probe and this can be adjusted for optimum coupling by sliding the probe along the line, or by varying the depth of penetration towards the grid line.

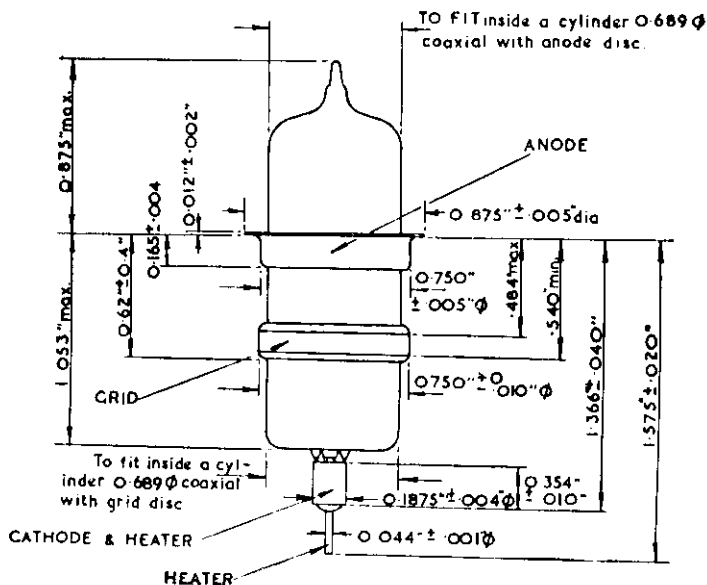

DISC SEAL TRIODE

TD03-10

Indirectly-heated disc seal triode, without internal feedback, primarily intended for use as a common grid, earthed anode, concentric line oscillator. It may also be used as a power amplifier.

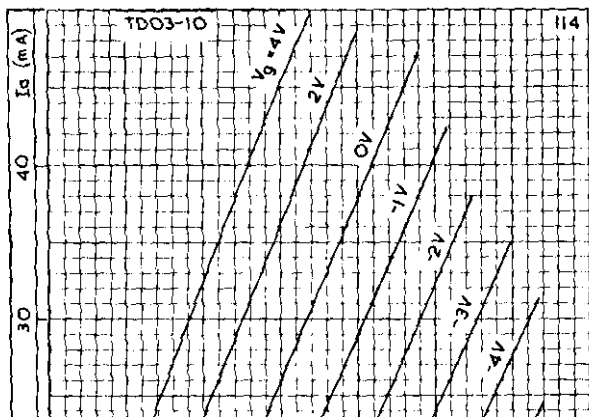

WITH GRID VOLTAGE AS PARAMETER

TD03-10

DISC SEAL TRIODE

Indirectly-heated disc seal triode, without internal feedback, primarily intended for use as a common grid, earthed anode, concentric line oscillator. It may also be used as a power amplifier.

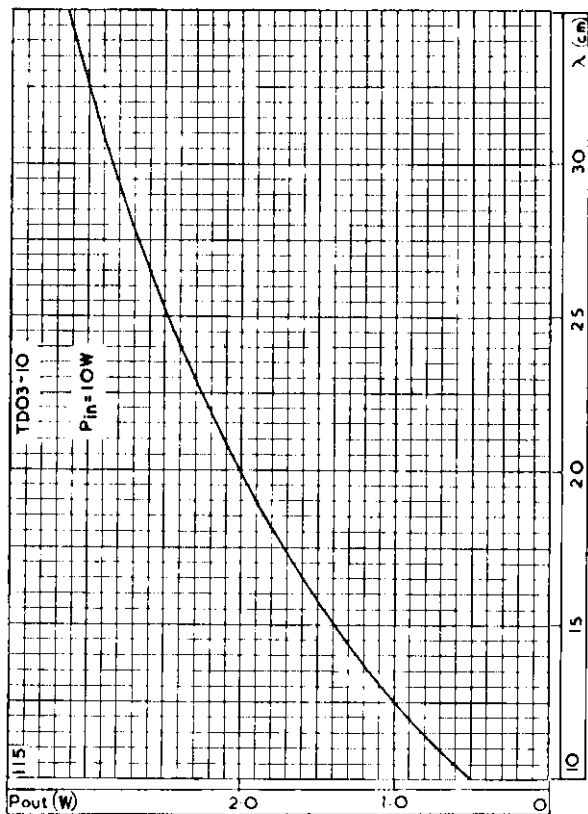

OUTPUT POWER PLOTTED AGAINST WAVELENGTH



Indirectly heated disc seal triode, with internal feedback, primarily intended for use as a common grid earthed, anode, concentric line oscillator.

This data should be read in conjunction with GENERAL OPERATIONAL RECOMMENDATIONS — TRANSMITTING VALVES included in this volume of the handbook.

HEATER

V_h	6.3	V
I_h (approx.)	400	mA

MOUNTING POSITION

Any

CAPACITANCES

C_{n-k}	1.4	pF
C_a-k	0.045	pF
C_g-k	1.7	pF

CHARACTERISTICS (measured at $V_h = 250V$, $I_h = 20mA$, $V_g = -3.5V$)

g_m	6.0	mA/V
μ	30	

COOLING

$T_{\text{anode seal max.}}$	140	°C
------------------------------	-----	----

In order to limit the anode seal temperature and also to limit the rate of change of anode seal temperature, it is necessary that the mass of metal in close thermal contact with the anode disc shall not be less than 60g (2oz) of brass or its thermal equivalent.

LIMITING VALUES

V_h max.	350	V
p_a max.	10	W
i_a max.	50	mA
$i_{a(pk)}$ max.	150	mA
p_g max.	500	mW

TD03-10F

DISC SEAL TRIODE

Indirectly heated disc seal triode, with internal feedback, primarily intended for use as a common grid, earthed anode, concentric line oscillator.

Fig. 4

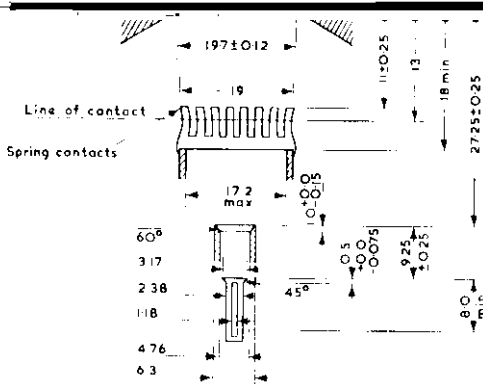
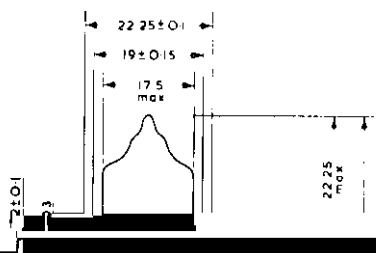

Note

Eccentricity of grid, cathode and heater contacts shall not exceed 0.375

All dimensions in mm

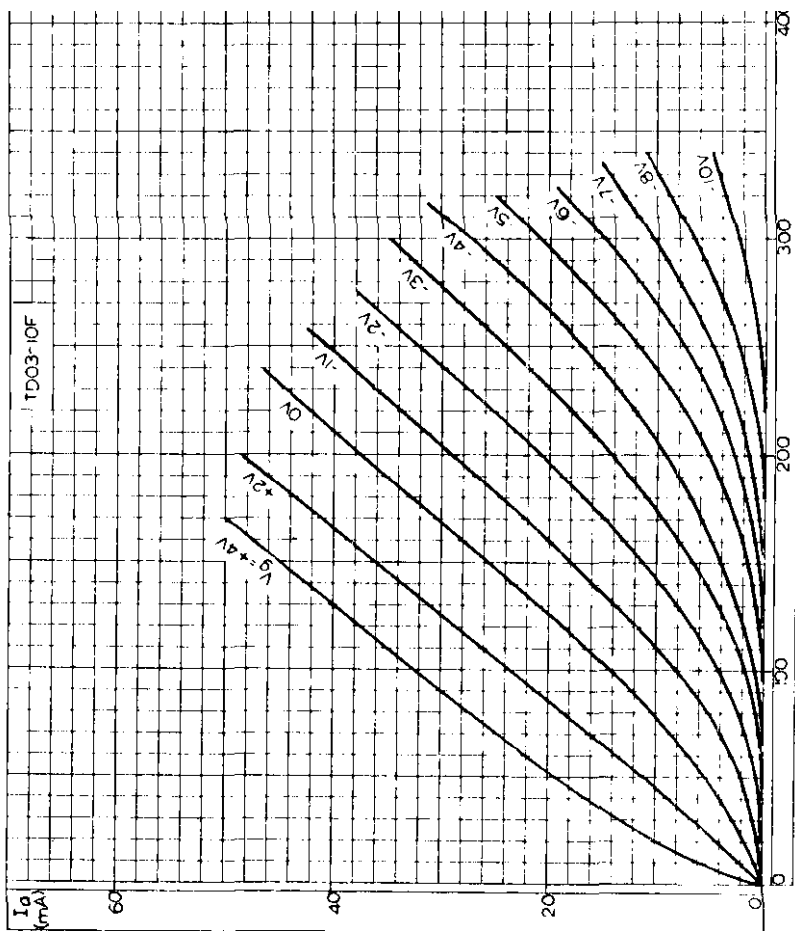

ANODE CURRENT PLOTTED AGAINST ANODE VOLTAGE

TD03-10F

DISC SEAL TRIODE

Indirectly heated disc seal triode, with internal feedback, primarily intended for use as a common grid, earthed anode concentric line oscillator.

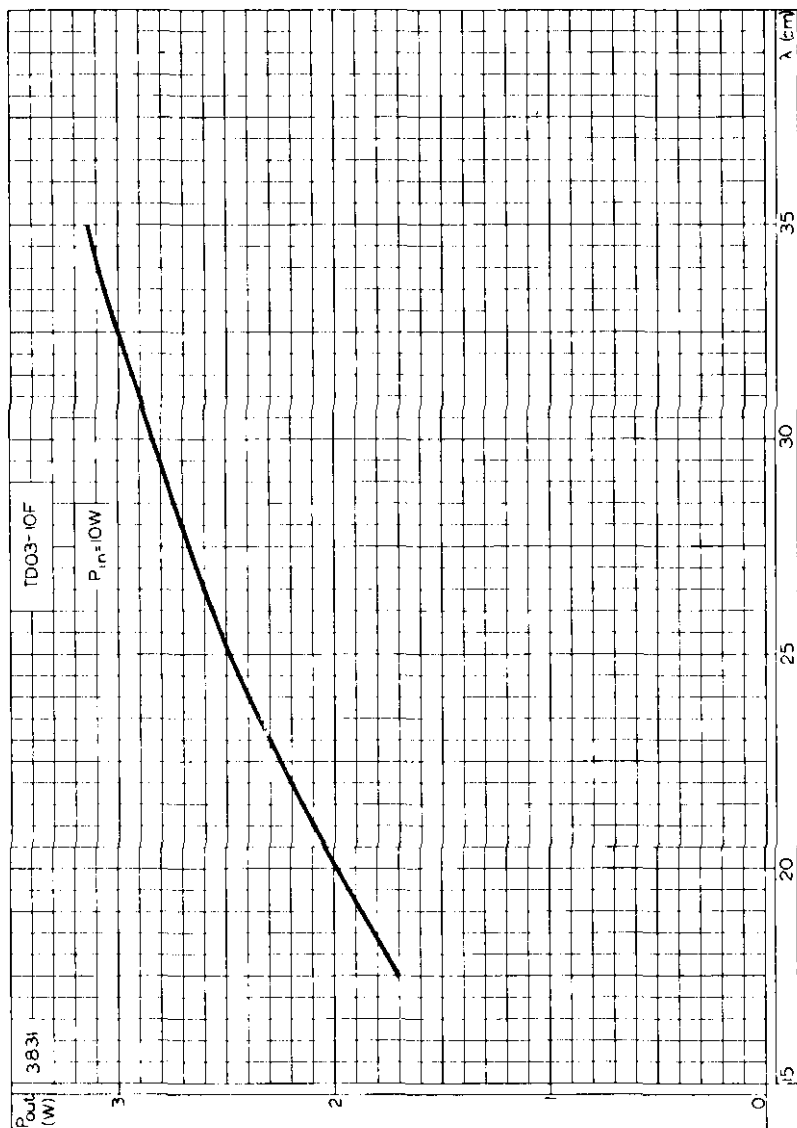

POWER OUTPUT PLOTTED AGAINST WAVELENGTH.



Application: R.F. amplifier or oscillator.
 Power output: 13.5W at $f = 1.0\text{Gc/s}$.
 Construction: Disc seal, natural cooling.

This data should be read in conjunction with GENERAL OPERATIONAL RECOMMENDATIONS – TRANSMITTING VALVES included in this volume of the handbook.

CATHODE

Indirectly heated

V_h	6.3	V
I_h	1.0	A

MOUNTING POSITION

Any

CAPACITANCES

$C_a - g$	2.3	pF
$C_a - k$	50	mpF
$C_g - k$	5.0	pF

CHARACTERISTICS

V_a	400	V
I_a	50	mA
g_{in}	10	mA/V
μ	28	

LIMITING VALUES

V_R max.	400	V
p_b max.	20	W
I_b max.	150	mA
$I_{k(pk)}$ max.	600	mA
p_g max.	1.0	W
$T_{\text{anode seal}}$ max.	140	°C

In order to limit the anode seal temperature and also to limit the rate of change of temperature it is necessary that the mass of metal in close thermal contact with the anode disc should not be less than 120g (approx. 4 oz) of brass or its thermal equivalent.

DIMENSIONS

	<i>Inches</i>	<i>Millimetres</i>	
A	1.252 ± 0.020	31.8 ± 0.5	
B	1.000 ± 0.010	25.4 ± 0.25	
C	*	*	
D	1.000	25.4	max.
E	0.902	22.9	max.
F	0.012 ± 0.002	0.3 ± 0.05	
G	1.772 ± 0.059	45.0 ± 1.5	
H	1.417 ± 0.039	36 ± 1	
J	0.465 ± 0.030	11.8 ± 0.75	
K	0.106	2.7	
L	0.280 ± 0.020	7.1 ± 0.5	
M	0.098	2.5	min.
N	0.299 ± 0.059	7.6 ± 1.5	
P	0.156 ± 0.004	3.96 ± 0.1	
Q	0.375 ± 0.015 -0.000	9.53 ± 0.38 -0.00	
R	*	*	
S	1.000 ± 0.010	25.4 ± 0.25	
T	1.275	32.39	min.
U	1.063 ± 0.005	27.00 ± 0.13	
V	0.630 ± 0.010	16.00 ± 0.25	
W	0.354 ± 0.010	8.99 ± 0.25	
X	1.000	25.40	
Y	0.453 ± 0.010	11.51 ± 0.25	
Z	0.375	9.53	
AA	1.063	27.00	
BB	1.260 ± 0.010	32.00 ± 0.25	
CC	1.535 ± 0.010	38.99 ± 0.25	
DD	0.156	3.96	
EE	0.031	0.79	
FF	0.031	0.79	
GG	0.094	2.39	
HH	0.500	12.70	
JJ	0.031	0.79	
KK	0.406	10.31	min.
LL	0.250	6.35	

*To fit inside a cylinder 24.13mm (0.950 in) diameter, co-axial with the anode disc.

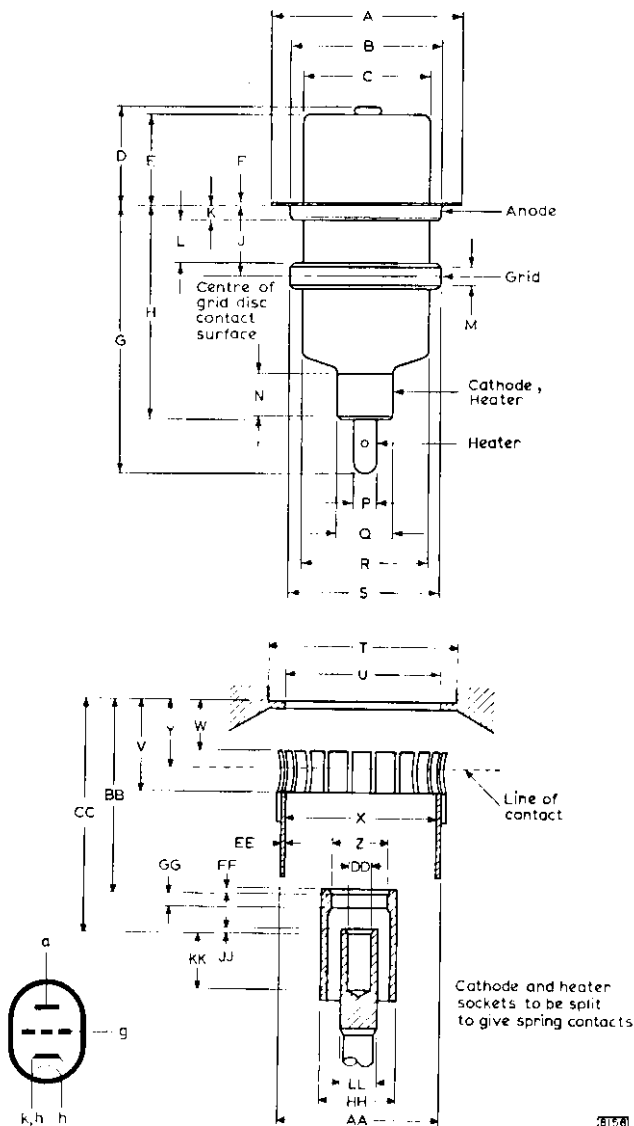

6156

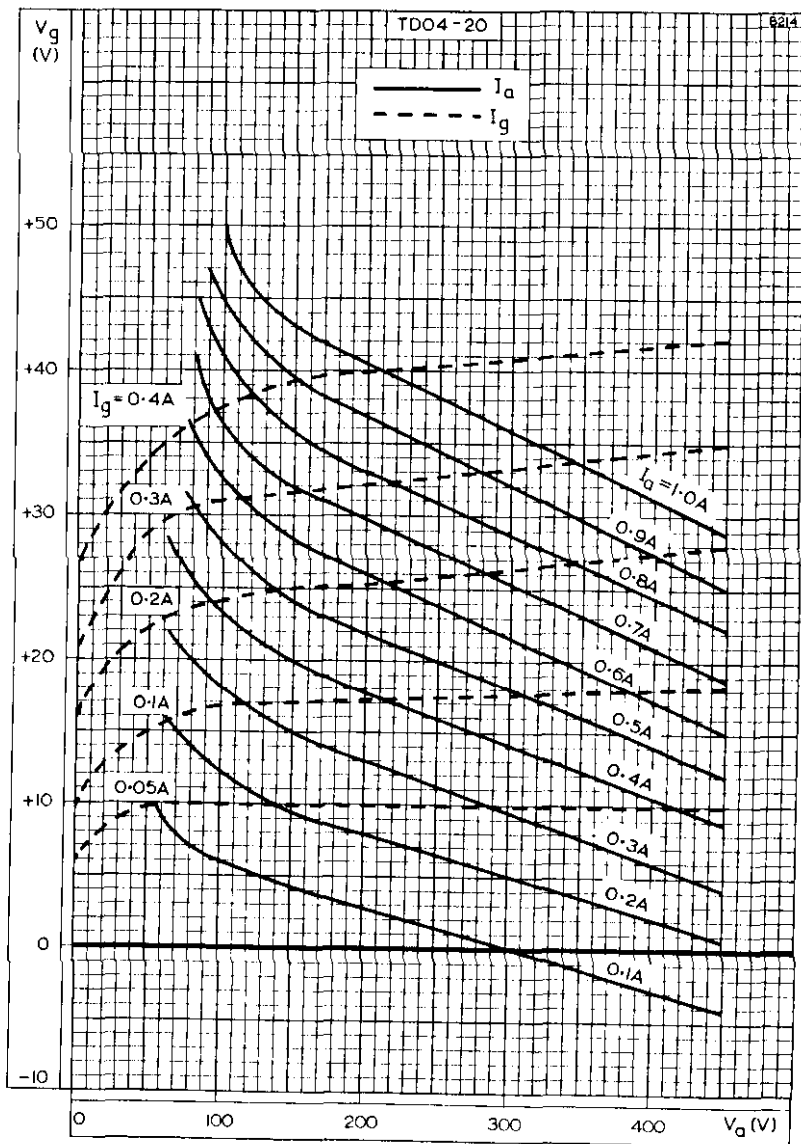

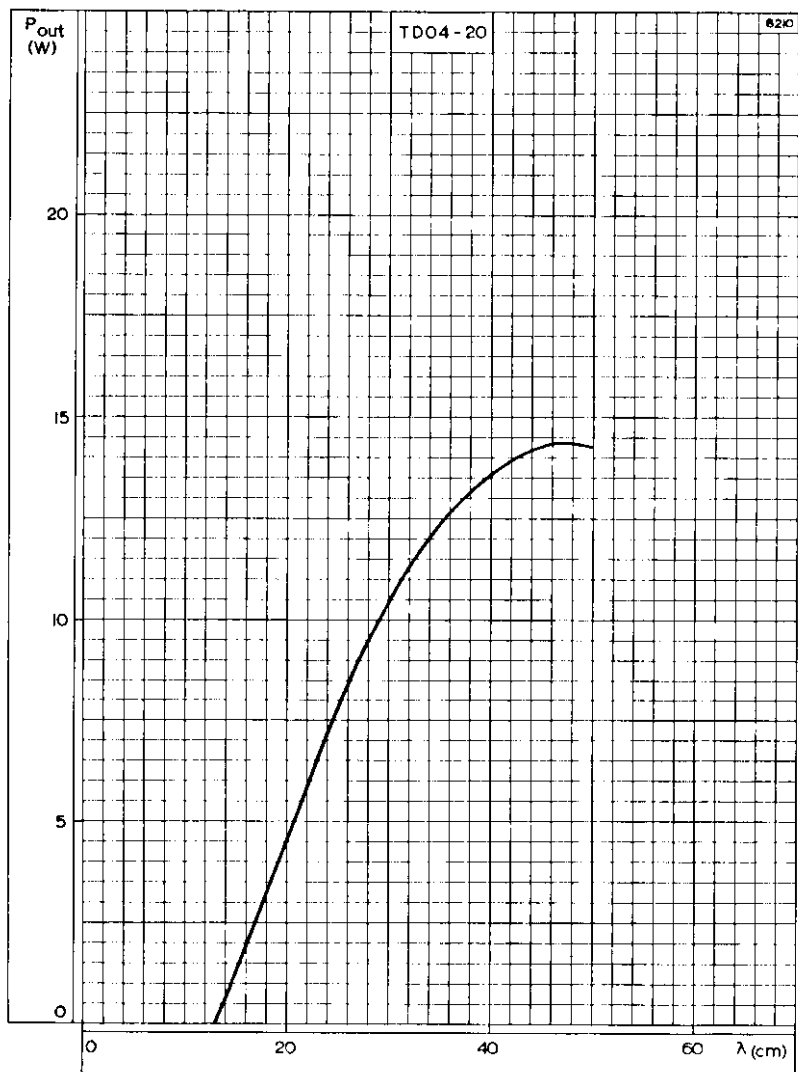

OUTPUT POWER PLOTTED AGAINST WAVELENGTH AS A COMMON GRID OSCILLATOR

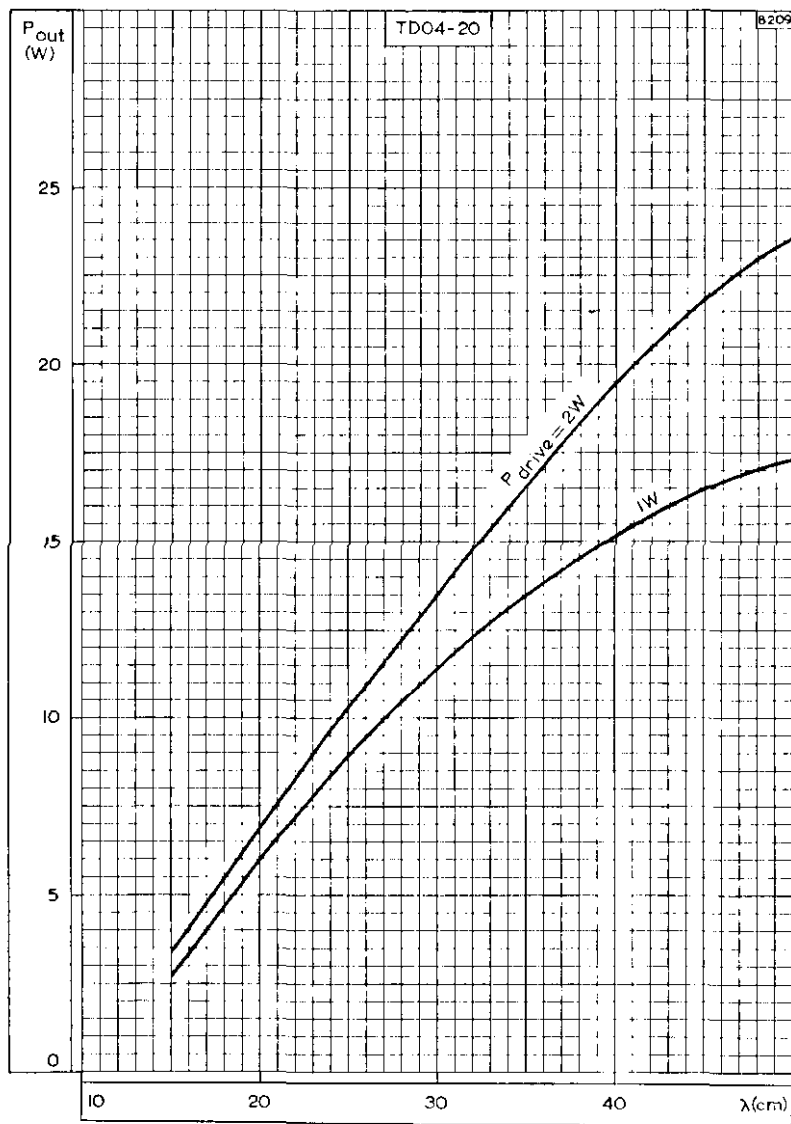

OUTPUT POWER PLOTTED AGAINST WAVELENGTH AS A
COMMON GRID AMPLIFIER

DISC SEAL TRIODE

TD2-400A

Application: R.F. oscillator, amplifier or frequency multiplier.

Power output: 600W at $f=470\text{Mc/s}$.

Frequency: 470Mc/s at full ratings, 900Mc/s at reduced ratings.

Construction: Disc seal, ceramic envelope, forced-air cooled.

This data should be used in conjunction with GENERAL OPERATIONAL RECOMMENDATIONS—TRANSMITTING VALVES included in this volume of the handbook.

FILAMENT

Thoriated tungsten

V_f ($f < 600\text{Mc/s}$)	3.4	V
I_f	19	A

The TD2-400A operates at frequencies where transit time effects cause back bombardment heating of the cathode. At frequencies higher than 600Mc/s the filament voltage must be reduced immediately after operation commences, in accordance with the following table:—

f (Mc/s)	V_f (V)
< 600	3.4
600 to 750	3.3
750 to 900	3.2

MOUNTING POSITION Vertical, anode up or down

CAPACITANCES

C_{a-g}	6.5	pF
C_{g-f}	11.5	pF
C_{a-f}	120	mpF

CHARACTERISTICS

V_a	2.0	kV
I_a	200	mA
V_g	-40	V
μ	33	

COOLING

Forced air

$T_{\text{anode seal max.}}$	250	°C
$T_{\text{grid seal max.}}$	250	°C
$T_{\text{filament seal max.}}$	200	°C

At all values of anode dissipation and frequencies forced-air cooling of the seals is necessary to ensure that the maximum seal temperatures are not exceeded. Typical values of inlet temperature, rate of flow of air, and pressure difference between the inlet and outlet of the housing are given in the following table:—

Anode dissipation P_{a} (W)	Height above sea level h (km) (ft)	Max. inlet temperature T_{in} (°C)	Min. rate of flow of air per minute (m^3) (ft^3)	Pressure difference between inlet and outlet (mm of (in. of water) water)
400	0 0	45	0.65 23	12 0.47
400	1500 4920	35	0.65 23	12 0.47
400	3000 9840	25	0.65 23	12 0.47

CLASS 'C' TELEGRAPHY OR F.M. TELEPHONY

Limiting values (absolute ratings)

f max.	470	600	900	Mc/s
V_a max.	2.2	2.1	2.1	kV
p_a max.		400		W
I_k max.		520		mA
$i_{k(pk)}$ max.		2.7		A
$-V_g$ max.		300		V
I_g max.		120		mA
R_{g-f} max.		10		k Ω

Typical operation (grounded grid)

f	470	640	730	810	Mc/s
V_a	2.0	1.8	1.8	1.8	kV
I_a	400	400	400	400	mA
V_g	-140	-120	-120	-120	V
I_g	120	100	100	100	mA
$P_{load(driver)}$	120	105	105	105	W
p_a	290	310	340	392	W
r_{rA}	63.5	57	53	45.5	%
* P_{out}	510+85	410+80	380+80	328+80	W
$P_{load}(r_{transfer} = 80\%)$	476	392	368	330	

*Includes power transferred from driver stage.

CLASS 'C' OSCILLATOR FOR R.F. INDUSTRIAL HEATING

Anode supply from transformer without intermediate rectifier

Limiting values (absolute ratings)

f max.		470	Mc/s
$V_{tr(r.m.s.)}$ max.		2.0	kV
p_a max.		170	W
I_k max.		295	mA
$i_{k(pk)}$ max.		2.3	A
$-V_g$ max.		300	V
I_g max.		85	mA
R_{g-f} max.		5.0	k Ω

Typical operation (grounded grid)

f	470	Mc/s
$V_{tr(r.m.s.)}$	1.8	kV
I_a	190	mA
I_g	70	mA
R_{g-f}	400	Ω
P_a	150	W
η_a	60	%

$P_{load} (0.85 P_{out} - P_{drive})$	160	W
---------------------------------------	-----	---

CLASS 'C' OSCILLATOR FOR R.F. INDUSTRIAL HEATING

With d.c. anode supply

Limiting values (absolute ratings)

f max.	470	900	Mc/s
V_a max.	2.2	2.0	kV
P_a max.		400	W
I_a max.		200	mA
I_g max.		120	mA
R_{g-f} max.		10	k Ω

Typical operation

f	470	810	Mc/s
V_a	2.0	1.8	kV
I_a	380	380	mA
* I_g	110	110	mA
R_{g-f}	1.0	1.0	k Ω
P_a	280	400	W
η_a	63	41	%
P_{out}	480	284	W
$P_{load} (0.85 P_{out} - P_{drive})$	340	200	W

*Using a current stabilising device as the grid resistance.

WEIGHT

Valve only	{	5.5	oz
		157	g
Shipping weight	{	9.0	oz
		250	g

DIMENSIONS

	<i>Inches</i>	<i>Millimetres</i>		
A	1.433 ± 0.008	36.4 ± 0.2		
B	1.0 ± 0.008	25.4 ± 0.2		
C	0.354 ± 0.008	9.0 ± 0.2		
D	1.626 ± 0.008	41.3 ± 0.2		
E	0.472	12		
F	0.236	6.0		
G	0.669 ± 0.020	17 ± 0.5		
H	0.925 ± 0.039	23.5 ± 1.0		
J	0.158	4.0		
K	0.551 ± 0.020	14 ± 0.5		
L	3.268	83	max.	←
M	1.024	26		
N	0.158	4.0		←
O	4 millimetre metric thread			←

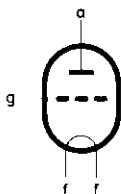
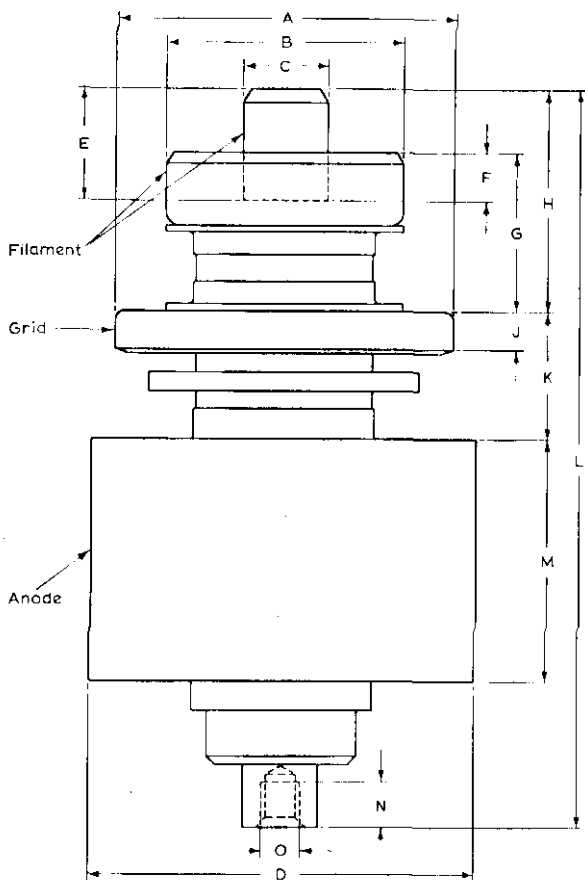

6119

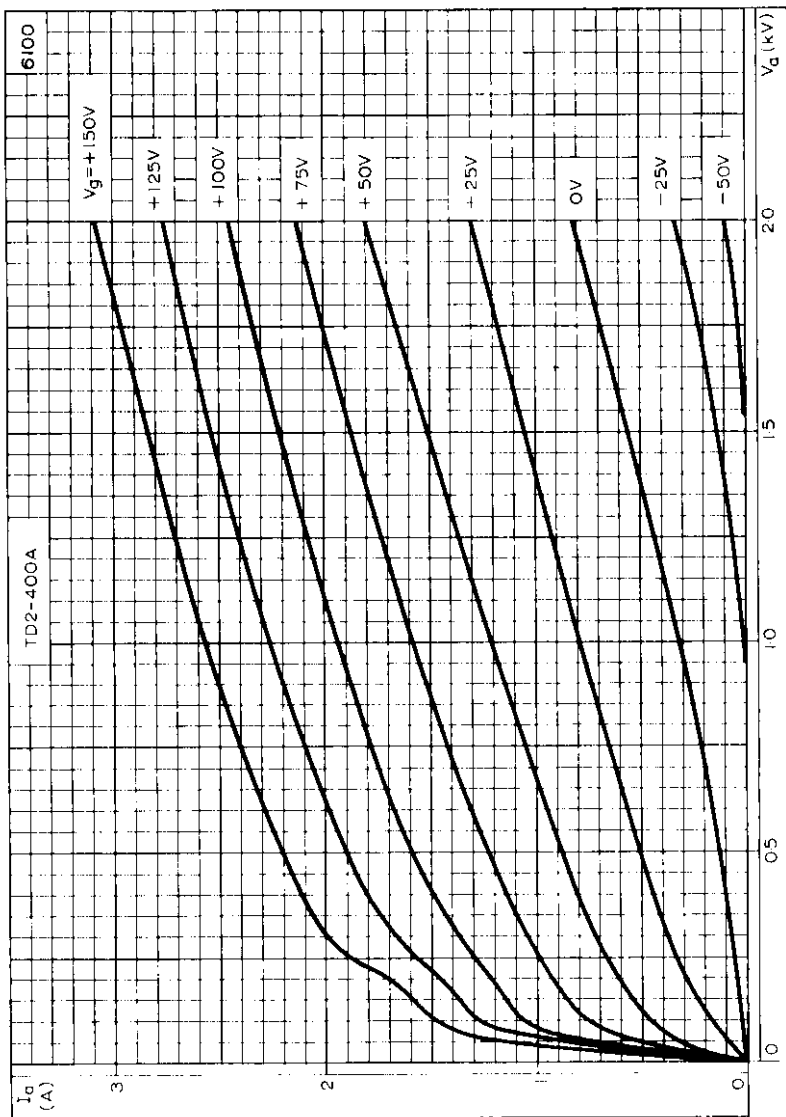

ANODE CURRENT PLOTTED AGAINST ANODE VOLTAGE WITH GRID VOLTAGE AS PARAMETER

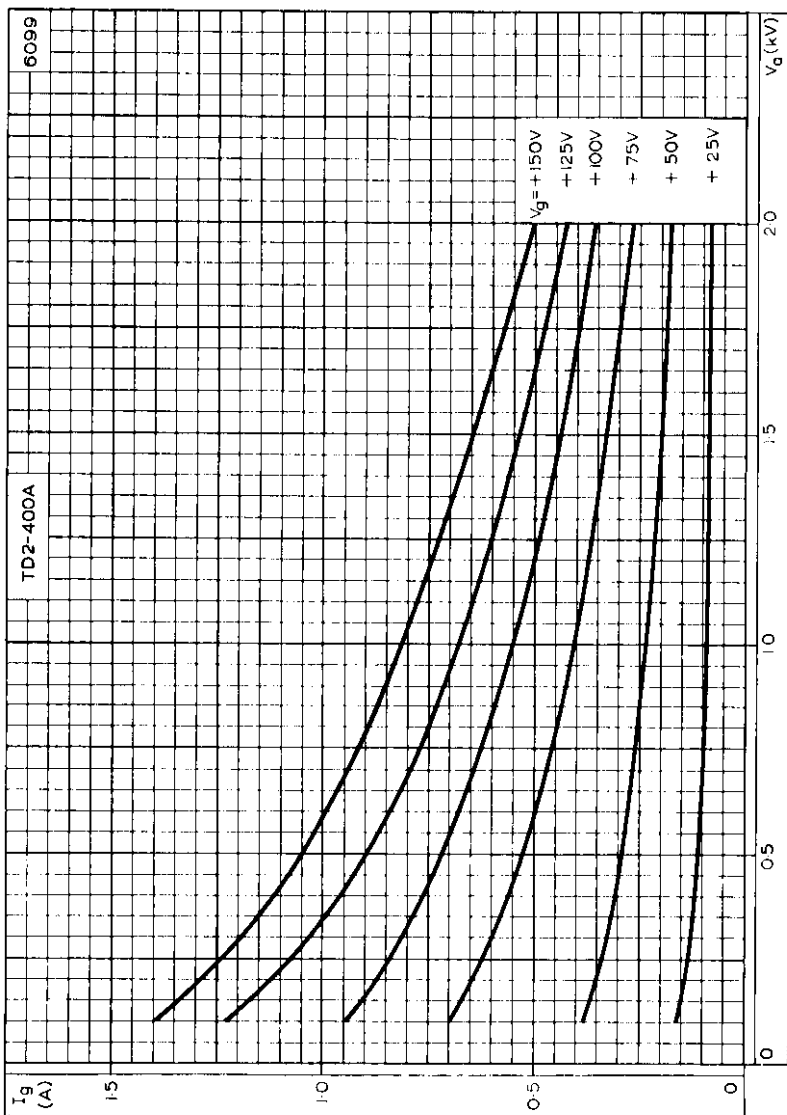

GRID CURRENT PLOTTED AGAINST ANODE VOLTAGE WITH GRID VOLTAGE AS PARAMETER

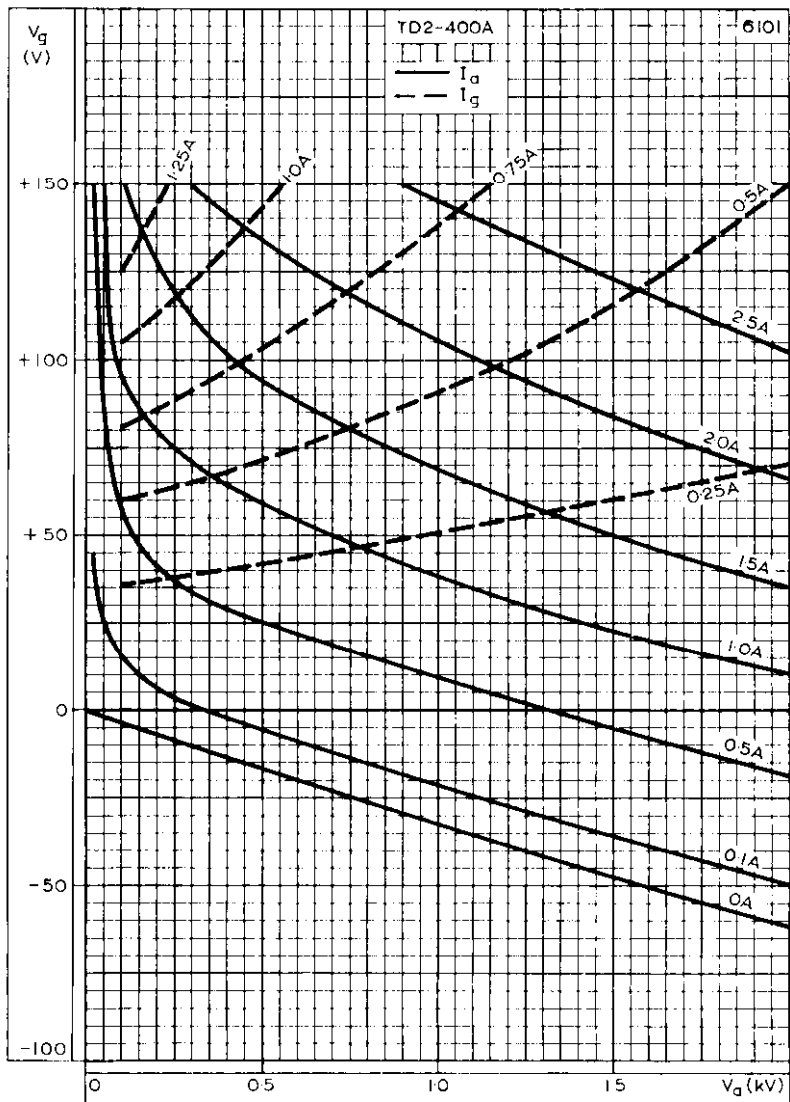

CONSTANT CURRENT CURVES

QUICK REFERENCE DATA

Disc seal triode with ceramic envelope intended for use as a power amplifier, oscillator or frequency multiplier.

f	400	625	Mc/s
P_{out}	670	580	W
$f_{max.}$	400	625	940
$V_a_{max.}$	2.7	2.5	2.0
$p_a_{max.}$	500	500	500
			W

To be read in conjunction with
GENERAL OPERATIONAL RECOMMENDATIONS - TRANSMITTING VALVES

CLASS 'C' TELEGRAPHY OR F.M. TELEPHONY

Maximum operating conditions for valve in common grid circuit amplifier

f	400	625	Mc/s
* P_{out}	620+50	533+47	W
P_{load}	470	405	W
η_a	64	64	%
V_a	2.5	2.5	kV
I_a	380	380	mA
V_g	70	60	V
I_g	160	170	mA
P_{load} (driver)	70	65	W
p_a	330	302	W

*Includes power transferred from driver stage.

ABSOLUTE MAXIMUM RATINGS

f max.	400	625	940	Mc/s
V_a max.	2.7	2.5	2.0	kV
V_g max.	300	300	300	V
I_k max.	575	575	560	mA
p_a max.	500	500	500	W

CATHODE

Directly heated, thoriated tungsten.

At frequencies higher than 600Mc/s, transit time causes back bombardment heating of the cathode. The filament voltage must be reduced immediately after operation commences in accordance with the following table:-

f (Mc/s)	V_f (V)
< 600	3.4
600 to 750	3.2

I_f (at $V_f = 3.4V$)	19	A
--------------------------	----	---

CAPACITANCES

c_{a-f}	50	mpF
c_{g-f}	11	pF
c_{a-g}	3.8	pF

CHARACTERISTICS (measured at $V_a = 2.0kV$, $I_a = 240mA$)

g_m	14	mA/V
μ	70	

MOUNTING POSITION

Vertical with anode up or down.



COOLING

Forced air

Maximum temperature

Seals 200 °C

The amount of forced-air cooling required for this valve depends upon the anode dissipation and the height above sea level. Typical values of inlet temperature, rate of flow of air and pressure difference between the inlet and outlet of the housing are given in the following table:-

Anode dissipation	Height above sea level		Max. inlet temperature	Min. rate of flow of air per minute		Pressure difference between inlet and outlet	
	P_a (W)	h (km) (ft)		T_{in} (°C)	(m ³) (ft ³)	(mm of water)	(inches of water)
500	0	0	45	0.9 32	24	0.94	
500	1.5	4 920	35	0.9 32	20	0.79	
500	3.0	9 840	25	1.0 35	21	0.83	

PHYSICAL DATA

	oz	g
Weight of valve	6.0	170
Weight of valve plus carton	9.0	255

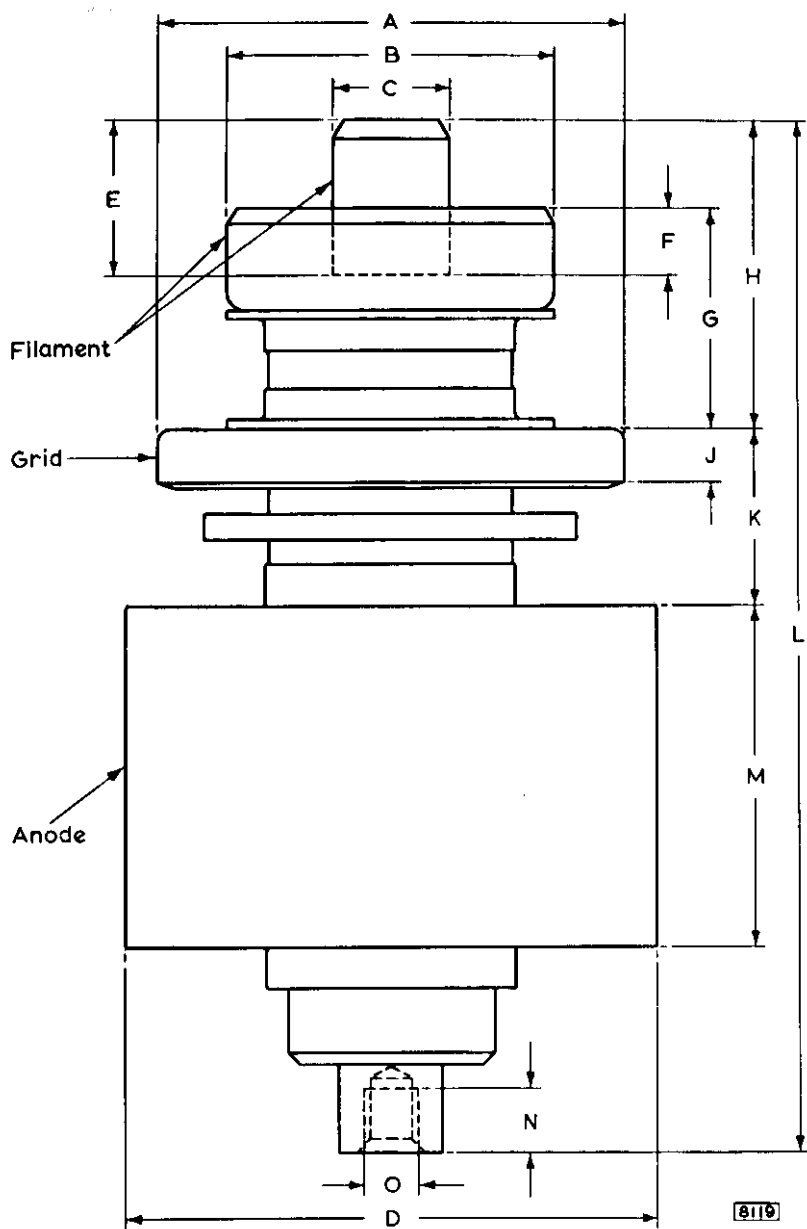

DIMENSIONS

	Inches	Millimetres	
A	1.433 ± 0.008	36.4 ± 0.2	
B	1.0 ± 0.008	25.4 ± 0.2	
C	0.354 ± 0.008	9.0 ± 0.2	
D	1.626 ± 0.008	41.3 ± 0.2	
E	0.48	12	min.
F	0.236	6.0	
G	0.669 ± 0.020	17 ± 0.5	
H	0.925 ± 0.039	23.5 ± 1.0	
J	0.158 ± 0.020	4.0 ± 0.5	
K	0.551 ± 0.020	14 ± 0.5	
L	3.26	83	max.
M	1.02	26	
N	0.158	4.0	
O	4 millimetre metric thread		

Inch dimensions derived from original millimetre dimensions

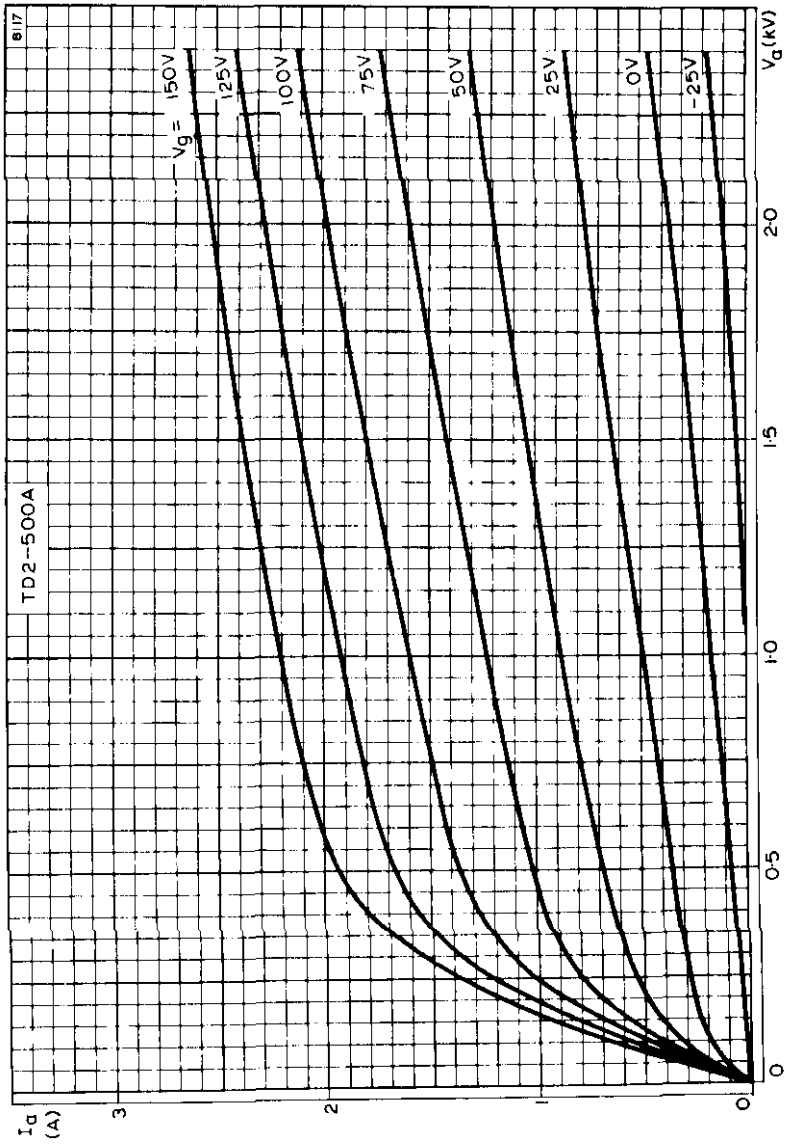

ANODE CURRENT PLOTTED AGAINST ANODE VOLTAGE WITH GRID VOLTAGE AS PARAMETER



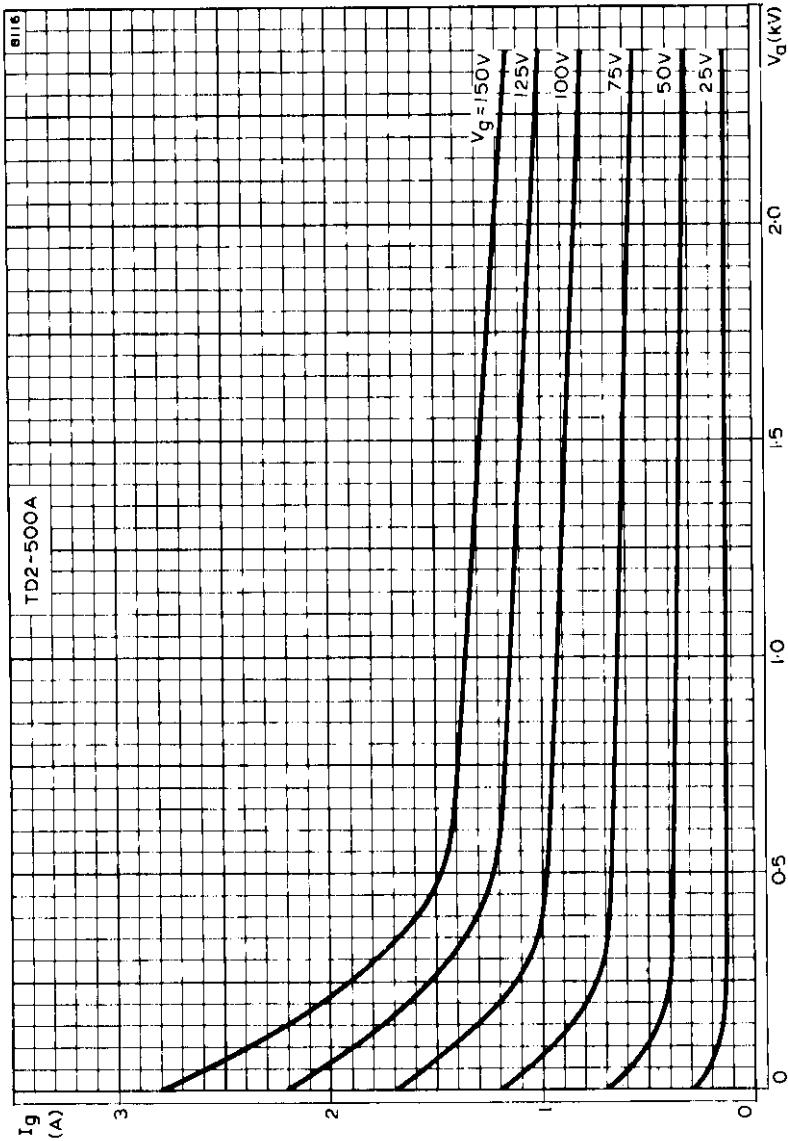

GRID CURRENT PLOTTED AGAINST ANODE VOLTAGE WITH GRID VOLTAGE AS PARAMETER

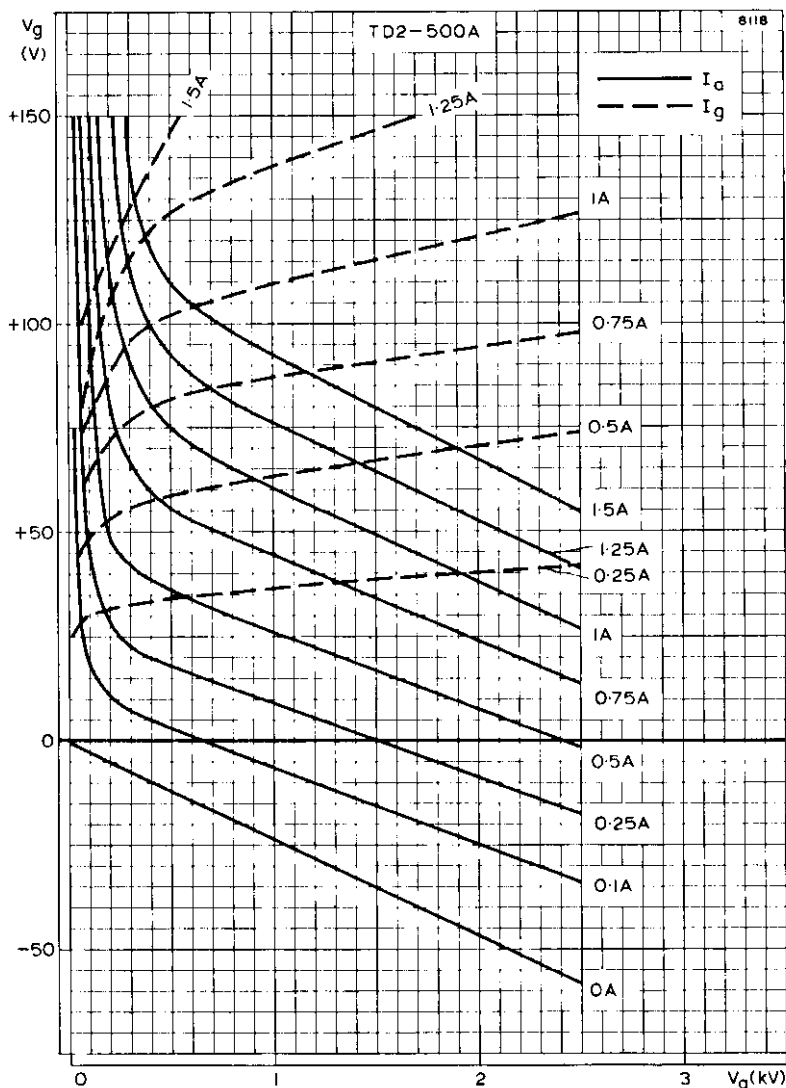

CONSTANT CURRENT CHARACTERISTICS