



Optical Networks

Definition

Optical networks are high-capacity telecommunications networks based on optical technologies and components that provide routing, grooming, and restoration at the wavelength level as well as wavelength-based services.

Overview

As networks face increasing bandwidth demand and diminishing fiber availability, network providers are moving towards a crucial milestone in network evolution: the optical network. Optical networks, based on the emergence of the optical layer in transport networks, provide higher capacity and reduced costs for new applications such as the Internet, video and multimedia interaction, and advanced digital services.

As with any new technology, many questions arise. How is the optical network different from existing networks? What are the network elements required for optical networks? What applications do optical networks best suit? This tutorial will address all of these questions and explain the technologies, architectures, and market trends for emerging optical networks.

Topics

1. Benefit and History of Optical Networks
2. Optical-Network Drivers
3. Enabling Technologies
4. Technologies On the Horizon
5. Component Applications
6. Markets for Optical Networks
7. Design and Planning
8. Restoration
9. Network Management
10. Network Evolutions: Part I
11. Network Evolutions: Part II

12. The Future of Optical Networks

Self-Test

Correct Answers

Glossary

1. Benefits and History of Optical Networks

In the early 1980s, a revolution in telecommunications networks began that was spawned by the use of a relatively unassuming technology, fiber-optic cable. Since then, the tremendous cost savings and increased network quality has led to many advances in the technologies required for optical networks, the benefits of which are only beginning to be realized.

History

Telecommunication networks have evolved during a century-long history of technological advances and social changes. The networks that once provided basic telephone service through a friendly local operator are now transmitting the equivalent of thousands of encyclopedias per second. Throughout this history, the digital network has evolved in three fundamental stages: asynchronous, synchronous, and optical.

Asynchronous

The first digital networks were asynchronous networks. In asynchronous networks, each network element's internal clock source timed its transmitted signal. Because each clock had a certain amount of variation, signals arriving and transmitting could have a large variation in timing, which often resulted in bit errors.

More importantly, as optical-fiber deployment increased, no standards existed to mandate how network elements should format the optical signal. A myriad of proprietary methods appeared, making it difficult for network providers to interconnect equipment from different vendors.

Synchronous

The need for optical standards led to the creation of the synchronous optical network (SONET). SONET standardized line rates, coding schemes, bit-rate hierarchies, and operations and maintenance functionality. SONET also defined the types of network elements required, network architectures that vendors could

implement, and the functionality that each node must perform. Network providers could now use different vendor's optical equipment with the confidence of at least basic interoperability.

Optical

The one aspect of SONET that has allowed it to survive during a time of tremendous changes in network capacity needs is its scalability. Based on its open-ended growth plan for higher bit rates, theoretically no upper limit exists for SONET bit rates. However, as higher bit rates are used, physical limitations in the laser sources and optical fiber begin to make the practice of endlessly increasing the bit rate on each signal an impractical solution. Additionally, connection to the networks through access rings has also had increased requirements. Customers are demanding more services and options and are carrying more and different types of data traffic. To provide full end-to-end connectivity, a new paradigm was needed to meet all the high-capacity and varied needs. Optical networks provide the required bandwidth and flexibility to enable end-to-end wavelength services (see *Figure 1*).

Figure 1. End-to-End Wavelength Services

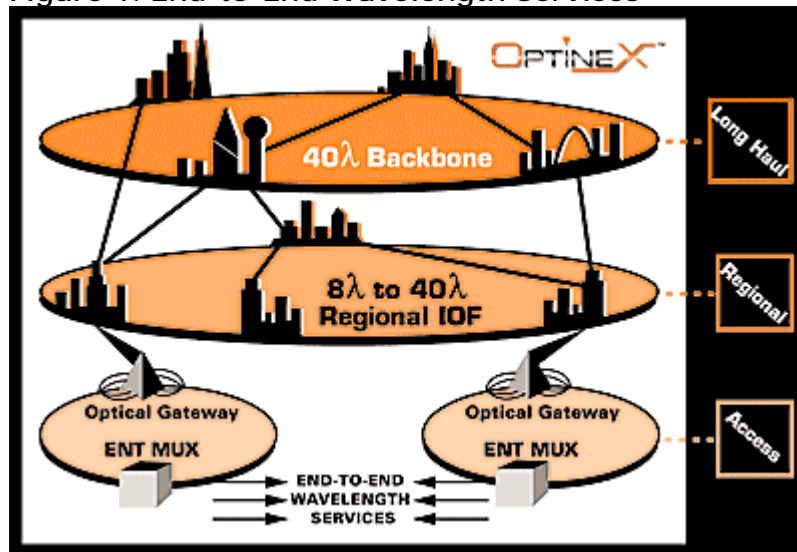

Optical networks began with wavelength division multiplexing (WDM), which arose to provide additional capacity on existing fibers. Like SONET, defined network elements and architectures provide the basis of the optical network. However, unlike SONET, rather than using a defined bit-rate and frame structure as its basic building block, the optical network will be based on wavelengths. The components of the optical network will be defined according to how the wavelengths are transmitted, groomed, or implemented in the network. Viewing the network from a layered approach, the optical network requires the addition of an optical layer. To help define network functionality, networks are divided into

several different physical or virtual layers. The first layer, the services layer, is where the services—such as data traffic—enter the telecommunications network. The next layer, SONET, provides restoration, performance monitoring, and provisioning that is transparent to the first layer.

Emerging with the optical network is a third layer, the optical layer. Standards bodies are still defining the optical layer, but it will eventually provide the same functionality as the SONET layer, while operating entirely in the optical domain. The optical network also has the additional requirement of carrying varied types of high bit-rate nonSONET optical signals that bypass the SONET layer altogether. Just as the SONET layer is transparent to the services layer, the optical layer will ideally be transparent to the SONET layer, providing restoration, performance monitoring, and provisioning of individual wavelengths instead of electrical SONET signals.

2. Optical-Network Drivers

Many factors are driving the need for optical networks. A few of the most important reasons for migrating to the optical layer are described in this module.

Fiber Capacity

The first implementation of what has emerged as the optical network began on routes that were fiber limited. Providers needed more capacity between two sites, but higher bit rates or fiber were not available. The only options in these situations were to install more fiber, which is an expensive and labor-intensive chore, or place more time division multiplexed (TDM) signals on the same fiber. WDM provided many virtual fibers on a single physical fiber. By transmitting each signal at a different frequency, network providers could send many signals on one fiber just as though they were each traveling on their own fiber.

Restoration Capability

As network planners use more network elements to increase fiber capacity, a fiber cut can have massive implications. In current electrical architectures, each network element performs its own restoration. For a WDM system with many channels on a single fiber, a fiber cut would initiate multiple failures, causing many independent systems to fail. By performing restoration in the optical layer rather than the electrical layer, optical networks can perform protection switching faster and more economically. Additionally, the optical layer can provide restoration in networks that currently do not have a protection scheme. By implementing optical networks, providers can add restoration capabilities to embedded asynchronous systems without first upgrading to an electrical-protection scheme.

Reduced Cost

In systems using only WDM, each location that demultiplexes signals will need an electrical network element for each channel, even if no traffic is dropping at that site. By implementing an optical network, only those wavelengths that add or drop traffic at a site need corresponding electrical nodes. Other channels can simply pass through optically, which provides tremendous cost savings in equipment and network management. In addition, performing space and wavelength routing of traffic avoids the high cost of electronic cross-connects, and network management is simplified.

Wavelength Services

One of the great revenue-producing aspects of optical networks is the ability to resell bandwidth rather than fiber. By maximizing capacity available on a fiber, service providers can improve revenue by selling wavelengths, regardless of the data rate required. To customers, this service provides the same bandwidth as a dedicated fiber.

3. Enabling Technologies

The cornerstone of an optical network is the advanced optical technologies that perform the necessary all-optical functions. Optical technologies continue to advance by ingenious techniques and implementations to improve the performance and capabilities of the optical network (see *Figure 2*).

Figure 2. Development Milestones

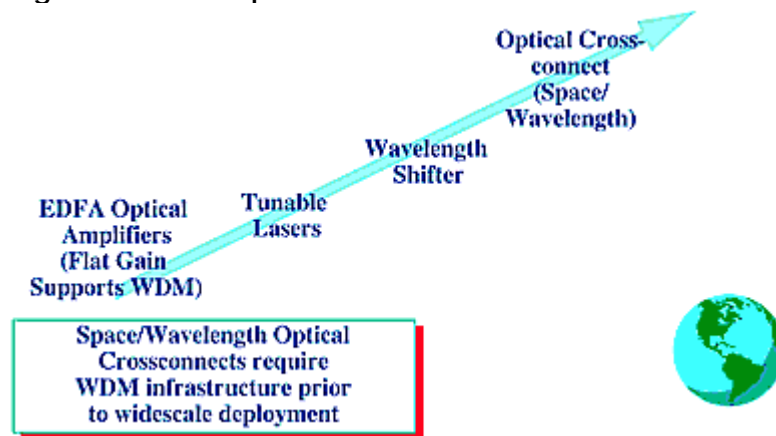

Early Technologies

As fiber optics came into use, network providers soon found that some improvements in technology could greatly increase capacity and reduce cost in existing networks. These early technologies eventually led to the optical network as it is today.

Broadband WDM

The first incarnation of WDM was broadband WDM. In 1994, by using fused biconic tapered couplers, two signals could be combined on the same fiber. Because of limitations in the technology, the signal frequencies had to be widely separated, and systems typically used 1,310-nm and 1,550-nm signals, providing 5 Gbps on one fiber. Although the performance did not compare to today's technologies, the couplers provided twice the bandwidth out of the same fiber, which was a large cost savings compared to installing new fiber.

Optical Amplifiers

The second basic technology, and perhaps the most fundamental to today's optical networks, was the erbium-doped optical amplifier. By doping a small strand of fiber with a rare earth metal, such as erbium, optical signals could be amplified without converting the signal back to an electrical state. The amplifier provided enormous cost savings over electrical regenerators, especially in long-haul networks.

Current Technologies

Systems deployed today use devices that perform similar functions to earlier devices but are much more efficient and precise. In particular, flat-gain optical amplifiers have been the true enabler for optical networks by allowing the combination of many wavelengths across a single fiber.

Dense Wavelength Division Multiplexing (DWDM)

As optical filters and laser technology improved, the ability to combine more than two signal wavelengths on a fiber became a reality. Dense wavelength division multiplexing (DWDM) combines multiple signals on the same fiber, ranging up to 40 or 80 channels. By implementing DWDM systems and optical amplifiers, networks can provide a variety of bit rates (i.e., OC-48 or OC-192), and a multitude of channels over a single fiber (see *Figure 3*). The wavelengths used are all in the range that optical amplifiers perform optimally, typically from about 1,530 nm to 1,565 nm (see *Figure 4*).

Figure 3. DWDM Systems and Optical Amplifiers

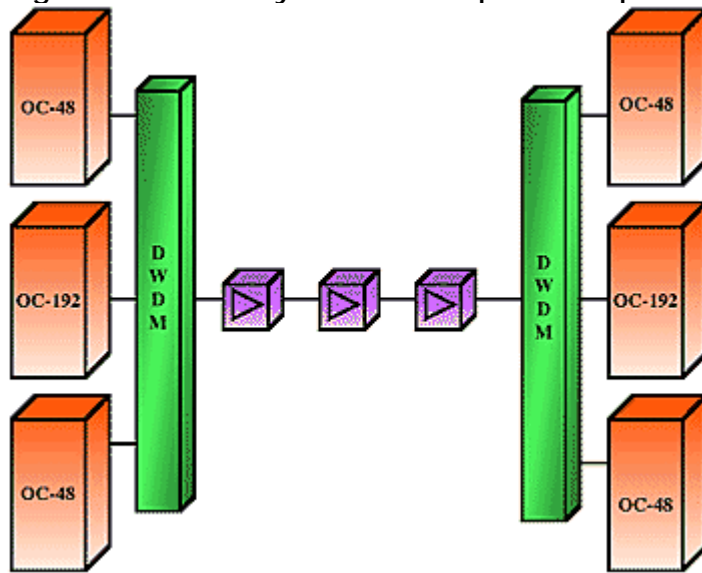
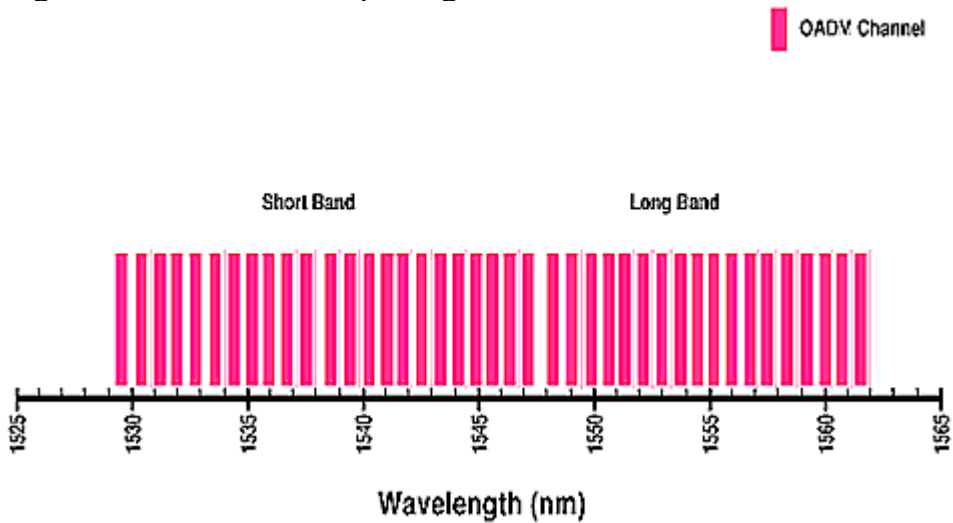
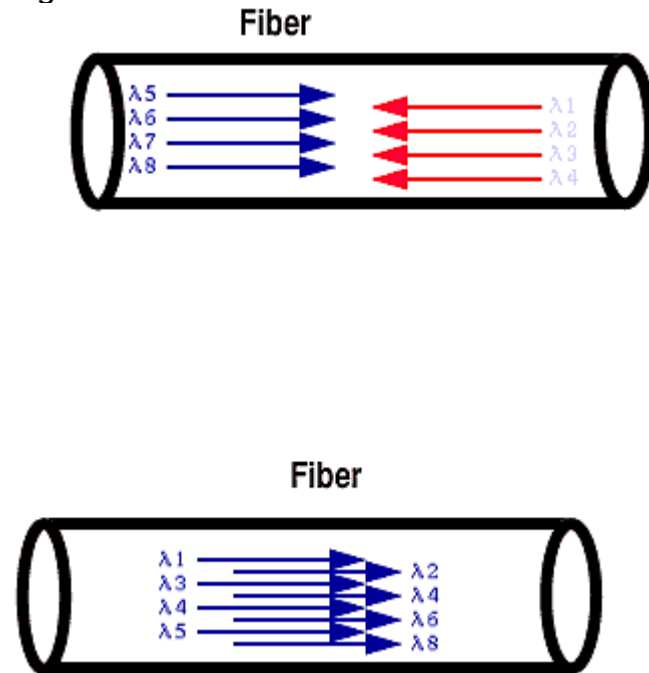

Figure 4. ITU Channel Spacing



Two basic types of DWDM are implemented today: unidirectional and bidirectional DWDM (see *Figure 5*). In a unidirectional system, all the wavelengths travel in the same direction on the fiber, while in a bidirectional system the signals are split into separate bands, with both bands traveling in different directions.

Figure 5. Unidirectional and Bidirectional DWDM



Optical Amplifiers

The performance of optical amplifiers has improved significantly—with current amplifiers providing significantly lower noise and flatter gain—which is essential to DWDM systems. The total power of amplifiers also has steadily increased, with amplifiers approaching +20-dBm outputs, which is many orders of magnitude more powerful than the first amplifiers.

Narrowband Lasers

Without a narrow, stable, and coherent light source, none of the optical components would be of any value in the optical network. Advanced lasers with narrow bandwidths provide the narrow wavelength source that is the individual channel in optical networks. Typically, long-haul applications use externally modulated lasers, while shorter applications can use integrated laser technologies.

These laser sources emit a highly coherent signal that has an extremely narrow bandwidth. Depending on the system used, the laser may be part of the DWDM system or embedded in the SONET network element. When the precision laser is embedded in the SONET network element, the system is called an embedded system. When the precision laser is part of the WDM equipment in a module called a transponder, it is considered an open system because any low-cost laser transmitter on the SONET network element can be used as input (see *Figure 6*).

Figure 6. Embedded vs. Open DWDM Systems

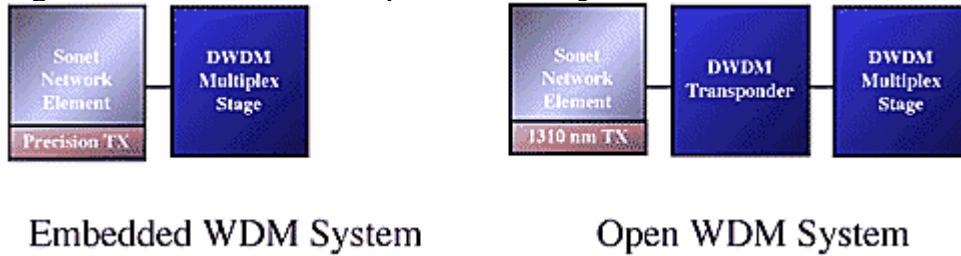

Fiber Bragg Gratings

Commercially available fiber Bragg gratings have been important components for enabling WDM and optical networks. A fiber Bragg grating is a small section of fiber that has been modified to create periodic changes in the index of refraction. Depending on the space between the changes, a certain frequency of light—the Bragg resonance wavelength—is reflected back, while all other wavelengths pass through (see *Figure 7*). The wavelength-specific properties of the grating make fiber Bragg gratings useful in implementing optical add/drop multiplexers. Bragg gratings also are being developed to aid in dispersion compensation and signal filtering as well.

Figure 7. In-Fiber Bragg Grating Technology: Optical A/D Multiplexer

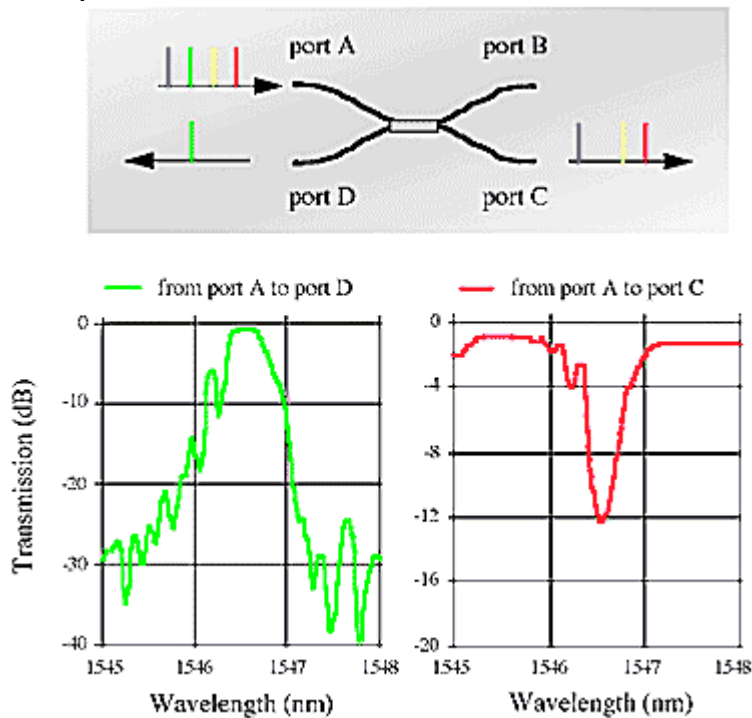

Thin Film Substrates

Another essential technology for optical networks is the thin film substrate. By coating a thin glass or polymer substrate with a thin interference film of dielectric material, the substrate can be made to pass through only a specific wavelength and reflect all others. By integrating several of these components, many optical network devices are created, including multiplexers, demultiplexers, and add/drop devices.

4. Technologies on the Horizon

Key functions have been identified as requirements for the emerging optical network (see *Figure 8*). As component technologies advance, each of the functions required, such as tunable filters, space switches, and wavelength converters, will become more cost effective and practical.

Figure 8. Key Functional Blocks for WDM Transport Systems

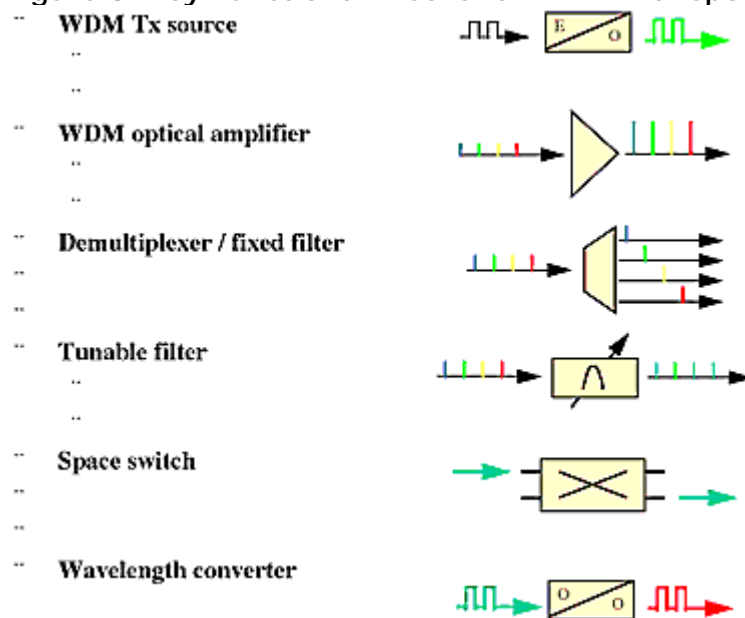

One of the most promising technologies for optical networks is the semiconductor optical amplifier (SOA). By integrating the amplifier functionality into the semiconductor material, the same basic component can perform many different applications (see *Figure 9*). SOAs can provide integrated functionality of internal switching and routing functions that are required for a feature-rich network. Space switches, wavelength converters, and wavelength selectors all can be made from SOAs, which will lead to large cost reductions and improved performance in future optical-network equipment (see *Figure 10*).

Figure 9. Semiconductor Optical Amplifier Technology

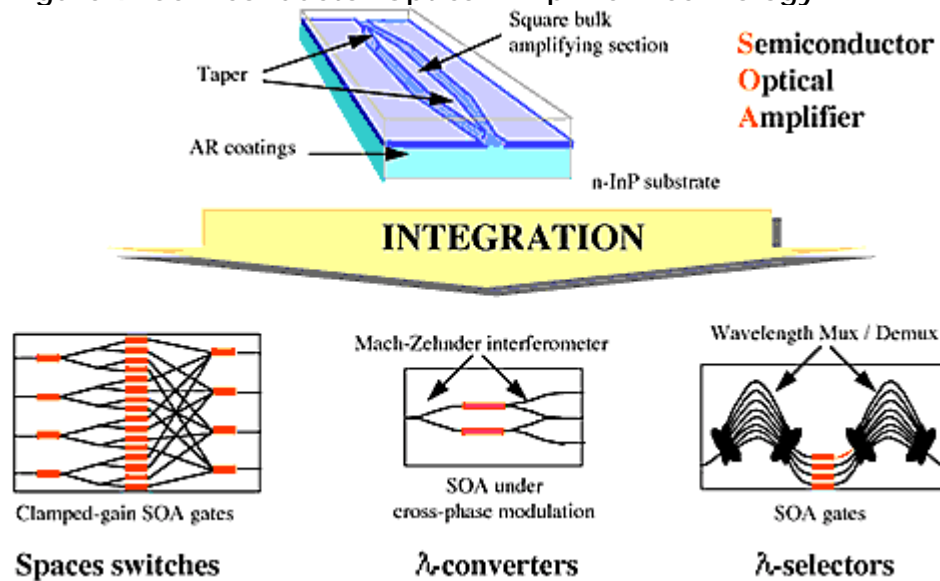
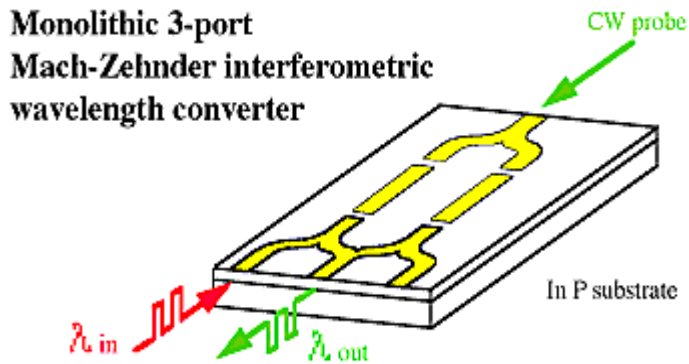
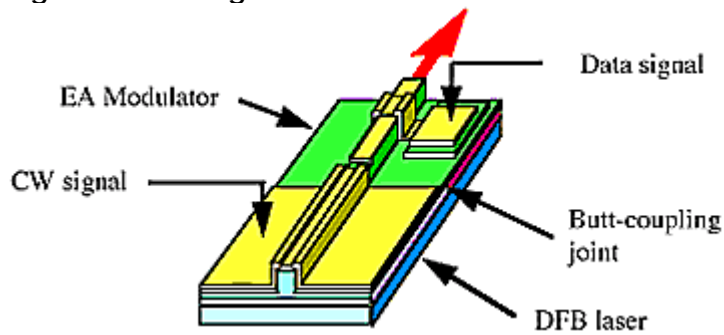

Figure 10. All-Optical Semiconductor Wavelength Converter



Promising new gain-switching technology makes possible optical-space switches, selectable filters, and wavelength converters. Today's transmission systems employ NRZ at OC-48 (2.5 Gbps) and OC-192 (10 Gbps) data rates. However, new transmission technologies are being studied to open the way to OC-768 (40 Gbps). These new systems might be based on either electronic time division multiplexing (ETDM) or optical time division multiplexing (OTDM) 4X10-Gbps technologies. Advances are being made with integrated laser modulators that provide lower-cost narrowband transmitters (see *Figure 11*).

Figure 11. Integrated Laser Modulator



Soliton transmission, first deployed in submarine links, might find application in terrestrial networks to improve transmission performance or in some types of all-optical signal processing such as 3R regeneration. Research dealing with polarization-mode dispersion mitigation, phase-shaped binary transmission (PSBT), and fiber-grating technologies promise significant advances in the near future with regard to increasing system performance and network capacity.

All of these technologies aim to reduce the network cost and provide valuable new services to customers who are constantly demanding more bandwidth-intensive and flexible features from their network providers.

5. Component Applications

Regardless of the component technologies that are implemented in the system, the optical network must perform several specific functions in order to achieve maximum efficiency.

Wavelength Add/Drop Multiplexers

The first element to be integrated into the optical network is the optical multiplexer. The multiplexer combines multiple wavelengths onto a single fiber, which allows all the signals to be routed along the same fiber. The initial application for multiplexers has been to increase capacity on existing fiber routes without adding more fiber, but they will serve as entry points to the optical layer in many more aspects, including add/drop multiplexers and optical cross-connects.

Wavelength Switches

The ability to switch individual wavelengths is crucial to maximizing the capacity and efficiency of optical networks. A wavelength switch provides functionality similar to an electrical switch by routing an incoming wavelength to a variety of physical output ports.

Wavelength Converters

The final element in optical networks is the wavelength converter, which converts an incoming signal's wavelength to a different outgoing wavelength, entirely in the optical domain. This will allow the network traffic to be groomed to optimize for traffic patterns or network architecture.

6. Markets for Optical Networks

The evolution to the optical layer in telecommunications networks will occur in stages in different markets because the traffic types and capacity demands for each are different. Overall, the growth is predicted to be enormous (see *Figure 12*). This module will review each potential market, including the main drivers for deploying optical networks, and issues that might arise.

Figure 12. Optical Networks Market (\$Millions)

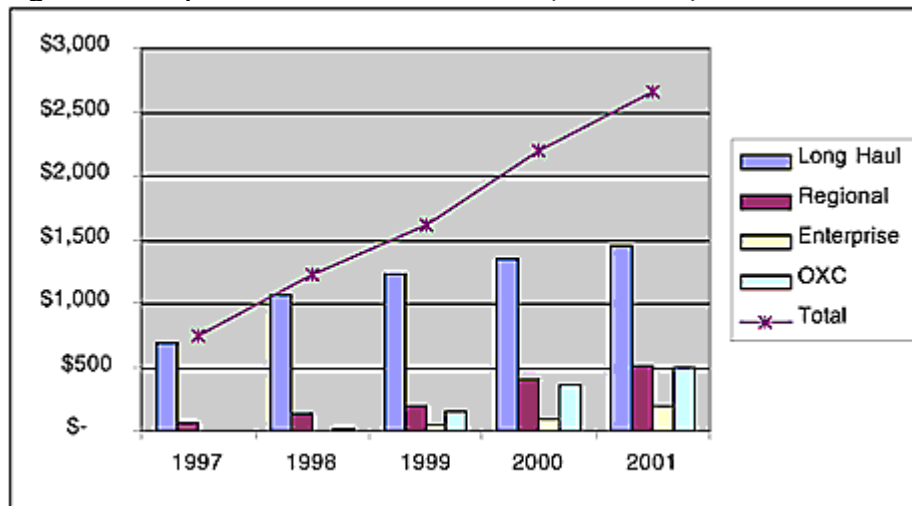

Long-Haul Networks

Nowhere else is bandwidth devoured so quickly as in the long-haul network. Spanning for thousands of miles in many cases, long-haul networks are different from all other markets in several important regards: long spans between nodes and extremely high bandwidth requirements.

Long-haul networks were the first to have large-scale deployment of optical amplifiers and wideband-WDM systems mainly because of cost reductions. Optical amplifiers are a cheaper alternative to a large number of electrical regenerators in a span. In addition, using WDM, interexchange carriers increased the fiber capacity by using WDM, which avoids the large expenditures of installing new fiber.

Metro Interoffice (IOF) Networks

Networks in the metro interoffice (IOF) market have different needs for optical technologies. IOF networks are typically more interconnected and geographically localized. Because of the traffic patterns and distances between offices, optical rings and optical cross-connects will be required much earlier. IOF networks not only need to distribute traffic throughout a region, but also must connect to the long-haul network. As the optical network evolves, wavelength add/drop and interconnections will add the flexibility and value that IOF networks require.

Business-Access Networks

The last mile of the network to business customers has gone by many names: wide-area networks (WANs), metropolitan-area networks (MANs), and business-access networks. Regardless of the name, these networks provide businesses with connections to the telecommunications infrastructure. It is these networks where the application of optical networks is not so clear. Many more complexities arise in these networks, including variable bit-rate interfaces, different cost structures, and different capacity needs. Similar in architecture to IOF networks, business-access network sites are much closer together, so fiber amplification is not as important.

An important component for optical networks in business-access networks is the asynchronous transponder, which allows a variety of bit-rate signals to enter the optical network. Optical networks designed for the business access environment will need to incorporate lower-cost systems to be cost effective and enable true wavelength services. The challenge will be proving when and where DWDM is effective in access networks.

7. Design and Planning

One of the largest challenges facing network planners who are implementing optical networks is the task of designing and planning the optical layer. Only when providers begin to plan the optical network do some of the more intricate and difficult issues arise.

Span Designs

Ideally, the optical network will provide end-to-end services entirely in the optical domain, without ever converting signals into electrical format. Unfortunately, for at least a decade, it is probable that technology will not progress to the point that it is possible to transmit signals for long distances without electrical regeneration. Even as optical regenerators become

commercially viable, network spans will still need to be designed to maintain signal quality throughout the entire signal path.

Planners must design optical networks so that signals traveling on the fiber between one network element site and another, called a span, maintain their quality. Many factors must be taken into account, including the optical signal-to-noise ratio (OSNR) (see *Figure 13*), chromatic dispersion (see *Figure 14*), and a myriad of nonlinear effects introduced by the interaction of the fiber with the optical signal. The challenge of designing optical networks increases with the introduction of optical cross-connects and add/drop multiplexers, which could dynamically change a signal path to travel across a different physical route.

Figure 13. Optical Signal to Noise Ratio

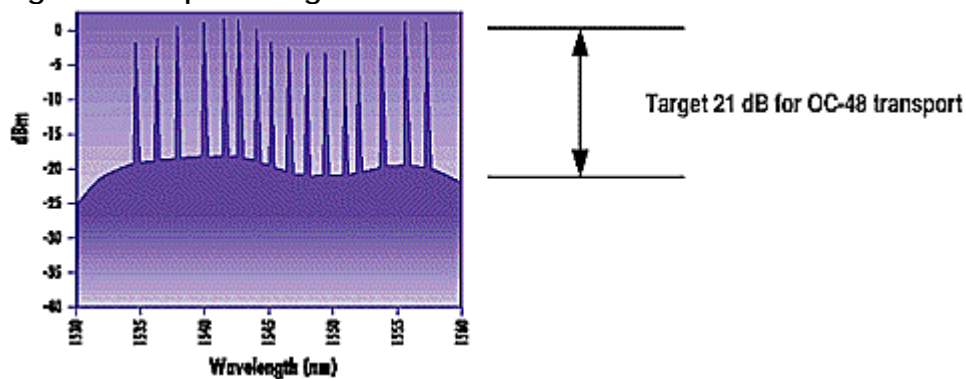
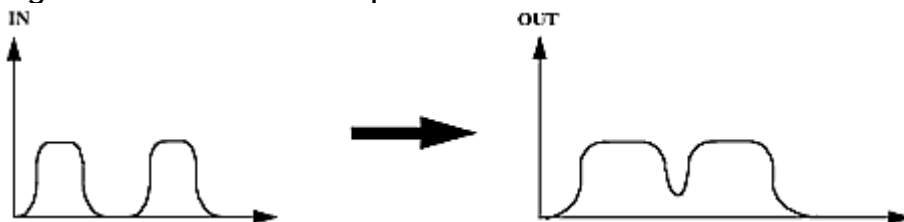

Figure 14. Chromatic Dispersion



Wavelength Routing Plans

The basic element in the optical network is the wavelength. As many wavelengths of signals are transported across the network, it becomes important to manage and switch each one individually. One of the benefits of optical networks is that they allow the network architecture to be different for each wavelength. For example, one wavelength may be established in the network to be part of a ring configuration, while another wavelength, using the same physical network, can be provisioned as a point-to-point system. The flexibility of provisioning the network one wavelength at a time has led to two definitions of end-to-end services: wavelength paths (WPs) and virtual wavelength paths (VWPs).

Wavelength Path

The simplest implementation of a wavelength service in the optical network is a WP. Using a WP, a signal enters and exits the optical layer at the same wavelength, without ever changing to a different wavelength throughout the network. Essentially a wavelength is dedicated to connect the two endpoints.

Virtual Wavelength Path

Although a WP is simple to implement, it can impose some limitations on the bandwidth available in the network and the cost of implementing it. One method by which to overcome this limitation is to use a VWP, in which a signal path can travel on different wavelengths throughout the network. By avoiding a dedicated wavelength for an end-to-end connection, the network can reuse and optimize wavelengths to provide the greatest amount of capacity.

8. Restoration

As optical networks evolve, performing restoration at the optical layer can provide one of the greatest potential cost savings. By implementing a restoration scheme at the optical layer, optical nodes can perform protection for all the wavelengths on a path, with switching times similar to that of current electrical SONET rings (see *Figure 15*). Because protection is performed in the optical layer, the electrical systems do not need the extensive protection architectures that have been required historically, which provides tremendous cost savings to network providers. In addition, optical-layer restoration allows better wavelength utilization by implementing 1:N protection in the SONET/SDH layer.

Figure 15. Optical Reconfiguration Performance

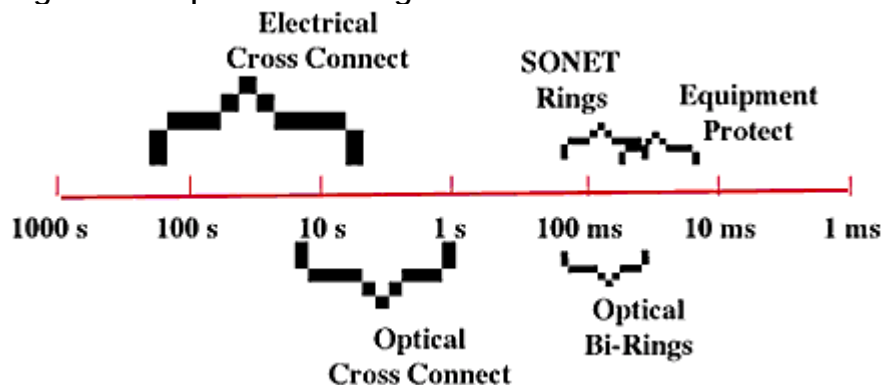

Several methods of protection can be implemented in the optical network, all of which are logically similar to their electrical counterparts.

Link

Link restoration is perhaps the simplest to implement in the optical network. A link restoration routes the optical path across an alternate link between sites, providing protection in case of a fiber or equipment failure. Although providers can dedicate fibers for a protection link, it is usually not cost effective to do so. While a link restoration scheme can provide full restoration for a single link failure, when fibers are shared for working or protection, it provides less than full protection for multiple failures.

Path

Using a 1:N path-restoration scheme allocates a disjointed path for an end-to-end connection, but the alternate path is not dedicated for each connection. So again, although this method provides full restoration for single link failures, it can provide less than full protection for multiple link failures.

Hybrid

A restoration similar to link protection is hybrid restoration. Hybrid restoration provides protection for each link but attempts to improve fiber utilization by eliminating the backhauling of traffic. To accomplish this, the switching near the failed link takes place on nodes that might not be adjacent to the failure.

Ring

Perhaps the most robust protection architecture for optical networks is the optical ring. Optical rings operate identically to their electrical ring equivalents, with the same architectures and alternatives available. Although they require more fiber than other restoration schemes, optical rings provide the highest level of availability. By partitioning wavelengths into groups, network planners can switch certain wavelengths in the optical layer while still performing switching for existing systems in the SONET layer. The partitioning allows a smooth evolution to optical rings.

9. Network Management

One of the most important and difficult issues involved with the optical network is network management for several reasons: restoration, performance, and wavelength services. Although network management of optical networks is a topic too large to cover extensively in an optical network tutorial, some of the important issues are briefly discussed in this module.

First, the optical network is evolving and being implemented on top of an existing SONET architecture, which provides its own restoration and protection schemes. Without a highly intelligent network-management system (NMS), it becomes extremely difficult to ensure that restoration schemes between the electrical and optical layer do not conflict. In addition to mediation between the optical and SONET layer, the network management system must be able to prevent possible conflicts or, at the minimum, enable the service provider to identify conflicts.

In addition to managing the overall network architecture, NMSs must be able to monitor signal performance for each wavelength. With the addition of optical add/drop multiplexers and optical cross-connects, the end-to-end performance of wavelengths becomes more difficult. NMSs for the optical network must assist providers in troubleshooting the network by isolating questionable wavelengths and the possible location of degradation. As the number of wavelengths on each fiber approaches 40 or more, it is important to have an intelligent method to monitor all of them.

Finally, and perhaps most important to the service providers, the ability to manage and provide new services to customers quickly is crucial. As discussed earlier, provisioning end-to-end services can be difficult, especially as network capacity decreases. An intelligent NMS can help providers establish and monitor new end-to-end wavelength services to maximize their bandwidth revenues.

10. Network Evolutions: Part I

As the optical network evolves, network planners must understand a dilemma in best utilizing the optical network. On the one hand, access networks require a transparent optical network that is bit-rate and format independent. This would provide flexibility and allow connection to the network directly with asynchronous transfer mode (ATM), transmission control protocol/Internet protocol (TCP/IP), SONET, or any other signal format without additional equipment costs. It also would allow wavelengths be added and dropped completely optically without affecting the original signal format.

Unfortunately, this transparent model for the access network falls completely apart when applied to metropolitan or long-haul networks. As the distances increase, carriers need to maximize the capacity to reduce costs, and allow any signal data rate onto the network would greatly increase costs. Therein lies the dilemma: networks need the flexibility to provide a variety of end-user services without inefficiencies in the long-haul network. The solution is the optical gateway, which will integrate with existing optical-network elements.

Discussed below are some of the optical-network elements that make end-to-end wavelength services a reality, and how they will be integrated into the network.

Dense Wavelength Division Multiplexing

As discussed earlier, many network providers are already deploying DWDM on a large scale. Fiber-congested, point-to-point segments of long-distance networks were one of the first applications for WDM terminals. Today, 16-channel dense WDM terminals are widely deployed to enhance the bandwidth capacity of the long-haul network backbone. Throughout 1998, the industry will shift to 32 and 40 channel systems, and in following years even more.

Optical Add/Drop Multiplexers (OADM)

The OADM enhances the WDM terminals by adding several significant features (see *Figure 16*). The OADM systems have the capacity of up to 40 optical wavelengths. They efficiently drop and add various wavelengths at intermediate sites along the network—resolving a significant challenge for existing WDM.

Figure 16. Optical ADM Functionality

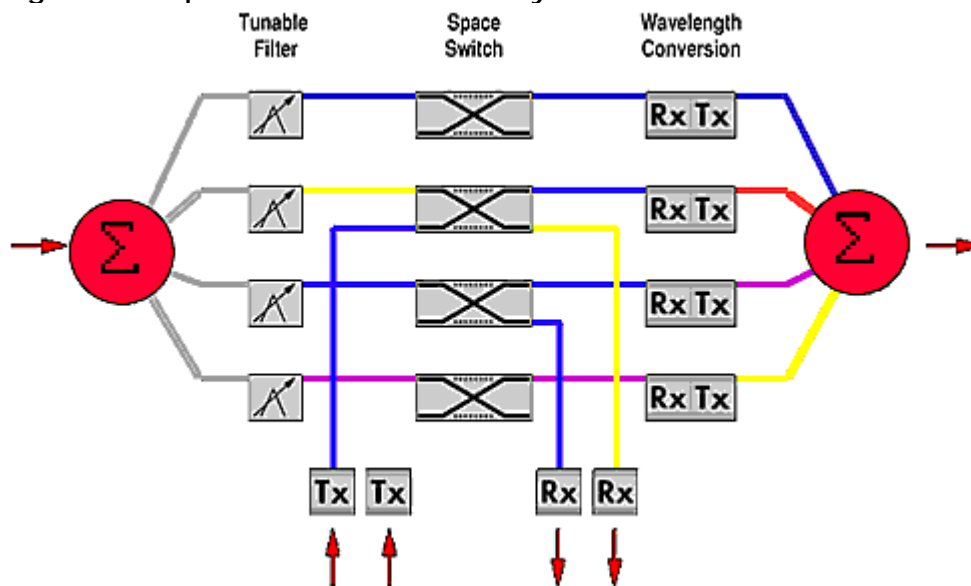

Most important, OADM technology introduces asynchronous transponders to allow the optical-network element to interface directly to high revenue-generating services. It is now possible for ATM, frame relay (FR), native local-area networks (LANs), high-bandwidth Internet protocol (IP), and others to connect directly to the network via a wavelength in the optical layer. Transponder technology also extends the life of older lightwave systems by accepting its bandwidth directly into the optical layer, converting its frequency to an acceptable standard, and providing protection and restoration. The OADM also is the foundation of optical bidirectional line switched rings (OBLSRs), which are described in the next module.

Optical Gateways

In order to access the optical network efficiently and maximize bandwidth capacity and transport-protocol transparency, the optical gateway becomes a critical network element (see *Figure 17*). As a variety of bit rates and signal formats, ranging from asynchronous legacy networks to 10-Gbps SONET systems, a common transport structure must groom and provision traffic entering the optical layer. The emerging basic format for high-speed transparent transport is ATM, and optical gateways will allow a mix of standard SONET and ATM services. By providing a link between the variety of electrical protocols and allowing flexible deployment of any mix of them, optical gateways provide networks the maximum benefits of optical networks.

The optical gateway will be the key element to allow smooth transition to optical networks. As more intelligence is added to the optical layer, costs can be reduced in the SONET layer. For example, as optical rings are implemented, the optical gateway can interface lower cost 1:N protected SONET system with the optical ring. By partitioning wavelengths, existing SONET rings can be kept intact, while new systems are lower-cost integrated 1:N tributaries to the optical layer.

Figure 17. Optical Gateways

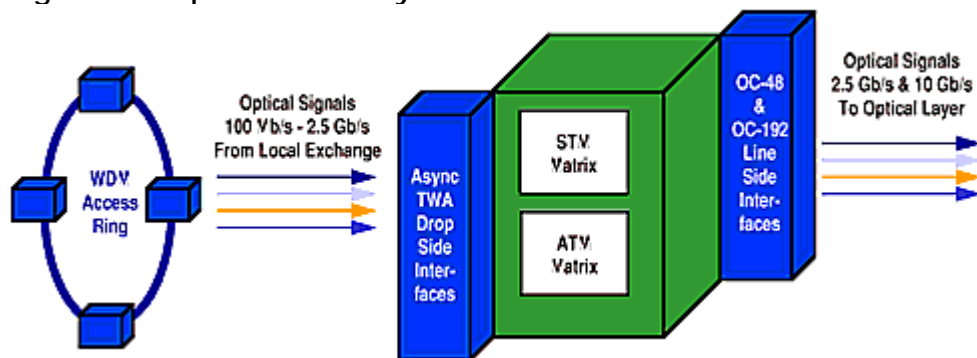

11. Network Evolutions: Part II

Optical Bidirectional Line Switched Rings

Optical-ring architectures utilize reconfigurable OADMs; the ring architecture is a familiar scheme to the telecommunications industry and now applied to the optical domain (see *Figure 18*). The optical ring uses the same principles as the fiber ring to provide protection against equipment and network failures (see *Figure 19*).

Figure 18. Optical Ring Architecture

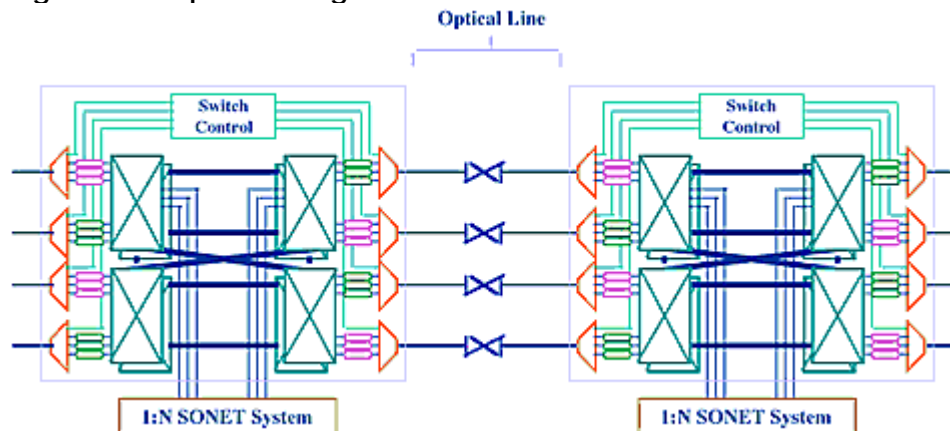
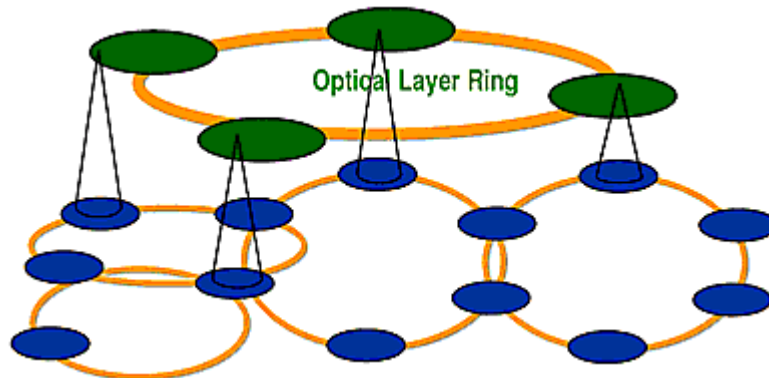

Figure 19. Optical Rings



Network elements have intelligent software that senses a module failure or break in its fiber connection and automatically routes traffic in the opposite direction around the fiber ring. This architecture allows service providers to guarantee that customers' connection will not go out of service. However, the network elements now support multiple optical wavelengths as opposed to multiple DS-3 circuits. In the case of a fiber break, the optical network will automatically reroute up to 40 optical signals in less than 50 milliseconds.

Because optical rings are most cost effective over large networks, the switching time is critical. One technology planned for implementation is called network protection equipment (NPE), which significantly reduces the switching time required in large optical networks. Instead of routing traffic from network elements adjacent to a fiber cut, the OBLSR using NPE redirects the traffic from the node where it enters the ring. This redirection prevents the traffic from being backhauled across the network, which greatly improves overall switching time.

Optical Cross-Connect (OXC)

Efficient use of fiber facilities at the optical level obviously becomes critical as service providers begin to move wavelengths around the world. Routing and grooming are key areas that must be addressed. This is the function of the OXC, as shown in *Figure 20*.

Figure 20. OXC Block Diagram

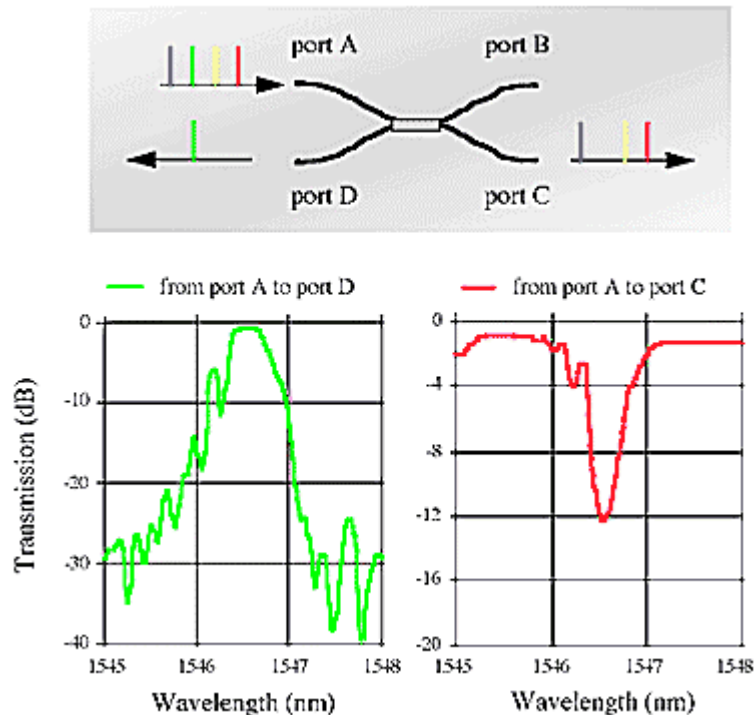

Digital cross-connect systems are deployed en masse and provide the critical function of grooming traffic (DS-0, DS-1, and DS-3) to fill output ports on the system efficiently. Today, output ports can be at the DS-3, OC-3, or OC-12 level. For this reason, it is critical to ensure that those pipes are full of traffic when they exit the cross-connect system. In the optical domain, where 40 optical channels can be transported on a single fiber, a network element is needed that can accept various wavelengths on input ports and route them to appropriate output ports in the network. To accomplish this, the OXC needs three building blocks (see *Figure 21*):

- **fiber switching**—the ability to route all of the wavelengths on an incoming fiber to a different outgoing fiber
- **wavelength switching**—the ability to switch specific wavelengths from an incoming fiber to multiple outgoing fibers

- **wavelength conversion**—The ability to take incoming wavelengths and convert them (on the fly) to another optical frequency on the outgoing port; this is necessary to achieve strictly nonblocking architectures when using wavelength switching

Figure 21. Optical Cross-Connects

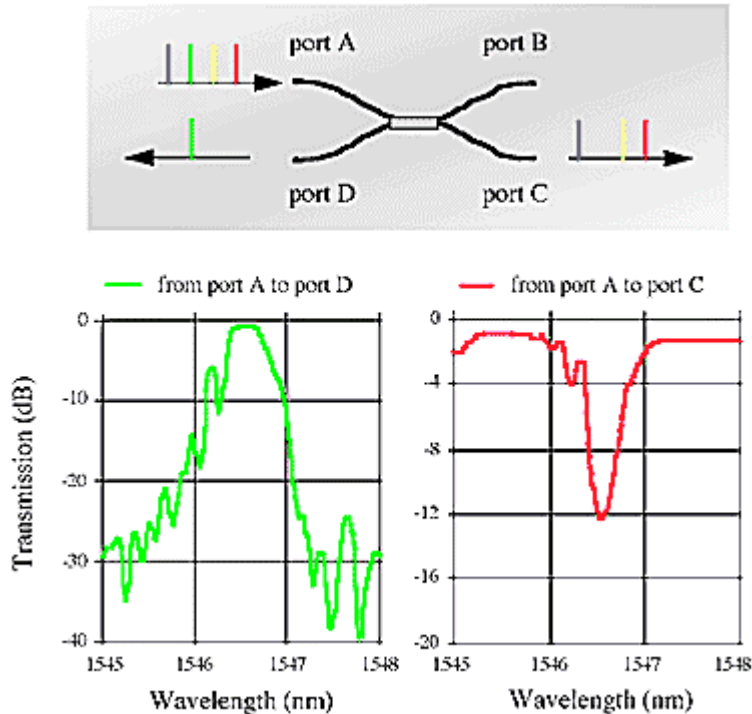

12. The Future of Optical Networks

Continued advancements in optical technology promise continued change as the optical network evolves to the ultimate goal of end-to-end wavelength services.

The impact of the new optical layer in the telecommunications network is astounding. It can be measured in two ways—economic impact and carriers' ability to offer new services. Optical-layer technology will increase network capacity, allowing network providers to transport more than 40 times the traffic on the same fiber infrastructure. That will ultimately lead to lower prices, and competition in the local exchange (as a result of the Telecommunications Reform Act of 1996) will ensure that bandwidth becomes more affordable.

Consumers will have access to new high-bandwidth services made possible by the increased capacity afforded by the optical layer. Services that today are considered prohibitively expensive, such as videoconferencing to the desktop (or home), electronic commerce, and high-speed video imaging, will become commonplace because they will be technologically and economically feasible.

In essence, optical-layer technology will improve the way we live.

Self-Test

1. Optical networks are based on the emergence of the _____ layer in _____ networks.
 - a. optical; transport
 - b. transport; optical
 - c. optical; integrated
 - d. optical; high-capacity

2. In the _____ a revolution in the technology for telecommunications networks began, spawned by the use of a relatively unassuming technology, _____.
 - a. early 1990s; fiber-optic cable
 - b. early 1980s; synchronous cable
 - c. early 1980s; fiber-optic cable
 - d. early 1990s; asynchronous cable

3. The one aspect of SONET that has allowed it to survive during a time of tremendous changes in network capacity needs is its _____.
 - a. versatility
 - b. scalability
 - c. fiber capacity
 - d. functionality

4. One of the great revenue-producing aspects of optical networks is the ability to resell _____ rather than _____.
 - a. bandwidth; fiber
 - b. fiber; bandwidth
 - c. wavelength; bandwidth

- d. single fiber; double fiber
5. The first incarnation of WDM was _____.
- a. broadband WDM
 - b. the erbium-doped optical amplifier
 - c. dense WDM
 - d. narrowband lasers
6. A fiber Bragg grating is a small section of fiber that has been modified to create periodic changes in the index of refraction.
- a. true
 - b. false
7. One of the most promising technologies for optical networks is the SOA.
- a. true
 - b. false
8. A wavelength converter provides functionality similar to an electrical switch by routing an incoming wavelength to a variety of physical output ports.
- a. true
 - b. false
9. One of the benefits of a long-haul network is its conservative use of bandwidth.
- a. true
 - b. false
10. The basic element in the optical network is the wavelength.
- a. true
 - b. false

Correct Answers

1. Optical networks are based on the emergence of the _____ layer in _____ networks.

a. optical; transport

b. transport; optical

c. optical; integrated

d. optical; high-capacity

See Topic Overview.

2. In the _____ a revolution in the technology for telecommunications networks began, spawned by the use of a relatively unassuming technology, _____.

a. early 1990s; fiber-optic cable

b. early 1980s; synchronous cable

c. early 1980s; fiber-optic cable

d. early 1990s; asynchronous cable

See Topic 1.

3. The one aspect of SONET that has allowed it to survive during a time of tremendous changes in network capacity needs is its _____.

a. versatility

b. scalability

c. fiber capacity

d. functionality

See Topic 1.

4. One of the great revenue-producing aspects of optical networks is the ability to resell _____ rather than _____.

a. bandwidth; fiber

b. fiber; bandwidth

- c. wavelength; bandwidth
- d. single fiber; double fiber

See Topic 2.

5. The first incarnation of WDM was _____.

a. broadband WDM

- b. the erbium-doped optical amplifier
- c. dense WDM
- d. narrowband lasers

See Topic 2.

6. A fiber Bragg grating is a small section of fiber that has been modified to create periodic changes in the index of refraction.

a. true

b. false

See Topic 3.

7. One of the most promising technologies for optical networks is the SOA.

a. true

b. false

See Topic 4.

8. A wavelength converter provides functionality similar to an electrical switch by routing an incoming wavelength to a variety of physical output ports.

a. true

b. false

See Topic 5.

9. One of the benefits of a long-haul network is its conservative use of bandwidth.

a. true

b. false

See Topic 6.

10. The basic element in the optical network is the wavelength.

a. true

b. false

See Topic 7.

Glossary

ATM

asynchronous transfer mode

DWDM

dense wavelength division multiplexing

ETDM

electronic time division multiplexing

IOF

interoffice networks

LAN

local-area network

MAN

metropolitan-area network

OADM

optical add/drop multiplexer

OBLSR

optical bidirectional line switched rings

OSNR

optical signal-to-noise ratio

OTDM

optical time division multiplexing

OXC

optical cross-connect

PBST

phase-shaped binary transmission

SOA

semiconductor optical amplifier

SONET

synchronous optical network

TCP/IP

transmission control protocol/Internet protocol

TDM

time division multiplexing

VWP

virtual wavelength path

WAN

wide-area network

WDM

wavelength division multiplexing

WP

wavelength path