



# Multiprotocol Label Switching (MPLS)

## Definition

Multiprotocol label switching (MPLS) is a versatile solution to address the problems faced by present-day networks—speed, scalability, quality-of-service (QoS) management, and traffic engineering. MPLS has emerged as an elegant solution to meet the bandwidth-management and service requirements for next-generation Internet protocol (IP)–based backbone networks. MPLS addresses issues related to scalability and routing (based on QoS and service quality metrics) and can exist over existing asynchronous transfer mode (ATM) and frame-relay networks.

## Overview

This tutorial provides an in-depth look at the technology behind MPLS, with an emphasis on the protocols involved. The tutorial also discusses why MPLS is an important component in the deployment of converged networks.

## Topics

1. Introduction
  2. Traditional Routing and Packet Switching
  3. MPLS and Its Components
  4. MPLS Operation
  5. MPLS Protocol Stack Architecture
  6. MPLS Applications
  7. Standards Groups
- Self-Test
- Correct Answers
- Glossary

## 1. Introduction

Over the last few years, the Internet has evolved into a ubiquitous network and inspired the development of a variety of new applications in business and

consumer markets. These new applications have driven the demand for increased and guaranteed bandwidth requirements in the backbone of the network. In addition to the traditional data services currently provided over the Internet, new voice and multimedia services are being developed and deployed. The Internet has emerged as the network of choice for providing these converged services. However, the demands placed on the network by these new applications and services, in terms of speed and bandwidth, have strained the resources of the existing Internet infrastructure. This transformation of the network toward a packet- and cell-based infrastructure has introduced uncertainty into what has traditionally been a fairly deterministic network.

In addition to the issue of resource constraints, another challenge relates to the transport of bits and bytes over the backbone to provide differentiated classes of service to users. The exponential growth in the number of users and the volume of traffic adds another dimension to this problem. Class of service (CoS) and QoS issues must be addressed in order to support the diverse requirements of the wide range of network users.

In sum, despite some initial challenges, MPLS will play an important role in the routing, switching, and forwarding of packets through the next-generation network in order to meet the service demands of the network users.

## 2. Traditional Routing and Packet Switching

The initial deployment of the Internet addressed the requirements of data transfer over the network. This network catered to simple applications such as file transfer and remote login. To carry out these requirements, a simple software-based router platform, with network interfaces to support the existing T1/E1- or T3/E3-based backbones, was sufficient. As the demand for higher speed and the ability to support higher-bandwidth transmission rates emerged, devices with capabilities to switch at the Level-2 (data link) and the Level-3 (network layer) in hardware had to be deployed. Layer-2 switching devices addressed the switching bottlenecks within the subnets of a local-area network (LAN) environment. Layer-3 switching devices helped alleviate the bottleneck in Layer-3 routing by moving the route lookup for Layer-3 forwarding to high-speed switching hardware.

These early solutions addressed the need for wire-speed transfer of packets as they traversed the network, but they did not address the service requirements of the information contained in the packets. Also, most of the routing protocols deployed today are based on algorithms designed to obtain the shortest path in the network for packet traversal and do not take into account additional metrics (such as delay, jitter, and traffic congestion), which can further diminish network performance. Traffic engineering is a challenge for network managers.

## 3. MPLS and Its Components

### What Is MPLS?

MPLS is an Internet Engineering Task Force (IETF)–specified framework that provides for the efficient designation, routing, forwarding, and switching of traffic flows through the network.

MPLS performs the following functions:

- specifies mechanisms to manage traffic flows of various granularities, such as flows between different hardware, machines, or even flows between different applications
- remains independent of the Layer-2 and Layer-3 protocols
- provides a means to map IP addresses to simple, fixed-length labels used by different packet-forwarding and packet-switching technologies
- interfaces to existing routing protocols such as resource reservation protocol (RSVP) and open shortest path first (OSPF)
- supports the IP, ATM, and frame-relay Layer-2 protocols

In MPLS, data transmission occurs on label-switched paths (LSPs). LSPs are a sequence of labels at each and every node along the path from the source to the destination. LSPs are established either prior to data transmission (control-driven) or upon detection of a certain flow of data (data-driven). The labels, which are underlying protocol-specific identifiers, are distributed using label distribution protocol (LDP) or RSVP or piggybacked on routing protocols like border gateway protocol (BGP) and OSPF. Each data packet encapsulates and carries the labels during their journey from source to destination. High-speed switching of data is possible because the fixed-length labels are inserted at the very beginning of the packet or cell and can be used by hardware to switch packets quickly between links.

### LSRs and LERs

The devices that participate in the MPLS protocol mechanisms can be classified into label edge routers (LERs) and label switching routers (LSRs).

An LSR is a high-speed router device in the core of an MPLS network that participates in the establishment of LSPs using the appropriate label signaling

protocol and high-speed switching of the data traffic based on the established paths.

An LER is a device that operates at the edge of the access network and MPLS network. LERs support multiple ports connected to dissimilar networks (such as frame relay, ATM, and Ethernet) and forwards this traffic on to the MPLS network after establishing LSPs, using the label signaling protocol at the ingress and distributing the traffic back to the access networks at the egress. The LER plays a very important role in the assignment and removal of labels, as traffic enters or exits an MPLS network.

## FEC

The forward equivalence class (FEC) is a representation of a group of packets that share the same requirements for their transport. All packets in such a group are provided the same treatment en route to the destination. As opposed to conventional IP forwarding, in MPLS, the assignment of a particular packet to a particular FEC is done just once, as the packet enters the network. FECs are based on service requirements for a given set of packets or simply for an address prefix. Each LSR builds a table to specify how a packet must be forwarded. This table, called a label information base (LIB), is comprised of FEC-to-label bindings.

## Labels and Label Bindings

A label, in its simplest form, identifies the path a packet should traverse. A label is carried or encapsulated in a Layer-2 header along with the packet. The receiving router examines the packet for its label content to determine the next hop. Once a packet has been labeled, the rest of the journey of the packet through the backbone is based on label switching. The label values are of local significance only, meaning that they pertain only to hops between LSRs.

Once a packet has been classified as a new or existing FEC, a label is assigned to the packet. The label values are derived from the underlying data link layer. For data link layers (such as frame relay or ATM), Layer-2 identifiers, such as data link connection identifiers (DLCIs) in the case of frame-relay networks or virtual path identifiers (VPIs)/virtual channel identifiers (VCIs) in case of ATM networks, can be used directly as labels. The packets are then forwarded based on their label value.

Labels are bound to an FEC as a result of some event or policy that indicates a need for such binding. These events can be either data-driven bindings or control-driven bindings. The latter is preferable because of its advanced scaling properties that can be used in MPLS.

Label assignment decisions may be based on forwarding criteria such as the following:

- destination unicast routing
- traffic engineering
- multicast
- virtual private network (VPN)
- QoS

The generic label format is illustrated in *Figure 1*. The label can be embedded in the header of the data link layer (the ATM VCI/VPI shown in *Figure 2* and the frame-relay DLCI shown in *Figure 3*) or in the shim (between the Layer-2 data-link header and Layer-3 network layer header, as shown in *Figure 4*).

Figure 1. MPLS Generic Label Format

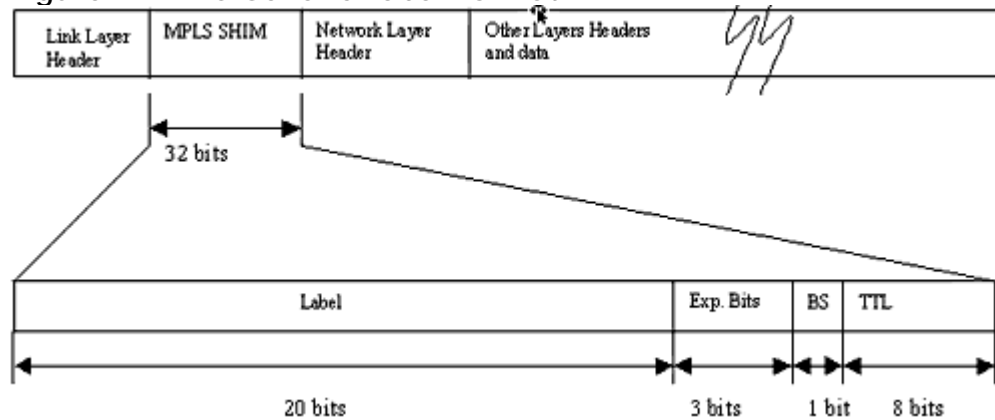

Figure 2. ATM as the Data Link Layer

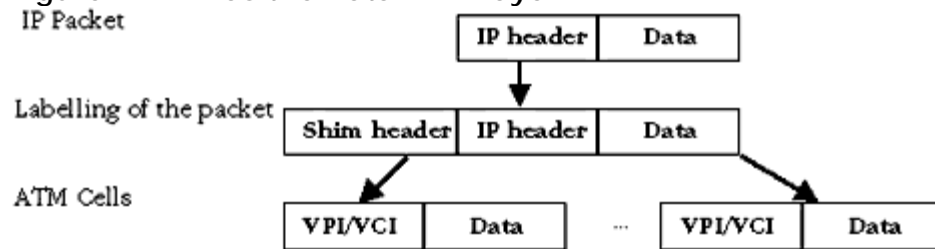
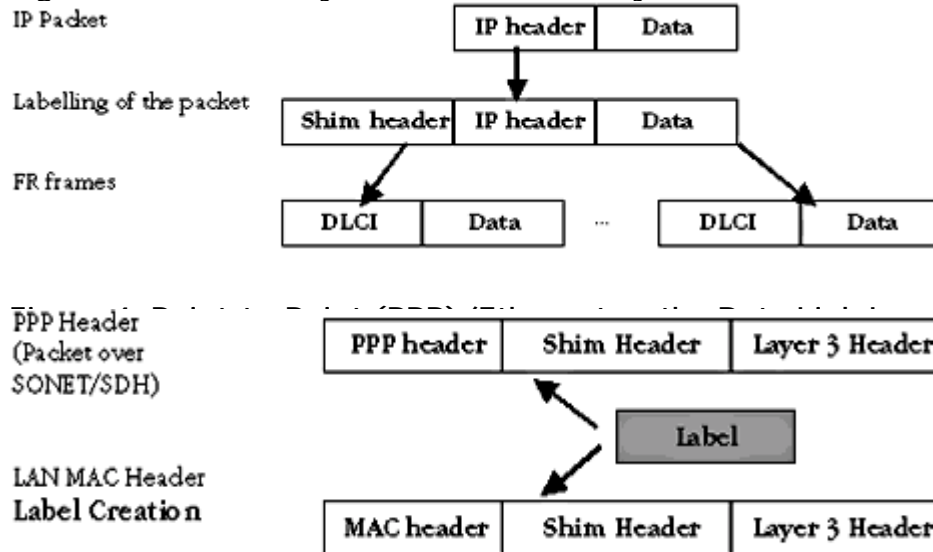

Figure 3. Frame Relay as the Data Link Layer



## Label Creation

There are several methods used in label creation:

- **topology-based method**—uses normal processing of routing protocols (such as OSPF and BGP)
- **request-based method**—uses processing of request-based control traffic (such as RSVP)
- **traffic-based method**—uses the reception of a packet to trigger the assignment and distribution of a label

The topology- and request-based methods are examples of control-driven label bindings, while the traffic-based method is an example of data-driven bindings.

## Label Distribution

MPLS architecture does not mandate a single method of signaling for label distribution. Existing routing protocols, such as the border gateway protocol (BGP), have been enhanced to piggyback the label information within the contents of the protocol. The RSVP has also been extended to support piggybacked exchange of labels. The Internet Engineering Task Force (IETF) has also defined a new protocol known as the label distribution protocol (LDP) for explicit signaling and management of the label space. Extensions to the base LDP protocol have also been defined to support explicit routing based on QoS and CoS

requirements. These extensions are captured in the constraint-based routing (CR)–LDP protocol definition.

A summary of the various schemes for label exchange is as follows:

- **LDP**—maps unicast IP destinations into labels
- **RSVP, CR–LDP**—used for traffic engineering and resource reservation
- **protocol-independent multicast (PIM)**—used for multicast states label mapping
- **BGP**—external labels (VPN)

## Label-Switched Paths (LSPs)

A collection of MPLS–enabled devices represents an MPLS domain. Within an MPLS domain, a path is set up for a given packet to travel based on an FEC. The LSP is set up prior to data transmission. MPLS provides the following two options to set up an LSP.

- **hop-by-hop routing**—Each LSR independently selects the next hop for a given FEC. This methodology is similar to that currently used in IP networks. The LSR uses any available routing protocols, such as OSPF, ATM private network-to-network interface (PNNI), etc.
- **explicit routing**—Explicit routing is similar to source routing. The ingress LSR (i.e., the LSR where the data flow to the network first starts) specifies the list of nodes through which the ER–LSP traverses. The path specified could be nonoptimal, as well. Along the path, the resources may be reserved to ensure QoS to the data traffic. This eases traffic engineering throughout the network, and differentiated services can be provided using flows based on policies or network management methods.

The LSP setup for an FEC is unidirectional in nature. The return traffic must take another LSP.

## Label Spaces

The labels used by an LSR for FEC–label bindings are categorized as follows:

- **per platform**—The label values are unique across the whole LSR. The labels are allocated from a common pool. No two labels distributed on different interfaces have the same value.
- **per interface**—The label ranges are associated with interfaces. Multiple label pools are defined for interfaces, and the labels provided on those interfaces are allocated from the separate pools. The label values provided on different interfaces could be the same.

## Label Merging

The incoming streams of traffic from different interfaces can be merged together and switched using a common label if they are traversing the network toward the same final destination. This is known as stream merging or aggregation of flows.

If the underlying transport network is an ATM network, LSRs could employ virtual path (VP) or virtual channel (VC) merging. In this scenario, cell interleaving problems, which arise when multiple streams of traffic are merged in the ATM network, need to be avoided.

## Label Retention

MPLS defines the treatment for label bindings received from LSRs that are not the next hop for a given FEC. Two modes are defined.

- **conservative**—In this mode, the bindings between a label and an FEC received from LSRs that are not the next hop for a given FEC are discarded. This mode requires an LSR to maintain fewer labels. This is the recommended mode for ATM-LSRs.
- **liberal**—In this mode, the bindings between a label and an FEC received from LSRs that are not the next hop for a given FEC are retained. This mode allows for quicker adaptation to topology changes and allows for the switching of traffic to other LSPs in case of changes.

## Label Control

MPLS defines modes for distribution of labels to neighboring LSRs.

- **independent**—In this mode, an LSR recognizes a particular FEC and makes the decision to bind a label to the FEC independently to distribute the binding to its peers. The new FECs are recognized whenever new routes become visible to the router.



- **ordered**—In this mode, an LSR binds a label to a particular FEC if and only if it is the egress router or it has received a label binding for the FEC from its next hop LSR. This mode is recommended for ATM–LSRs.

## Signaling Mechanisms

- **label request**—Using this mechanism, an LSR requests a label from its downstream neighbor so that it can bind to a specific FEC. This mechanism can be employed down the chain of LSRs up until the egress LER (i.e., the point at which the packet exits the MPLS domain).
- **label mapping**—In response to a label request, a downstream LSR will send a label to the upstream initiator using the label mapping mechanism.

The above concepts for label request and label mapping are explained in *Figure 5*.

Figure 5. Signaling Mechanisms

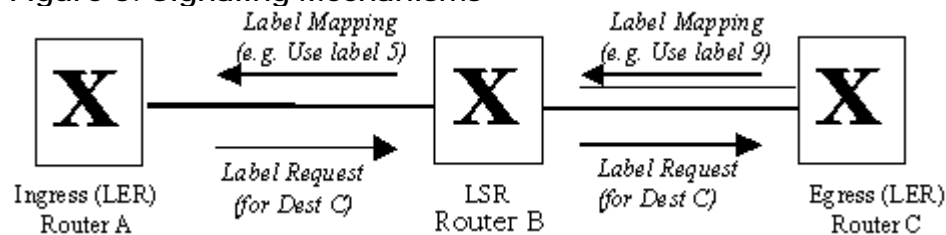

## Label Distribution Protocol (LDP)

The LDP is a new protocol for the distribution of label binding information to LSRs in an MPLS network. It is used to map FECs to labels, which, in turn, create LSPs. LDP sessions are established between LDP peers in the MPLS network (not necessarily adjacent). The peers exchange the following types of LDP messages:

- **discovery messages**—announce and maintain the presence of an LSR in a network
- **session messages**—establish, maintain, and terminate sessions between LDP peers
- **advertisement messages**—create, change, and delete label mappings for FECs

- **notification messages**—provide advisory information and signal error information

## Label Stack

The label stack mechanism allows for hierarchical operation in the MPLS domain. It basically allows MPLS to be used simultaneously for routing at the fine-grain level (e.g., between individual routers within an Internet service provider [ISP] and at a higher domain-by-domain level). Each level in a label stack pertains to some hierarchical level. This facilitates a tunneling mode of operation in MPLS.

## Traffic Engineering

Traffic engineering is a process that enhances overall network utilization by attempting to create a uniform or differentiated distribution of traffic throughout the network. An important result of this process is the avoidance of congestion on any one path. It is important to note that traffic engineering does not necessarily select the shortest path between two devices. It is possible that, for two packet data flows, the packets may traverse completely different paths even though their originating node and the final destination node are the same. This way, the less-exposed or less-used network segments can be used and differentiated services can be provided.

In MPLS, traffic engineering is inherently provided using explicitly routed paths. The LSPs are created independently, specifying different paths that are based on user-defined policies. However, this may require extensive operator intervention. RSVP and CR–LDP are two possible approaches to supply dynamic traffic engineering and QoS in MPLS.

## CR

Constraint-based routing (CR) takes into account parameters, such as link characteristics (bandwidth, delay, etc.), hop count, and QoS. The LSPs that are established could be CR–LSPs, where the constraints could be explicit hops or QoS requirements. Explicit hops dictate which path is to be taken. QoS requirements dictate which links and queuing or scheduling mechanisms are to be employed for the flow.

When using CR, it is entirely possible that a longer (in terms of cost) but less loaded path is selected. However, while CR increases network utilization, it adds more complexity to routing calculations, as the path selected must satisfy the QoS requirements of the LSP. CR can be used in conjunction with MPLS to set up

LSPs. The IETF has defined a CR–LDP component to facilitate constraint-based routes.

## 4. MPLS Operation

The following steps must be taken for a data packet to travel through an MPLS domain.

1. label creation and distribution
2. table creation at each router
3. label-switched path creation
4. label insertion/table lookup
5. packet forwarding

The source sends its data to the destination. In an MPLS domain, not all of the source traffic is necessarily transported through the same path. Depending on the traffic characteristics, different LSPs could be created for packets with different CoS requirements.

In *Figure 6*, LER1 is the ingress and LER4 is the egress router.

**Figure 6. LSP Creation and Packet Forwarding through an MPLS Domain**

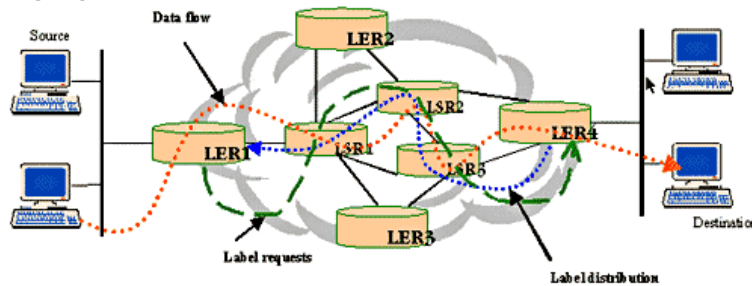

*Table 1* illustrates the step-by-step MPLS operations that occur on the data packets in an MPLS domain.

**Table 1. MPLS Actions**

MPLS Actions	Description
label creation and label distribution	<p>Before any traffic begins the routers make the decision to bind a label to a specific FEC and build their tables.</p> <p>In LDP, downstream routers initiate the distribution of labels and the label/FEC binding.</p> <p>In addition, traffic-related characteristics and MPLS capabilities are</p>

	<p>negotiated using LDP.</p> <p>A reliable and ordered transport protocol should be used for the signaling protocol. LDP uses TCP.</p>
table creation	<p>On receipt of label bindings each LSR creates entries in the label information base (LIB).</p> <p>The contents of the table will specify the mapping between a label and an FEC.</p> <p>mapping between the input port and input label table to the output port and output label table.</p> <p>The entries are updated whenever renegotiation of the label bindings occurs.</p>
label switched path creation	<p>As shown by the dashed blue lines in <i>Figure 6</i>, the LSPs are created in the reverse direction to the creation of entries in the LIBs.</p>
label insertion/table-lookup	<p>The first router (LER1 in <i>Figure 6</i>) uses the LIB table to find the next hop and request a label for the specific FEC.</p> <p>Subsequent routers just use the label to find the next hop.</p> <p>Once the packet reaches the egress LSR (LER4), the label is removed and the packet is supplied to the destination.</p>
packet forwarding	<p>With reference to <i>Figure 6</i> let us examine the path of a packet as it to its destination from LER1, the ingress LSR, to LER4, the egress LSR.</p> <p>LER1 may not have any labels for this packet as it is the first occurrence of this request. In an IP network, it will find the longest address match to find the next hop. Let LSR1 be the next hop for LER1.</p> <p>LER1 will initiate a label request toward LSR1.</p> <p>This request will propagate through the network as indicated by the broken green lines.</p> <p>Each intermediary router will receive a label from its downstream router starting from LER2 and going upstream till LER1. The LSP setup is indicated by the broken blue lines using LDP or any other signaling protocol. If traffic engineering is required, CR-LDP will be used in determining the actual path setup to ensure the QoS/CoS requirements are complied with.</p> <p>LER1 will insert the label and forward the packet to LSR1.</p> <p>Each subsequent LSR, i.e., LSR2 and LSR3, will examine the label in the received packet, replace it with the outgoing label and forward it.</p> <p>When the packet reaches LER4, it will remove the label because the packet is departing from an MPLS domain and deliver it to the destination.</p> <p>The actual data path followed by the packet is indicated by the broken red lines.</p>

Table 2 shows a simple example of the LIB tables.

Table 2. Example LIB Table

Input Port	Incoming Port Label	Output Port	Outgoing Port Label
1	3	3	6
2	9	1	7

It is interesting to consider the example of two streams of data packets entering an MPLS domain:

- One packet stream is a regular data exchange between servers (e.g., file transfer protocol [FTP]).
- The other packet stream is an intensive video stream, which requires the traffic engineering parameters of QoS (e.g., videoconferencing).
- These packet streams are classified into 2 separate FECs at the ingress LSR.
- The label mappings associated with the streams are 3 and 9, respectively.
- The input ports at the LSR are 1 and 2, respectively.
- The corresponding output interfaces are 3 and 1, respectively.
- Label swapping must also be done, and the previous labels must be exchanged for 6 and 7, respectively.

## Tunneling in MPLS

A unique feature of MPLS is that it can control the entire path of a packet without explicitly specifying the intermediate routers. It does this by creating tunnels through the intermediary routers that can span multiple segments. This concept is used in provisioning MPLS-based VPNs.

Consider the scenario in *Figure 7*. LERs (LER1, LER2, LER3, and LER4) all use BGP and create an LSP between them (LSP 1). LER1 is aware that its next destination is LER2, as it is transporting data for the source, which must go through two segments of the network. In turn, LER2 is aware that LER3 is its next destination, and so on. These LERs will use the LDP to receive and store labels from the egress LER (LER4 in this scenario) all the way to the ingress LER (LER1).

Figure 7. Tunneling in MPLS

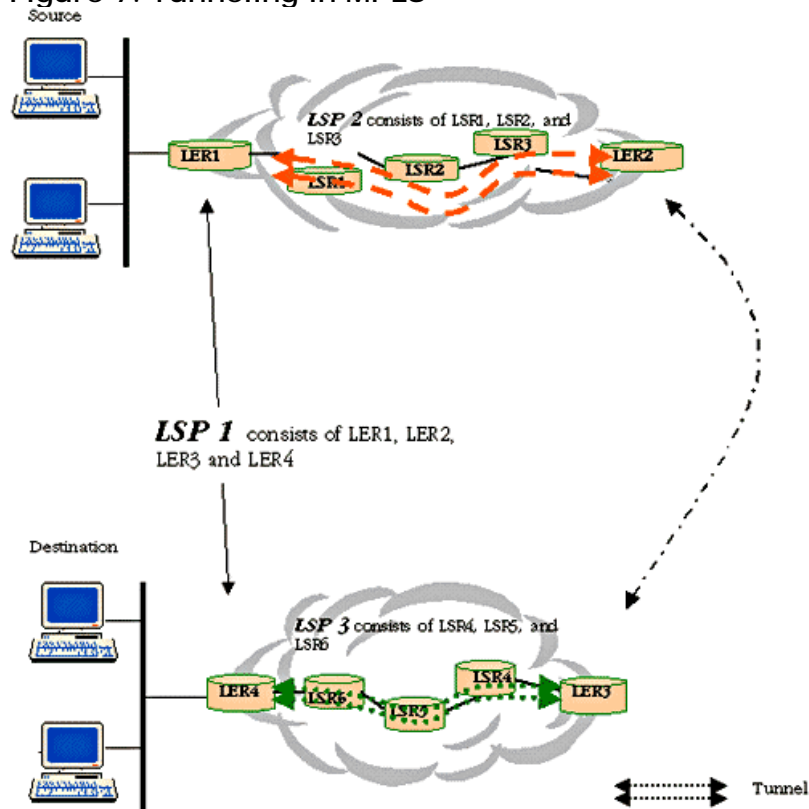

However, for LER1 to send its data to LER2, it must go through several (in this case three) LSRs. Therefore, a separate LSP (LSP 2) is created between the two LERs (LER1 and LER2) that spans LSR1, LSR2, and LSR3. This, in effect, represents a tunnel between the two LERs. The labels in this path are different from the labels that the LERs created for LSP1. This holds true for LER3 and LER4, as well as for the LSRs in between them. LSP 3 is created for this segment.

To achieve this, the concept of a label stack is used when transporting the packet through two network segments. As a packet must travel through LSP 1, LSP 2, and LSP 3, it will carry two complete labels at a time. The pair used for each segment is (1) first segment, label for LSP 1 and LSP 2 and (2) second segment, label for LSP 1 and LSP 3.

When the packet exits the first network and is received by LER3, it will remove the label for LSP 2 and replace it with LSP 3 label, while swapping LSP 1 label within the packet with the next hop label. LER4 will remove both labels before sending the packet to the destination.

# Multicast Operation

The multicast operation of MPLS is currently not defined. However, a general approach has been recommended whereby an incoming label is mapped to a set of outgoing labels. This can be constructed via a multicast tree. In this case, the incoming label will bind to the multicast tree and a set of output ports is used to transmit the packet. This operation is quite conducive to a local-area-network (LAN) environment. In a connection-oriented network such as ATM, the point-to-multipoint switched paths (VCCs) can be used for distributing multicast traffic.

## 5. MPLS Protocol Stack Architecture

The core MPLS components can be broken down into the following parts:

- network layer (IP) routing protocols
- edge of network layer forwarding
- core network label-based switching
- label schematics and granularity
- signaling protocol for label distribution
- traffic engineering
- compatibility with various Layer-2 forwarding paradigms (ATM, frame relay, PPP)

*Figure 8* depicts the protocols that can be used for MPLS operations. The routing module can be any one of several popular industry protocols. Depending on the operating environment, the routing module can be OSPF, BGP, or ATM's PNNI, etc. The LDP module utilizes transmission control protocol (TCP) for reliable transmission of control data from one LSR to another during a session. The LDP also maintains the LIB. The LDP uses the user datagram protocol (UDP) during its discovery phase of operation. In this phase, the LSR tries to identify neighboring elements and also signals its own presence to the network. This is done through an exchange of hello packets.

Figure 8. MPLS Protocol Stack

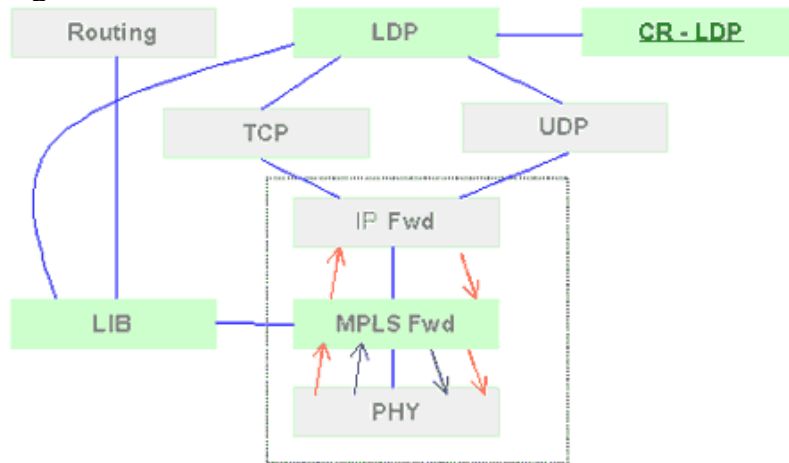

The IP Fwd is the classic IP-forwarding module that looks up the next hop by matching the longest address in its tables. For MPLS, this is done by LERs only. The MPLS Fwd is the MPLS forwarding module that matches a label to an outgoing port for a given packet. The layers, shown in the box with the broken line, can be implemented in hardware for fast, efficient operation.

## 6. MPLS Applications

MPLS addresses today's network backbone requirements effectively by providing a standards-based solution that accomplishes the following:

- improves packet-forwarding performance in the network
  - MPLS enhances and simplifies packet forwarding through routers using Layer-2 switching paradigms.
  - MPLS is simple, which allows for easy implementation.
  - MPLS increases network performance because it enables routing by switching at wireline speeds.
- supports QoS and CoS for service differentiation
  - MPLS uses traffic-engineered path setup and helps achieve service-level guarantees.
  - MPLS incorporates provisions for constraint-based and explicit path setup.
- supports network scalability



- MPLS can be used to avoid the  $N^2$  overlay problem associated with meshed IP–ATM networks.
- integrates IP and ATM in the network
  - MPLS provides a bridge between access IP and core ATM.
  - MPLS can reuse existing router/ATM switch hardware, effectively joining the two disparate networks.
- builds interoperable networks
  - MPLS is a standards-based solution that achieves synergy between IP and ATM networks.
  - MPLS facilitates IP–over-synchronous optical network (SONET) integration in optical switching.
  - MPLS helps build scalable VPNs with traffic-engineering capability.

## 7. Standard Groups

### IETF

The following are the MPLS working groups in the IETF:

- Routing Area Working Group
- MPLS Working Group

### ATM Forum

The following are the MPLS working groups in the ATM Forum:

- Traffic Management Working Group
- ATM–IP Collaboration Working Group

### Self-Test

1. MPLS is independent of the Layer-2 and Layer-3 protocols being used.
  - a. true

- b. false
2. Labels can be created based on the \_\_\_\_\_.
    - a. topology-based method
    - b. request-based method
    - c. traffic-based method
    - d. all of the above
  3. CR–LDP is used for label distribution based on traffic-engineering requirements.
    - a. true
    - b. false
  4. Label-switched path creation is done only by hop-by-hop routing.
    - a. true
    - b. false
  5. Label merging is used for \_\_\_\_\_.
    - a. merging traffic on different interfaces headed for different destinations
    - b. merging traffic on different interfaces headed for the same destination
    - c. a and b
  6. MPLS uses the following signaling mechanism \_\_\_\_\_.
    - a. label request and label mapping message
    - b. discovery and session message
    - c. advertisement and notification message
    - d. all of the above
  7. In LDP, downstream routers initiate the distribution of labels and label/FEC bindings.
    - a. true
    - b. false

8. Label swapping occurs only at the edges of the network—i.e., at the LERs only.
- a. true
  - b. false
9. MPLS supports creation of tunnels so that it can control the entire path of a packet \_\_\_\_\_.
- a. without explicitly specifying the intermediate routers but only on the same network segment
  - b. without explicitly specifying the intermediate routers that can span multiple network segments
  - c. but it needs to explicitly specify the intermediate routers and is limited to the same network segment
  - d. but it needs to explicitly specify the intermediate routers that can span multiple network segments
10. The following routing protocol can be used for initial route setup \_\_\_\_\_.
- a. OSPF
  - b. BGP
  - c. ATM PNNI
  - d. all of the above
11. LDP uses \_\_\_\_\_ for reliable transmission of control data between LSR.
- a. TCP
  - b. UDP
  - c. both
12. MPLS applications include \_\_\_\_\_.
- a. network scalability
  - b. traffic engineering
  - c. improving network interoperability and efficiency

d. all of the above

## Correct Answers

1. MPLS is independent of the Layer-2 and Layer-3 protocols being used.

**a. true**

b. false

See Topic 3.

2. Labels can be created based on the \_\_\_\_\_.

a. topology-based method

b. request-based method

c. traffic-based method

**d. all of the above**

See Topic 3.

3. CR-LDP is used for label distribution based on traffic-engineering requirements.

**a. true**

b. false

See Topic 3.

4. Label-switched path creation is done only by hop-by-hop routing.

a. true

**b. false**

See Topic 3.

5. Label merging is used for \_\_\_\_\_.

a. merging traffic on different interfaces headed for different destinations

**b. merging traffic on different interfaces headed for the same destination**

c. a and b

See Topic 3.

6. MPLS uses the following signaling mechanism \_\_\_\_\_.

**a. label request and label mapping message**

b. discovery and session message

c. advertisement and notification message

d. all of the above

See Topic 3.

7. In LDP, downstream routers initiate the distribution of labels and label/FEC bindings.

**a. true**

b. false

See Topic 4.

8. Label swapping occurs only at the edges of the network—i.e., at the LERs only.

a. true

**b. false**

See Topic 4.

9. MPLS supports creation of tunnels so that it can control the entire path of a packet \_\_\_\_\_.

a. without explicitly specifying the intermediate routers but only on the same network segment

**b. without explicitly specifying the intermediate routers that can span multiple network segments**

c. but it needs to explicitly specify the intermediate routers and is limited to the same network segment

d. but it needs to explicitly specify the intermediate routers that can span multiple network segments

See Topic 4.

10. The following routing protocol can be used for initial route setup

\_\_\_\_\_.

- a. OSPF
- b. BGP
- c. ATM PNNI
- d. all of the above**

See Topic 5.

11. LDP uses \_\_\_\_\_ for reliable transmission of control data between LSR.

- a. TCP**
- b. UDP
- c. Both

See Topic 5.

12. MPLS applications include \_\_\_\_\_.

- a. network scalability
- b. traffic engineering
- c. improving network interoperability and efficiency
- d. all of the above**

See Topic 5.

## Glossary

### **ATM**

asynchronous transfer mode

### **BGP**

border gateway protocol

### **CoS**

class of service

**CR-LDP**

constraint-based label distribution protocol

**FEC**

forward equivalence class

**IETF**

Internet Engineering Task Force

**IP**

Internet protocol

**LAN**

local-area network

**LDP**

label distribution protocol

**LER**

label edge router

**LIB**

label information base

**LSP**

label switched path

**LSR**

label switched router

**MAC**

media access control

**MPLS**

multiprotocol label switching

**OSPF**

open shortest path first

**PNNI**

private network-to-network interface

**PPP**

point-to-point protocol

**QoS**

quality of service

**RSVP**

resource reservation protocol

**SONET**

synchronous optical network

**TCP**

transmission control protocol

**UDP**

user datagram protocol

**VC**

virtual channel

**VCI**

virtual channel identifier

**VP**

virtual path

**VPI**

virtual packet identifier

**VPN**

virtual private network