

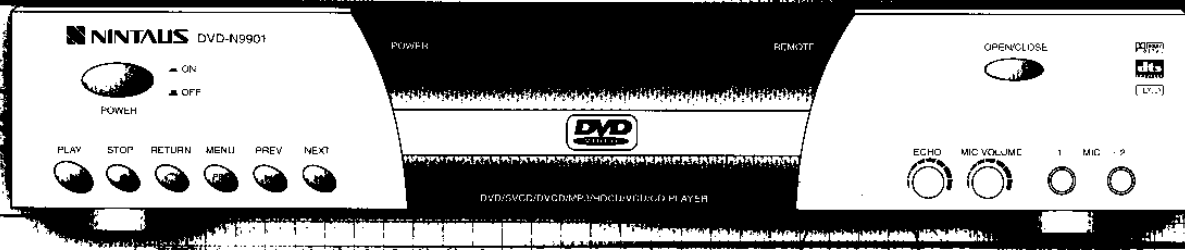

OPERATING INSTRUCTIONS

DVD-N9901



Before attempting to connect, operate or adjust this player, please read these instructions completely and save for future reference.

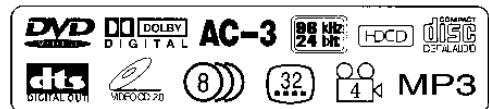

Thanks for purchasing the NINTAUS DVD player. Before operating this player, please read this manual and retain it for future reference.

SAFETY PRECAUTIONS

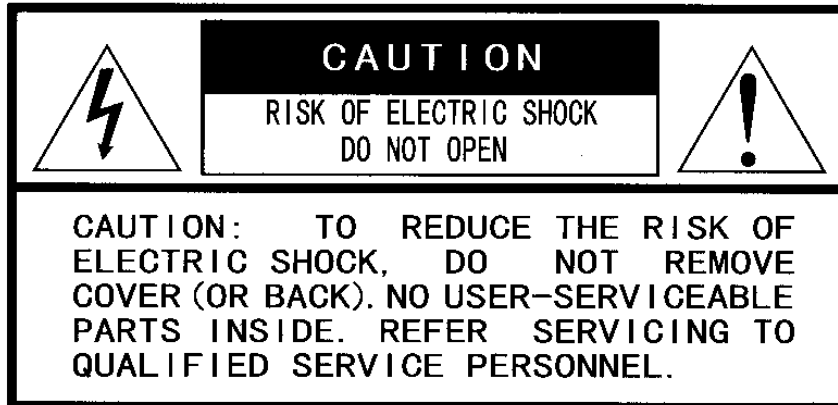

The lightning flash with arrowhead symbol, within an equilateral triangle, is intended to alert the user to the presence of un-insulated "dangerous voltage" within the product's enclosure that may be of sufficient magnitude to constitute a risk of electric shock to persons.



The exclamation point within an equilateral triangle is intended to alert the user to the presence of important operating and maintenance (servicing) instructions in the literature accompanying the appliance.

WARNING:
TO REDUCE THE RISK OF FIRE OR ELECTRIC SHOCK, DO NOT EXPOSE THIS APPLIANCE TO RAIN OR MOISTURE. DANGEROUS HIGH VOLTAGES ARE PRESENT INSIDE THE ENCLOSURE. DO NOT OPEN THE CABINET. REFER SERVICING TO QUALIFIED PERSONNEL ONLY.

CAUTION:
When replace the direct plug-in power supply or a separable, cord-connected power supply, the replacement must be exact duplicate, or one recommended by the manufacturer.



CAUTION:
TO PREVENT ELECTRIC SHOCK, MATCH WIDE BLADE OF PLUG TO WIDE SLOT, FULLY INSERT.

This Digital Video Disc player employs a laser System.

Use of controls, adjustments or the performance of procedures other than those specified may result herein hazardous radiation exposure.

To prevent direct exposure to laser beam, do not try to open the enclosure.
Visible laser radiation when open and interlocks defeated.
DO NOT STARE INTO BEAM.

FCC NOTICE:

This equipment has been tested and found to comply with the limits for a Class B digital device, pursuant to part 15 of the FCC Rule. These limits are designed to provide reasonable protection against harmful interference in a residential installation.

This equipment generates, uses, and can radiate radio frequency energy and, if not installed and used in accordance with the instructions, may cause harmful interference to radio communications.

However, there is no guarantee that interference will not occur in a particular installation.

If this equipment does cause harmful interference to radio or television reception, which can be determined by turning the equipment off and on, the user is encouraged to try to correct the interference by one or more of the following measures:

- Reorient or relocate the receiving antenna.
- Increase the separation between the equipment and receiver.
- Connect the equipment into an outlet on a circuit different from that to which the receiver is connected.
- Consult the dealer or an experienced radio/TV technician for help.

WARNING:

Changes or modifications made to this equipment, not expressly approved by NINTAUS, or parties authorized by NINTAUS, could void the user's authority to operate the equipment.

IMPORTANT SAFETY INSTRUCTIONS

CAUTION: PLEASE READ AND OBSERVE ALL WARNINGS AND INSTRUCTIONS GIVEN IN THIS MANUAL AND THOSE MARKED ON THE UNIT. RETAIN THIS BOOKLET FOR FUTURE REFERENCE.

This set has been designed and manufactured to assure personal safety. Improper use can result in electric shock or fire hazard. The safeguards incorporated in this unit will protect you if you observe the following procedures for installation, use and servicing. This unit is fully transistorized and does not contain any parts that can be repaired by the user. **DO NOT REMOVE THE CABINET COVER, OR YOU MAY BE EXPOSED TO DANGEROUS VOLTAGE. REFER SERVICING TO QUALIFIED SERVICE PERSONNEL ONLY.**

1. Read this manual

After unpacking this product, read the manual carefully, and follow all the operating and other instructions.



5. Heat

The product should be situated away from heat sources such as radiators, heat registers, stoves, or other products (including amplifiers) that produce heat.

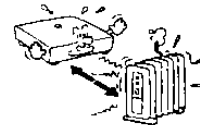

2. Power Sources

This product should be operated only from the type of power source indicated on the marking label. If you are not sure of the type of power supply to your home, consult your product dealer or local power company. For products intended to operate from battery power, or other sources, refer to the operating instructions.



6. Water and Moisture

Do not use this product near water - for example, near a bath tub, wash bowl, kitchen sink, or laundry tub; in a wet basement; or near a swimming pool and the like.

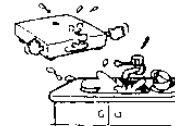

3. Grounding or Polarization

This product may be equipped with a polarized alternating current line plug (a plug having one blade wider than the other). This plug will fit into the power outlet only one way. This is a safety feature. If you are unable to insert the plug fully into the plug, contact your electrician to replace your obsolete outlet. Do not defeat the safety purpose of the polarized plug.

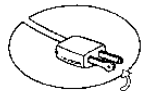

7. Cleaning

Unplug this product from the wall outlet before cleaning. Do not use liquid cleaners or aerosol cleaners. Use a damp cloth for cleaning.

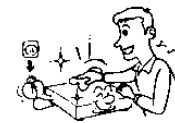

4. Ventilation

Slots and openings in the cabinet are provided for ventilation and to ensure operation of the product and to protect it from overheating, and these openings must not be blocked or covered. The openings should never be blocked by placing the product on a bed, sofa, rug or other.



8. Power-cord Protection

Power-supply cords should be routed so that they are not likely to be walked on or pinched by items placed upon or against them, paying particular attention to cords at plugs, convenience receptacles, and the point where they exit from the product.



9. Overloading

Do not overload wall outlets; extension cords, or integral convenience receptacles as this can result in a risk of fire or electric shock.



10. Lightning

For added protection for this product during storm, or when it is left unattended and unused for long periods of time, unplug it from the wall outlet. This will prevent damage to the product due to lightning and power-line surges.



16. Disc

Do not use a cracked, deformed, or repaired disc. These discs are easily broken and may cause serious personal injury and product malfunction.

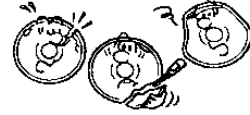

11. Object and Liquid Entry

Never push objects of any kind into this product through openings as they may touch dangerous voltage points or short-out parts that could result in a fire or electric shock. Never spill liquid of any kind on the product.



17. Damage Requiring Service

Unplug this product from the wall outlet and refer servicing to qualified service personnel under the following conditions:

- a) When the power-supply cord or plug is damaged.
- b) If liquid has been spilled, or objects have fallen into the product.
- c) If the product has been exposed to rain or water.
- d) If the product does not operate normally by following the operating instructions. Adjust only those controls that are covered by the operating instructions as an improper adjustment of other controls may result in damage and will often require extensive work by a qualified technician to restore the product to its normal operation.
- e) If the product has been dropped or damaged in any way.
- f) When the product exhibits a distinct change in performance - this indicates a need for service.

12. Attachments

Do not use attachments not recommended by the product manufacturer as they may cause hazards.

13. Accessories

Do not place this product on an unstable cart, stand, tripod, bracket, or table. The product may fall, causing serious injury to a child or adult, and serious damage to the product. Use only with a cart, stand, tripod, bracket, or table recommended by the manufacturer, or sold with the product. Any mounting of the product should follow the manufacturer's instructions, and should use a mounting accessory recommended by the manufacturer. A product and cart combination should be moved with care. Quick stops, excessive force, and uneven surfaces may cause the product and cart combination to overturn.



18. Servicing

Do not attempt to service this product yourself as opening or removing covers may expose you to dangerous voltage or other hazards. Refer all servicing to qualified service personnel.



14. Disc Tray

Keep your fingers well clear of the disc tray as it is closing. Neglecting to may cause serious personal injury.



19. Replacement Parts

When replacement parts are required, be sure the service technician has used replacement parts specified by the manufacturer or have the same characteristics as the original part. Unauthorized substitutions may result in fire, electric shock, or other hazards.

15. Burden

Do not place a heavy object on or step on the product. The object may fall, causing serious personal injury and serious damage to the product.

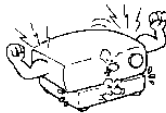

20. Safety Check

Upon completion of any service or repairs to this product, ask the service technician to perform safety checks to determine that the product is in proper operating condition.

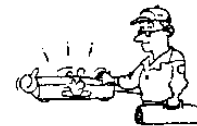

Notes on Handing

- When shipping the DVD video player, the original shipping carton and packing materials come in handy. For maximum protection, repack the unit as it was originally packed at the factory.
- Do not use volatile liquids, such as insect spray, near the DVD video player. Do not leave rubber or plastic products in contact with the DVD video player for a long time. They will leave marks on the finish.
- The top and rear panels of the DVD video player may become warm after a long period of use. This is not a malfunction.
- When the DVD video player is not in use, be sure to remove the disc and turn off the power.
- If you do not use the DVD video player for a long period, the unit may not function properly in the future. Turn on and use the DVD video player occasionally.

Notes on Locating

- When you place this DVD video player near a TV, radio, or VCR, the playback picture may become poor and the sound may be distorted. In this case, place the DVD video player away from the TV, radio, or VCR.

Notes on Cleaning

Use a soft, dry cloth for cleaning.

- For stubborn dirt, soak the cloth in a weak detergent solution, wring well and wipe. Use a dry cloth to wipe it dry. Do not use any type of solvent, such as thinner and benzine, as they may damage the surface of the DVD video player.
- If you use a chemical saturated cloth to clean the unit, follow that product's instructions.

To Obtain a Clear Picture

The DVD video player is a high technology, precision device. If the optical pick-up lens and disc drive parts are dirty or worn down, the picture quality becomes poor. To obtain a clear picture, we recommend regular inspection and maintenance (cleaning or parts replacement) every 1,000 hours of use depending on the operating environment. For details, contact your nearest dealer.

Notes on Moisture Condensation

Moisture condensation damages the DVD video player. Please read the following carefully.

Moisture condensation occurs, for example, when you pour a cold drink into a glass on a warm day. Drops of water form on the outside of the glass. In the same way, moisture may condense on the optical pick-up lens inside this unit, one of the most crucial internal parts of the DVD video player.

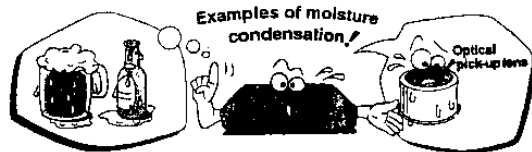

Moisture condensation occurs during the following cases.

- When you bring the DVD video player directly from a cold place to a warm place.
- When you use the DVD video player in a room where you just turned on the heater, or a place where the cold wind from the air conditioner directly hits the unit.
- In summer, when you use the DVD video player in a hot and humid place just after you move the unit from an air conditioned room.
- When you use the DVD video player in a humid place.

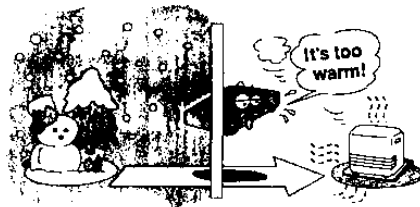

Do not use the DVD video player when moisture condensation may occur.

If you use the DVD video player in such a situation, it may damage discs and internal parts. Remove the disc, connect the power cord of the DVD video player to the wall outlet, turn on the DVD video player, and leave it for two or three hours. After two or three hours, the DVD video player will have warmed up and evaporated any moisture. Keep the DVD video player connected to the wall outlet and moisture condensation will seldom occur.



CONTENTS

Introduction	
SAFETY PRECAUTIONS	1-2
IMPORTANT SAFETY INSTRUCTIONS	3-5
<hr/>	
Operating interface	7-10
Front panel	
Back panel output	
Remote control unit	
VFD display	
<hr/>	
Disc formats can be supported	10
Reference guide	11
<hr/>	
Preparation before playing	11-15
Accessories	
Battery installation for remote Control unit	
system connection	
<hr/>	
Basic operation	15-18
Playing a disc	
Program selection	
<hr/>	
Function buttons operation	18-24
Stop & resume	
Pause & step	
Fast forward & fast rewind	
Slow forward & slow rewind	
A-B repeat	
Repeat	
Digest	
Zoom	
Return	
Menu	
Title	
Direction & select	
Angle	
Dubbing & subtitle	
Audio channel	
Mute & volume control	
3D surround	
OSD	
PAL & NTSC	
Clear	
<hr/>	
How to set up system	24-27
Set up the state of OSD	
Set up default subtitle	
Set up default dubbed language	
Set up video output	
Select signal system	
Set up audio output mode	
Set up parents passwords lock	
Set up "sub woofer" & "Pro logic"	
<hr/>	
About programing function	28
Programming play back for SVCD, VCD, CD disc	
programming playback for DVD disc	
<hr/>	
About searching function	28-30
For DVD disc	
For SVCD / VCD / CD disc	
<hr/>	
About KARAOKE function	31
To connect micro phone	
Start KARAOKE	
To Operate the special function of KARAOKE	
<hr/>	
About game function	32
<hr/>	
Malfunction & Remedy	32
<hr/>	
DVD introduction and features	33-35
<hr/>	
Disc reference	35-36
<hr/>	
Specification	37
<hr/>	

1. OPERATING INTERFACE

FRONT PANEL:

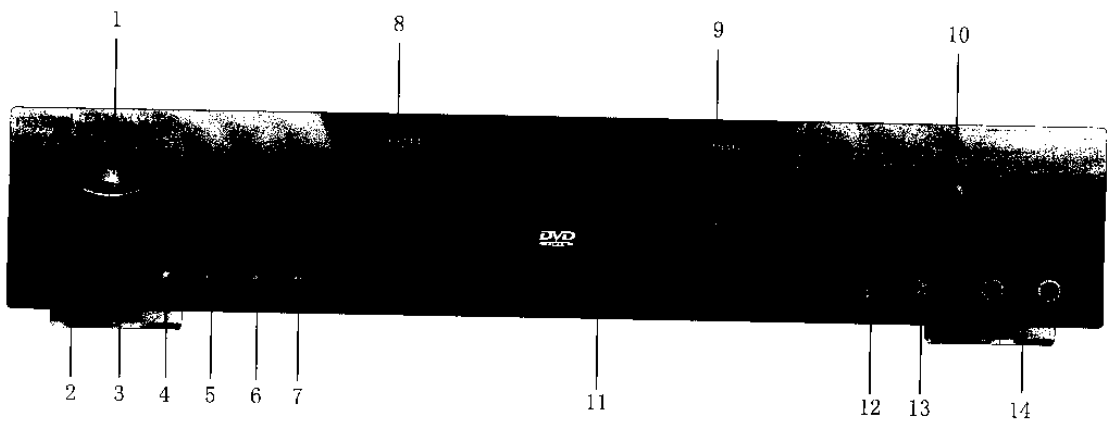

- | | |
|--------------------|---------------------------------|
| 1. POWER button | 8. Power indicator |
| 2. PLAY button | 9. Remote control signal sensor |
| 3. STOP button | 10. OPEN/CLOSE button |
| 4. RETURN button | 11. Disc tray |
| 5. MENU button | 12. ECHO control |
| 6. PREVIOUS button | 13. MIC volume control |
| 7. NEXT button | 14. MIC jacks(1,2) |

BACK PANEL OUTPUT:

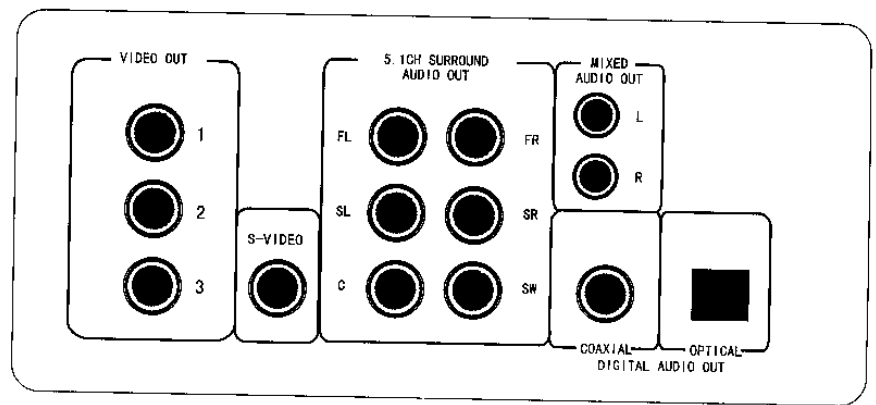

REMOTE CONTROL UNIT:

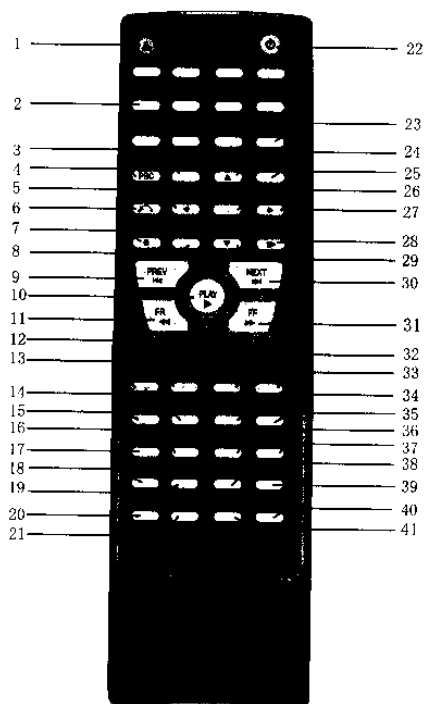

- | | |
|------------------------|------------------------|
| 1.OPEN/CLOSE button | 22.POWER button |
| 2.NUMBER buttons | 23.CLEAR button |
| 3.TITLE button | 24.UP button |
| 4.MENU button | 25.SETUP button |
| 5.LEFT button | 26.SELECT button |
| 6.RETURN button | 27.RIGHT button |
| 7.STOP button | 28.PAUSE/STEP button |
| 8.RESUME button | 29.DOWN button |
| 9.PREVIOUS button | 30.NEXT button |
| 10.PLAY button | 31.FAST FORWARD button |
| 11.FAST REWIND button | 32.ZOOM button |
| 12.SLOW FORWARD button | 33.DIGEST button |
| 13.SLOW REWIND button | 34.REPEAT button |
| 14.PROGRAM button | 35.A-B REPEAT button |
| 15.SEARCH button | 36.AUDIO button |
| 16.SUBTITLE button | 37.DUBBING button |
| 17.ANGLE button | 38.GAME button |
| 18.PAL/NTSC button | 39.KARAOKE button |
| 19.OSD button | 40.VOLUME control(+) |
| 20.MUTE button | 41.VOLUME control(-) |
| 21.3D SURROUND button | |

VFD DISPLAY:

You may see the rolling illustration as "welcome to nintaus" when the player is reading the disc.

1. For DVD

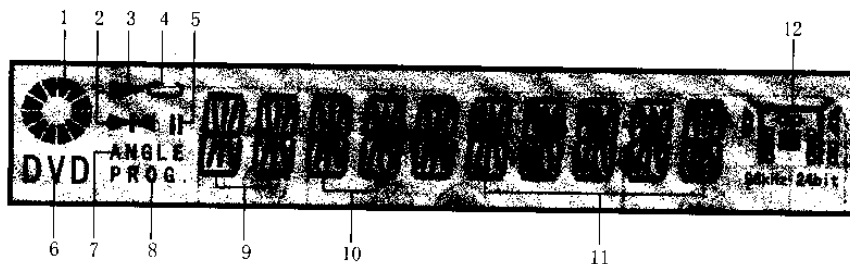

- | | |
|-------------------------------------|----------------------------------|
| <1>rolling playing display | <7>angle display |
| <2>slow forward,slow rewind display | <8>program display |
| <3>playing display | <9>title display |
| <4>repeat display | <10>chapter display |
| <5>pause display | <11>time display |
| <6>DVD display | <12>multi-channel analog display |

2. For SVCD disc

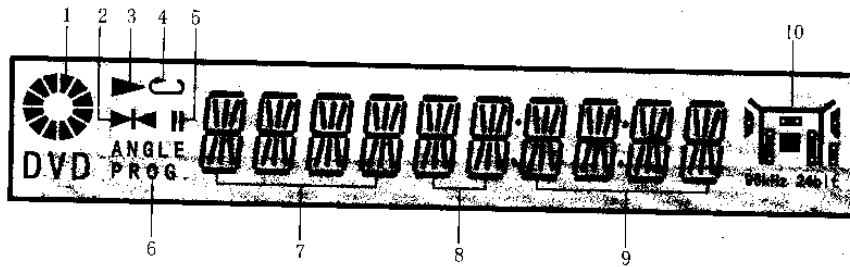

- <1>rolling playing display
- <2>slow forward,slow rewind display
- <3>playing display
- <4>repeat display
- <5>pause display
- <6>program display
- <7>SVCD display
- <8>track display
- <9>time display
- <10>multi-channel analog display

3. For VCD/DVCD disc

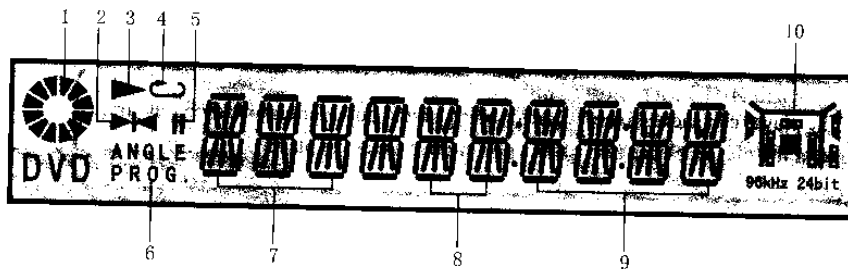

- <1>rolling playing display
- <2>playing display
- <3>playing display
- <4>repeat display
- <5>pause display
- <6>program display
- <7>VCD display
- <8>track display
- <9>time display
- <10>multi-channel analog display

4. For HDCD/CD disc

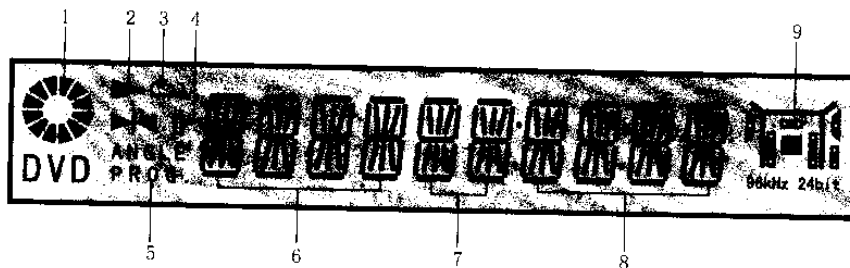

- <1>rolling playing display
- <2>Playing display
- <3>repeat display
- <4>pause display
- <5>program display
- <6>HDCD/CD display
- <7>track display
- <8>time display
- <9>multi-channel analog display

5.For MP3 disc

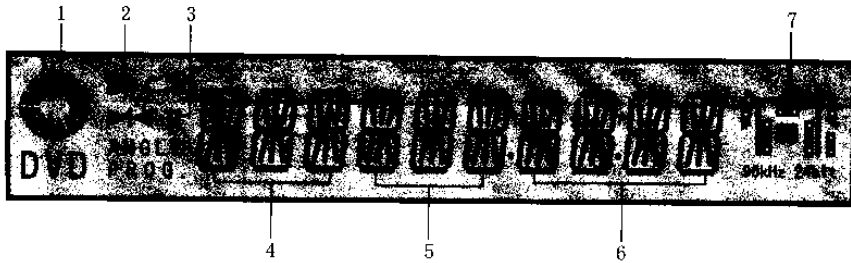

<1>rolling playing display
<2>playing display
<3>pause display
<4>MP3 display







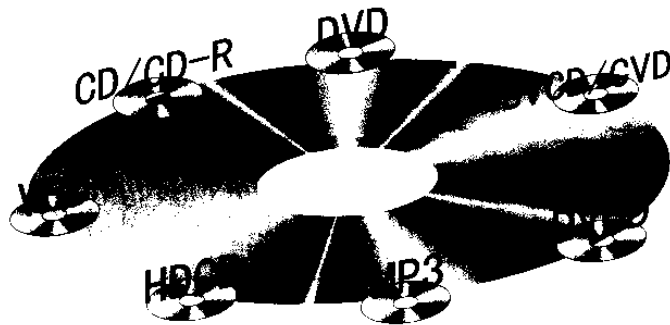

<5>track display
<6>time display
<7>multi-channel display

The player can successively work for many hours, but in order to prolong the life time of the player, please turn off the power after using the player .

2.DISC FORMATS CAN BE SUPPORTED



3. REFERENCE GUIDE

	Compatible with DVD discs
	Compatible with SVCD discs
	Compatible with DVCD discs
	Compatible with MP3 discs
	Compatible with HDCD discs
	Compatible with VCD discs
	Compatible with CD discs
	Compatible with CD-R discs

4. PREPARATION

4.1 ACCESSORIES. (Please check and identify the supplied accessories.)

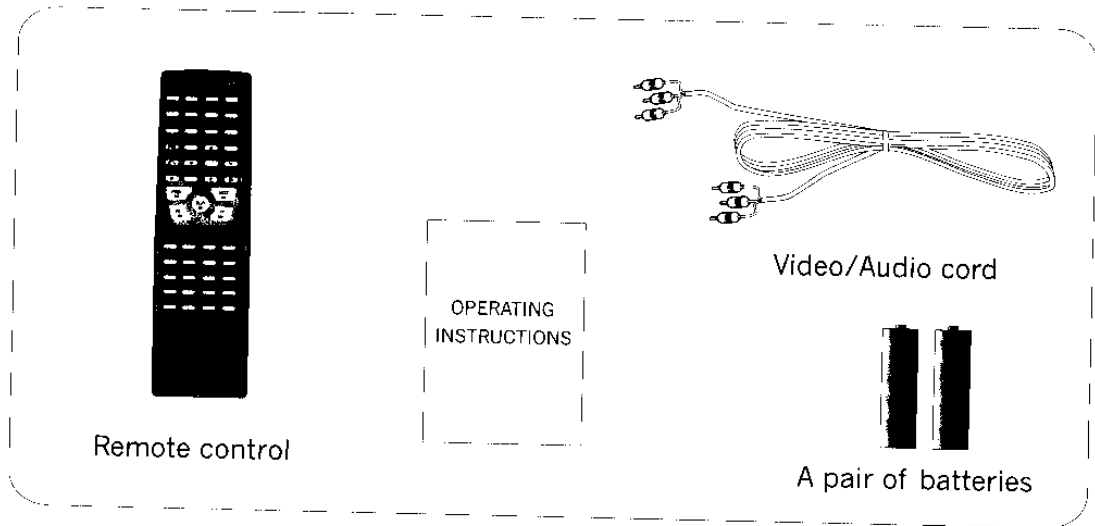

4.2 BATTERY INSTALLATION FOR REMOTE CONTROL

Insert the batteries according to the illustration. Please point at the remote sensor at the player while you use the remote controller.

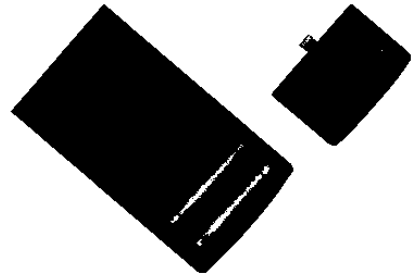

4.3 SYSTEM CONNECTION

1. Turn off the power before connection.
 2. Turn on the power after finishing connection.
- *Audio/Video cord must be connected according to its color.

- Yellow plug --- Video
- White plug --- left Audio
- Red plug --- right Audio

Connect with TV

1. Normal connection

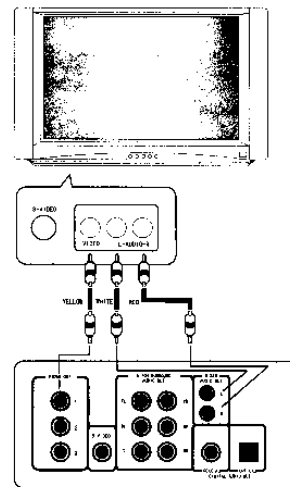

2. S-Video connection

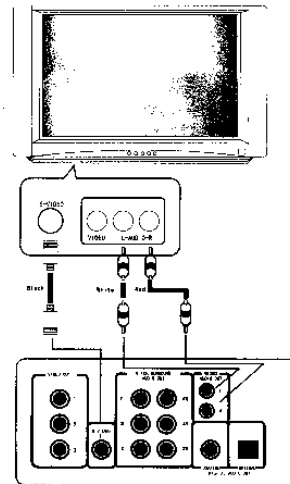

Connect one end of the s-video wire with s-video output socket on DVD back-panel and another with the s-video input socket of TV, and then connect audio wire with TV through the above two connection modes.

Note: The mixed audio output of left channel and right put out through connecting with ML and MR output as the above two connecting ways.

3.If your player has the " SCART AV OUT " connector, please connect as below:

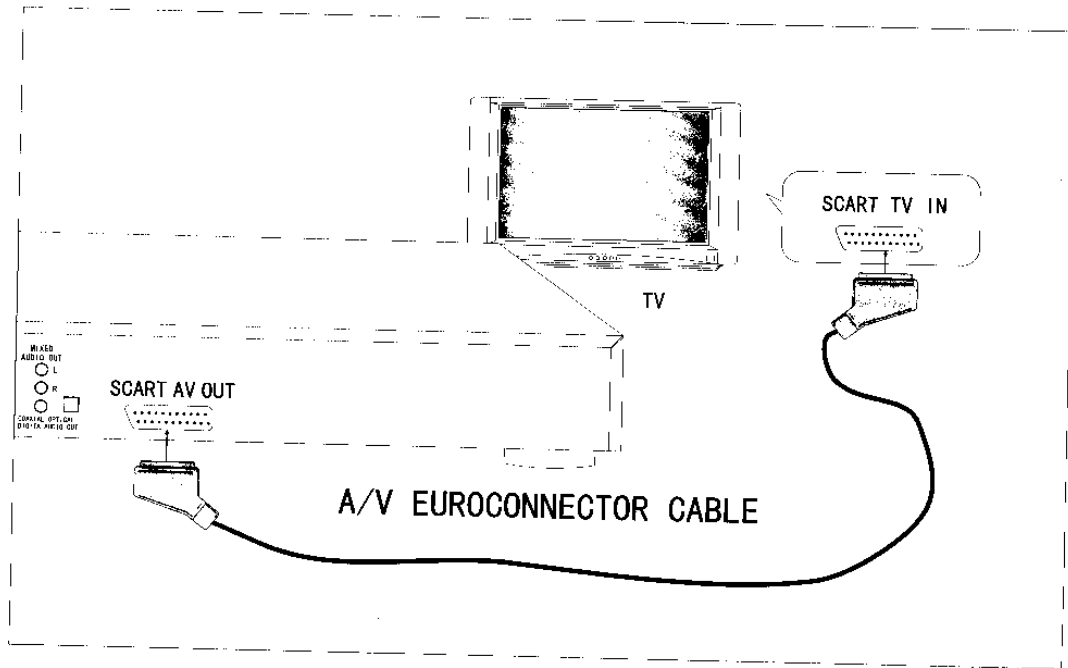

Connection to a TV with an A/V Euroconnector socket.

- 1.Connect the A/V Euroconnector on the rear of the player to the corresponding connector on the TV using the cable supplied.
- 2.Optionally you can also connect the audio Left and Right channel sockets on the rear of the player to the corresponding sockets on your stereo system.

NOTE:

If you use this method to connect , the SCART OUT should be set to RGB state as demonstrated in the right side.

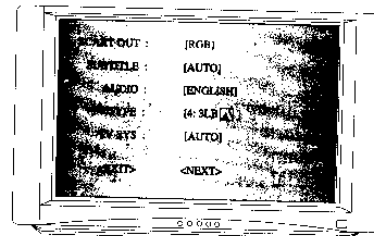

Connect with AV power amplifier

1. Normal connection.

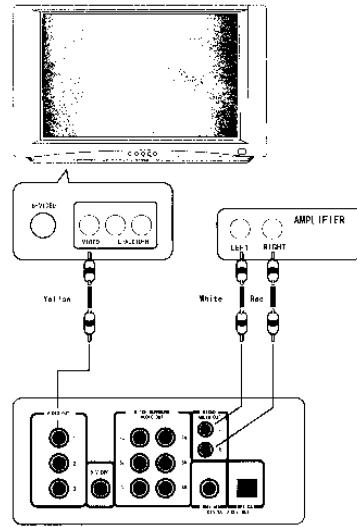

2. Connect with 5.1 channel surround sound system AV amplifier.

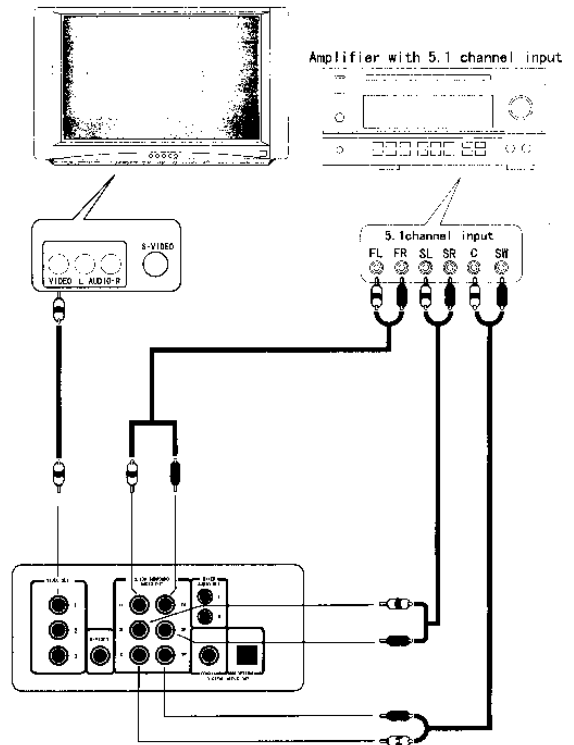

3. Connect with optical-digital audio terminal or coaxial terminal.
 Directly connect the optical-digital audio cord or the coaxial cord of the AV amplifier with those of the DVD player, then, connect the video cord of the player with the TV. video input socket .

4.4 TV SIGNAL SYSTEM

If pictures are not full screen or edge of the pictures have been covered or TV white-black phenomenon exist, please choose PAL or NTSC in the "TV SYS" column. See no. 5, system selection in VI, system setting up.

Pictures are possibly to be not full screen or partially covered, because DVD discs can support different picture proportion.

5. BASIC OPERATION

Preparation:

1. Switch the TV on and select "video input".
2. Switch the amplifier power on if the player has been connected with AV amplifier.
3. Connect the power wires of the player with the socket.

Turn on the player

1. Press "POWER" button to switch on the power then it will read disc as illustrated in the right side.

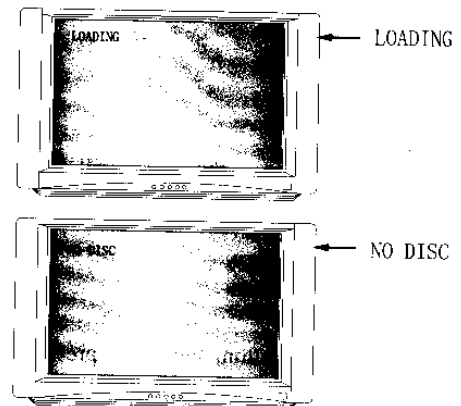
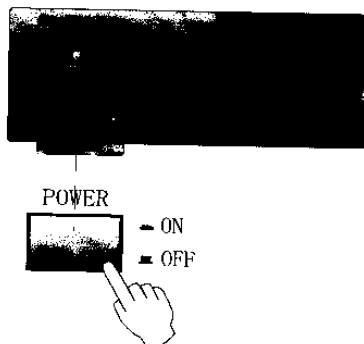

2. Press "OPEN/CLOSE" button to open the disc tray.

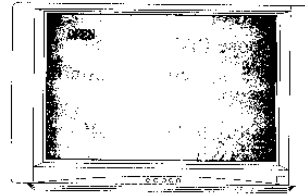
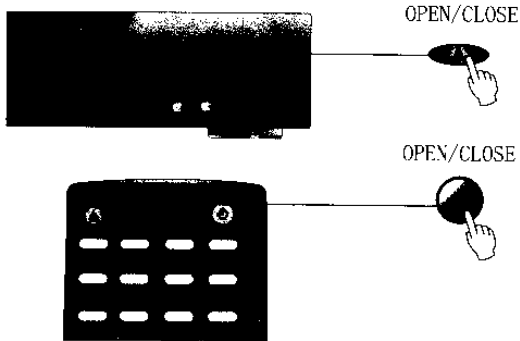

3. Place a disc into the disc tray and then press "OPEN/CLOSE" button to close the disc tray. The player can discern different kinds of discs, and you can get disc information on TV screen or on the VFD screen of the player.

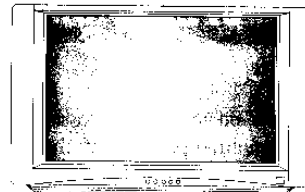
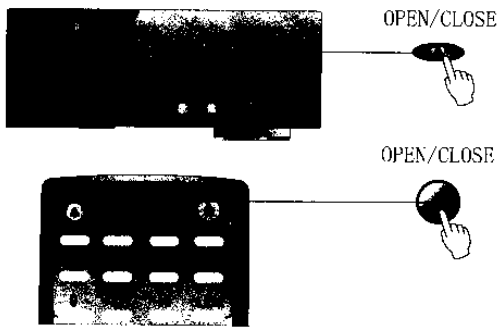
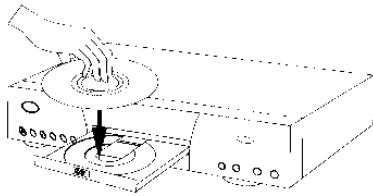

4. After loading, the disc will be played automatically, or press other button to begin other operation.

Turn Off

Press "STOP" button, and then press "OPEN/CLOSE" button to open the disc tray, take the disc out, close the disc tray, and then press "POWER" button to turn off the player.

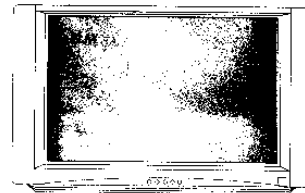

5.1 PLAYING A DISC

1. PLAY

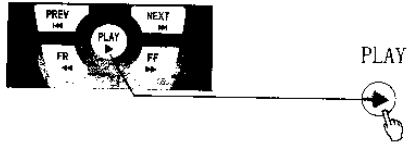
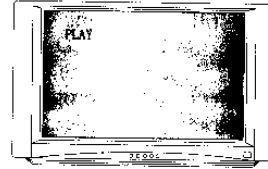

2. STOP

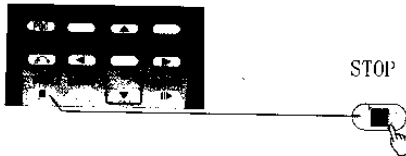
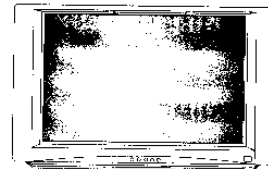

3. NEXT

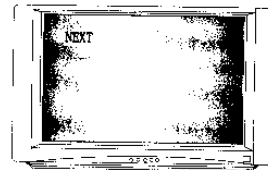

4. PREV

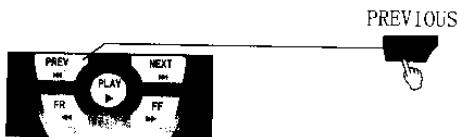
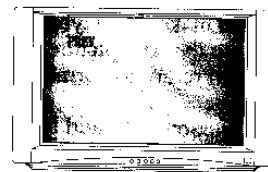

5.2 PROGRAM SELECTION

There are many titles including many chapters in a DVD disc, while SVCD, VCD and CD are only divided as tracks. Not only can you use its title, chapter and track list to get the program you want, but also use the "time setup" function. Refer to the ninth chapter "About searching function" for details.

Note: DVD time includes hour, minute and second. VCD, SVCD and CD only include minute and second.

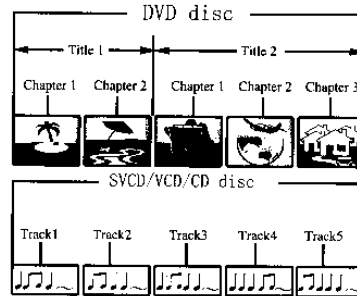

6. FUNCTION BUTTONS OPERATION

6.1 STOP, RESUME

Press "STOP" button, the player will start the resume-stop automatically. In this case, if you press "RESUME" button, the player will start the program.

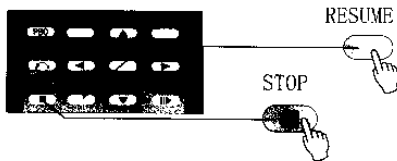

For SVCD, DVCD and VCD, when PBC is on, pressing this button will completely stop the program. Under this condition there is no resume function. In addition, press "SETUP" button to enter into setting menu, the player will automatically set up the memory-stop state. Cancel this set up, the RESUME button can be used to continue playing from the point where you stopped. (More details are in " 7. How to set up system ")

6.2 PAUSE/STEP

Press this button to make the playback still, then go on to press it to enter into the next picture one by one and press "PLAY" button will return to normal play mode.

Note: The step function is invalid for HDCD/CD disc.

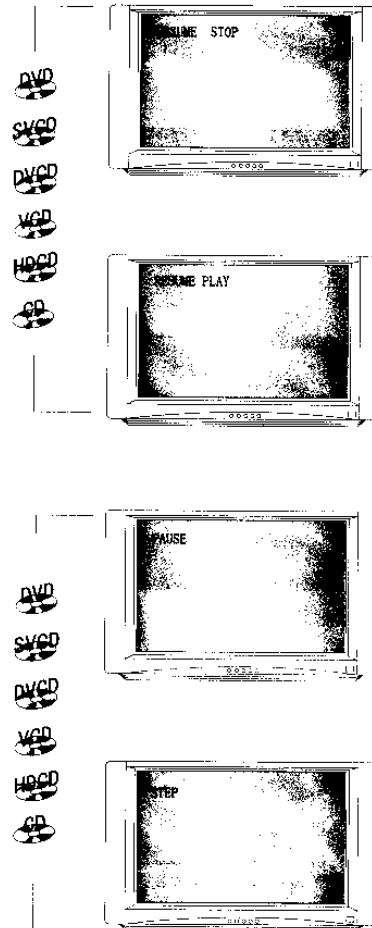

6.3 FAST FORWARD & FAST REWIND

FAST FORWARD:

Press the "FF" button on the remote controller to play at x2 speed, press it again to get x4 speed, press it the third time to get x8 speed, and press it next time to get x20 speed. Press "PLAY" button to return to normal play mode. For HDCD&CD, the fast forward modes are as follows: x2 speed, x4 speed and x8 speed.

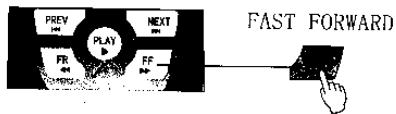

FAST REWIND:

Press the "FR" button on the remote controller to fast rewind at x2 speed, again to get x4 speed, third time to get x8 speed, and next time to get x20 speed. Press "PLAY" button to return to normal play mode. For HDCD&CD, the fast rewind modes are as follows: x2 speed, x4 speed and x8 speed.

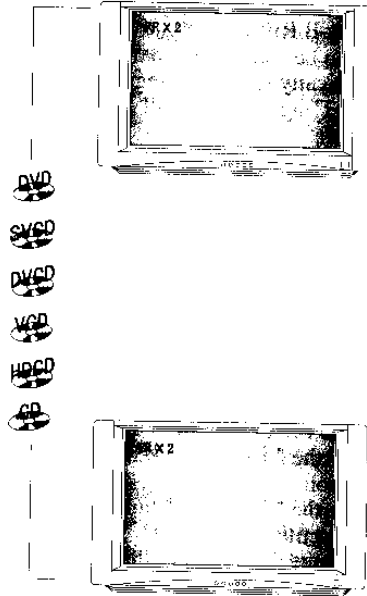
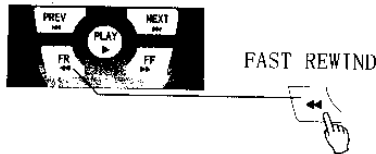

6.4 SLOW FORWARD & SLOW REWIND

SLOW FORWARD:

In the play state, continuously press the "SLOWF" button, you will get the following state and information on the screen orderly: slow forward 1/7, 1/6, 1/5, 1/4, 1/3, 1/2. Press "PLAY" button to return to normal play state.

Go on pressing the "SLOWR" button, you will get the following state and information on the screen orderly: slow rewind 1/7, 1/6, 1/5, 1/4, 1/3, 1/2. Press "PLAY" button to return to normal play state.

Note: This function is invalid for HDCD & CD disc.

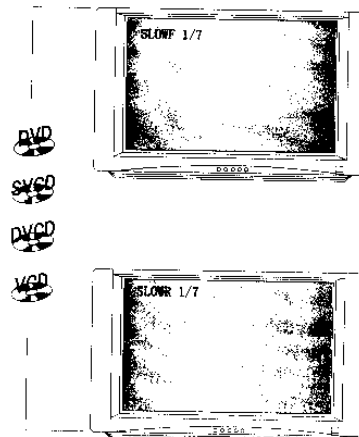
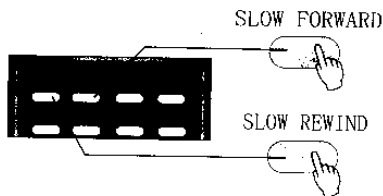

6.5 A-B REPEAT

Press "A-B REPEAT" button one time during playing, at the point where repeat play is to commence (marked A). Press "A-B REPEAT" button at the point where repeat play is to be concluded (marked B). Then the player can automatically repeat the segment from A to B. Press "A-B REPEAT" again, this will cancel the "A-B REPEAT" operation.



6.6 REPEAT

IN DVD PLAYING MODE:

1. Press the "REPEAT" button one time to cancel repeat function.
2. Press the "REPEAT" button two times to repeat the current title.
3. Press the "REPEAT" button three times to cancel repeat function.

IN SVCD& VCD PLAYING MODE:

1. Press "REPEAT" button one time to cancel repeat function.
2. Press "REPEAT" button two times to repeat one track. When the track is over, the player will repeat it automatically.
3. Press "REPEAT" button three times to repeat all the disc. When the whole disc is over, the player will repeat it automatically.



6.7 DIGEST

When playing press this button to introduce 9 pictures by single track.

Press this button to introduce 9 pictures of the whole disc when in the state of stop or PBC on.

Note: This function is invalid for DVD and CD discs.

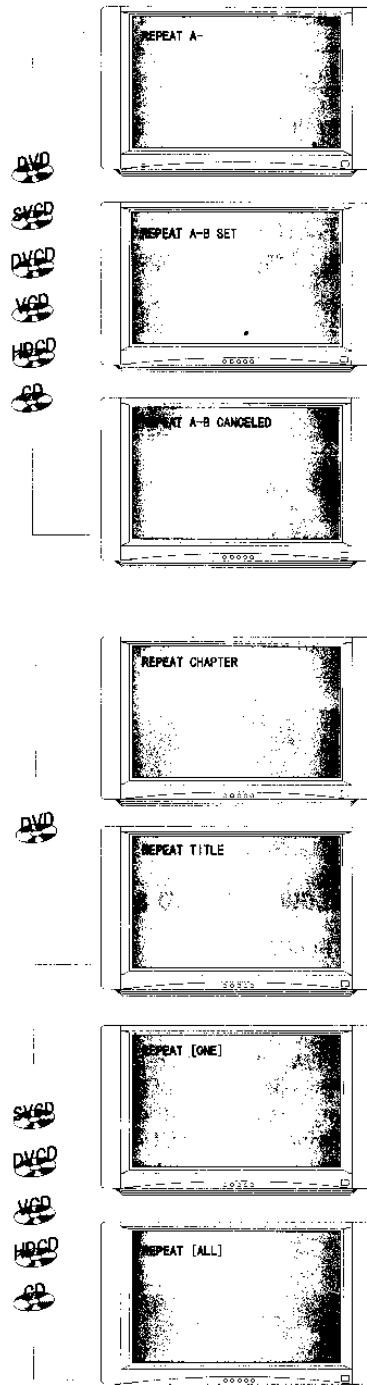

6.8 ZOOM

Go on pressing ZOOM button to get different zoomed pictures.

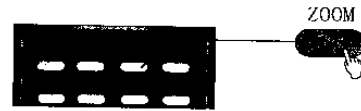

6.9 RETURN

Press this button to return the column you want, but this function is only applicable to SVCD and VCD discs.



6.10 MENU

1. For DVD disc, press this button to play the appointed programme.
2. For SVCD and VCD 2.0 discs, press this button, the player will enter into menu playback and order-ly playback .
3. This function is applicable to VCD1.1 and CD discs.

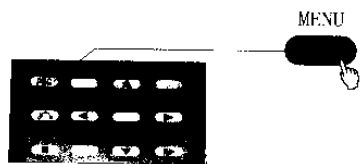

6.11 TITLE (applicable only to DVD)

Press this button to play the appointed title. (only applicable to the discs with this function)

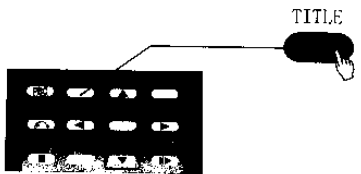

6.12 DIRECTION & SELECT

Press this button to choose the appointed column you want, then press "SELECT" button after confirmation.

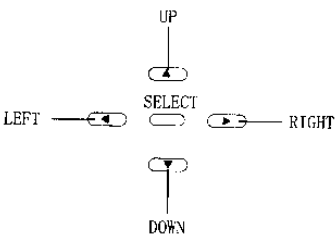

6.13 ANGLE

Press this button, the same scene can be watched from different angles, when you enjoy sport, musical or drama programs.

Note: This function only applicable to discs which have scenes recorded at different angles.

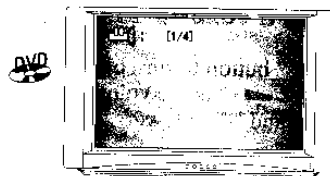
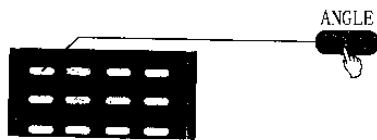

6.14 DUBBING & SUBTITLE

1. Press "AUDIO" button to select different dubbed languages. There are no less than 8 kinds of languages for DVD disc and 4 kinds of languages for SVCD disc. This function only applicable to discs with this function.

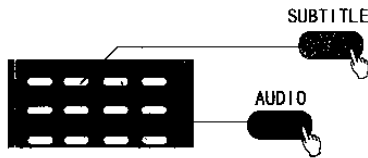

2. Press "SUBTITLE" button to select different subtitles. There are no less than 32 kinds of subtitles for DVD disc and 4 kinds of subtitles for SVCD disc. This function only applicable to discs with multi-subtitle.

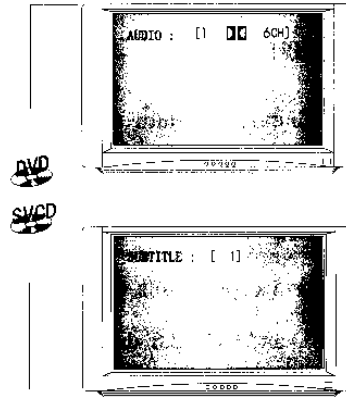

6.15 AUDIO CHANNEL

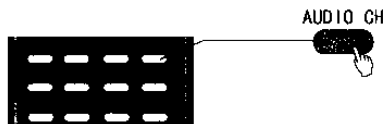

Press this button to select different subtitles as follows:

1. AUDIOCH:[STEREO]
2. AUDIOCH:[LEFT CHANNEL]
3. AUDIOCH:[RIGHT CHANNEL]
4. AUDIOCH:[LEFT KARAOKE CHANNEL]
5. AUDIOCH:[RIGHT KARAOKE CHANNEL]

When playing KARAOKE discs of VCD, press {AUDIO CH} to cancel or resume the original sound. When choosing [LEFT PARTNER] or [RIGHT PARTNER], you will get "auto replace KARAOKE" and "auto follow KARAOKE" playing.

Note: This function may work only when choosing [2 CHANNEL] or [STEREO PCM] in the "AUDIOCH" column of setting up system.

This function does not work for DVD discs.

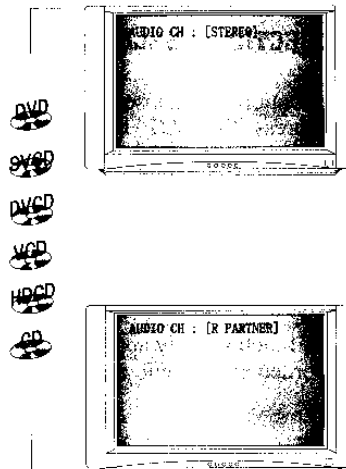

6.16 MUTE & VOLUME CONTROL

Press the "X" button to turn off sound and press again to turn on. " -> + " is the volume control button, press "+" to louder and "-" to lower.

6.17 3D SURROUND

Press "3D" on the remote controller to start 3D surround function, press it again to turn off this function.

Note: This function only works under the condition of choosing [2 CHANNEL] or [STEREO PCM] in the "AUDIO" column of setting up system.

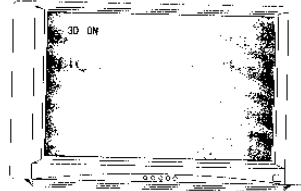

6.18 SCREEN DISPLAY

When DVD player is playing, you can press the "OSD" button continuously to choose partial display, total display and clear the display.

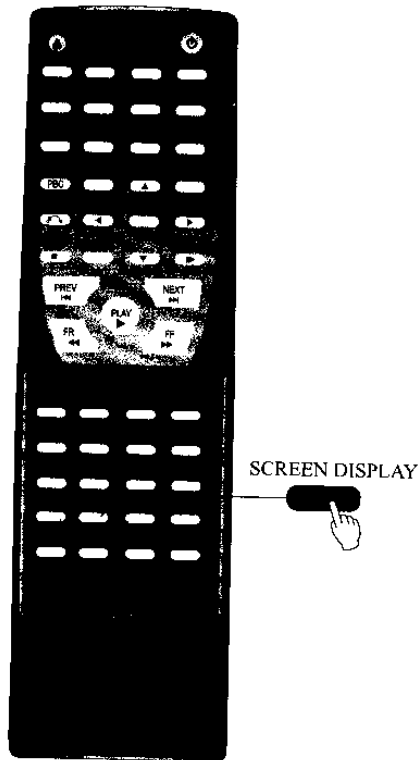

OSD:

- ← Discs' type, time for current title and remaining time

← current chapter and total chapter

← current title and total title

← the state of dubbed

← the state of subtitle

← the state of angle
- ← Discs' type, time for current track and remaining time

← current program and total program
- ← Discs' type, time for current track and remaining time

← current program and total program
- ← Discs' type, time for current track and remaining time

← current program and total program
- ← Discs' type, time for current track and remaining time

← current program and total program

6.19 SIGNAL SYSTEM

Press "N/P" button on the remote controller to switch the signal system as follows to make DVD player fit for TV set.

[AUTO] [NTSC]
[PAL] [PAL 60] [PAL 60R]

Note: Refer to the fifth item "select signal system" in "7.How to set up system".



6.20 CLEAR

When you input the numbers, press "CLEAR" button to cancel numbers inputted.



7.How to set up system

Press "SET UP" button on the remote controller to get the first picture as illustrated in the right side of this page and choose <NEXT> on the screen by pressing direction button, then press "SELECT" button on the remote controller to enter into the second picture. You may get the third picture in the same way. Under this condition, you can set up your own favorite system.

Note: DVD player will be in the state of memory-stop automatically when you press "SET UP" button, and you can resume the program by pressing "RESUME" button after you finished the operation of system's setting.

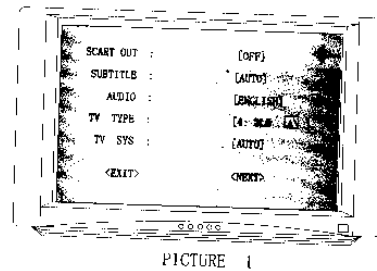

PICTURE 1

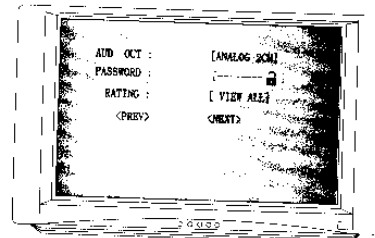

PICTURE 2

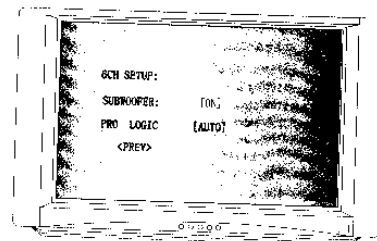

PICTURE 3

7.1 SET UP THE STATE OF SCART OUT

Press "▲" "▼" button to choose "SCART OUT" column and press "SELECT" button to get DVD Video output in three different modes (as picture 1 illustration) as:

SCART OUT [OFF]、[CVBS]、[RGB]

7.2 SET UP DEFAULT SUBTITLE

Press "▲" "▼" buttons to choose the "SUBTITLE" column and then press "SELECT" button to choose from the following:

- [Chinese] ----- Chinese subtitle
- [English] ----- English subtitle
- [AUTO] ----- Choose subtitle by machine system automatically.
- [CLOSE] ----- to close subtitle function

If the disc has different subtitles including Chinese and English, and you choose [Chinese] in the subtitle column, it will play in Chinese subtitle at first. If you choose [AUTO], the machine system will choose subtitle automatically according to different discs in the process of playing.

Note: If you don't like the default subtitle, choose the subtitle by pressing "SUBTITLE" button on the remote controller.

This function is only applicable to discs with many kinds of subtitles.

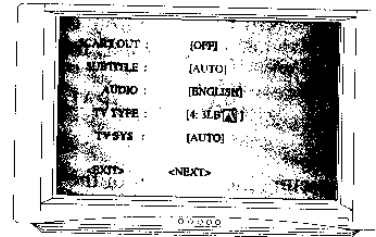

7.3 SET UP DEFAULT DUBBING LANGUAGE

Press "▲" "▼" button to choose the "AUDIO" column and then press "SELECT" button to choose from the following:

- [Chinese] ----- Chinese dubbing languages
- [English] ----- English dubbing languages

Note: You can also choose the dubbing languages you want by pressing "AUDIO" button on the remote controller. This function is only applicable to discs with many kinds of dubbed languages.

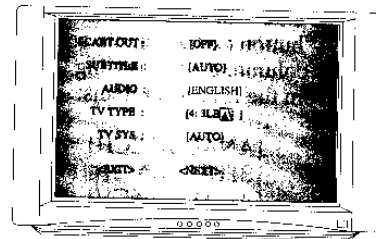

7.4 SET UP VIDEO OUTPUT MODE

Press "▲" "▼" buttons to choose the "VIDEO" column and then press "SELECT" button to choose from following:

- 4 : 3 LB Letter box mode
- 4 : 3 PS Total scene mode
- 16 : 9 Wide screen

Note: This operation is only applicable to discs with the function.

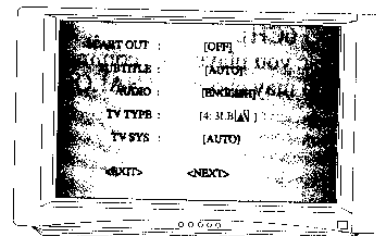

7.5 SELECT SIGNAL SYSTEM

Press the buttons “ ▲ ” “ ▼ ” to choose the “ PAL/NTSC ” column on the right of the screen and then press “ SELECT ” button on the remote control unit to choose what you want as follows:

[AUTO] [NTSC]
[PAL] [PAL60] [PAL60R]

Note:

- 1.If the picture has no color or the color is abnormal or sound/image pause instantly, this may be the result of different signal system between the player and the TV set. You may change TV signal system or discs' signal system to make them suit for each other.
- 2.Some nonstandard discs can not be played normally in the [PAL] system. You can choose [PAL60] [PAL60R] to play them.
- 3.You can also press “ N/P ” button on the remote control unit to change signal system under the state of stop.

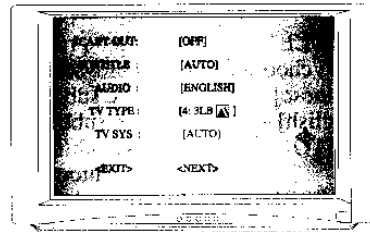

7.6 AUDIO OUTPUT SETTING MODE

Press directional button to choose <NEXT> on the screen and enter into the second interface by pressing "SELECT" button on the remote control unit, then choose "AUDIO" column, go on pressing "SELECT" button to choose from the following items:

[ANALOG 2CH]
[BITSTREAM]
[ANALOG 6CH]
[STEREO PCM]

Note:

- 1.If you connect amplifier with DVD player's optical or coaxial output, you must choose [DIGITAL] or [STEREO PCM] in "AUD OUT" column.
- 2.If you connect amplifier with DVD player ' s 5.1 channel output, and you hope to enjoy the whole effect of DOLBY 5.1 channel surround sound , just choose [ANALOG 6CH].
- 3.If the disc you played is common disc with 2 channel output, you may choose [ANALOG 2CH].

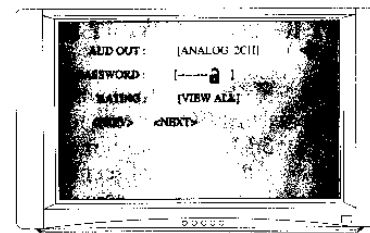
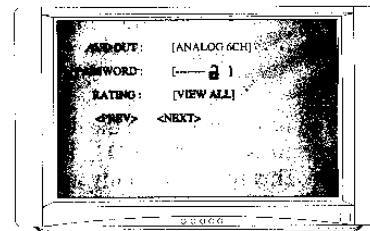
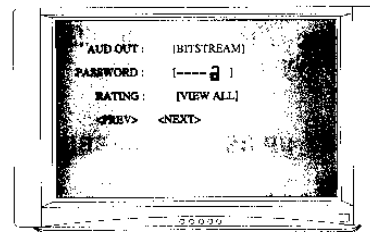

7.7 SET UP PARENTS PASSWORDS LOCK

Press direction button to choose the "degree" column of the second interface in the "system setting up", then press "SELECT" button to choose from the following:

- [NOT LIMITED]
- [NOT GRADE A DISC]
- [FOR CHILDREN]

After that, you may press direction button to make "PASSWORD" column bright and input four numbers, then lock them by pressing "SELECT" button. So locked type of discs can not be played unless your password is correct and have opened the lock by pressing "SELECT" button.

- [-----] stand for locked state
- [-----] stand for unlocked state

Note: This function is only applicable to DVD discs which have rating limited.

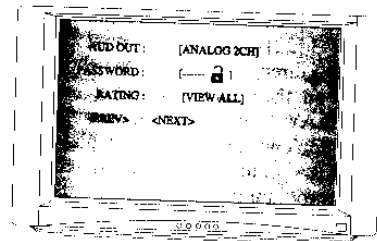
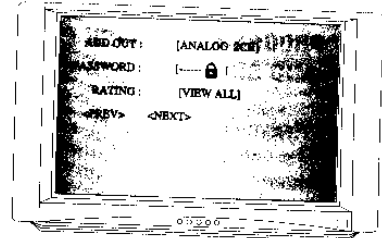

7.8 " SUPERBASS " & " PRO LOGIC " SETTING

1. Press direction button on the remote control unit to choose <NEXT> on the screen and enter into the third interface.
2. Press direction button on the remote control unit to make the "SUBWOOFER" column bright and press "SELECT" button to choose [ON] or [OFF].
3. To make the "PRO LOGIC" column bright by pressing direction button and press "SELECT" button to choose [AUTO], [ON] or [OFF].

Note:

1. "PRO LOGIC" is Dolby pro logic decoder which include five independent channel as FL, FR, C and SURROUND X 2.
2. This function only applicable to discs with this coding programme. You're suggested to use the original system setting as illustrated in the right side.

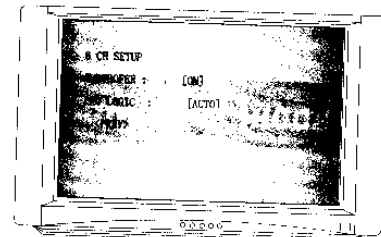

8. About programming function

8.1 PROGRAM PLAYBACK FOR SVCD, VCD AND CD DISC

Press "PROGRAM" button on the remote control unit to enter into the interface as illustrated in the right side and choose by pressing direction button, then input numbers by pressing numerical buttons. For example, if you want to play back track 2, 6, 22, you can do it as follows:

- 1 [02] ----- input 02 or 2
- 2 [06] ----- input 06 or 6
- 3 [22] ----- input 22

Pressing direction button to choose the <PLAY> column on the right side of the screen, press "SELECT" or "PLAY" button on the remote control unit to play. If you don't need programming playback, just select the <CLEAR> column and press "SELECT" button to cancel program playback, at the same time, all the inputted numbers have been cleared.

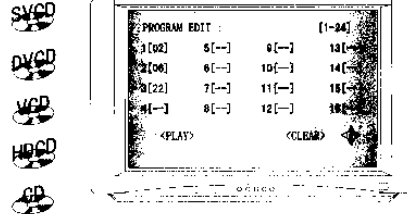

8.2 PROGRAM PLAYBACK FOR DVD DISC

Press "PROG" button on the remote control unit to enter into the interface as illustrated in the right side, the first two numbers are for title and the last two numbers are for chapter.

Note: The inputted number of titles must be no more than or equal to total number of titles or chapters.

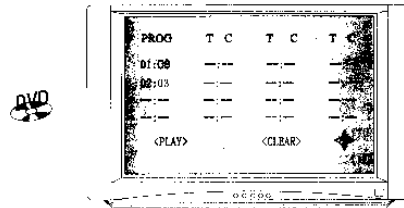

9. About searching function

To press this button can play the appointed part quickly. After input, press "SELECT" button to play the part.

9.1 FOR DVD DISC

Press "SEARCH" button on the remote control unit to enter into the interface as illustrated in the right side. Press direction button to choose the "TITLE" column then input the title numbers which you want by pressing numerical buttons. For example, input 2 to choose the second title and you will see [--- 2] on the screen, then press "SELECT" button to play it.

Note: The inputted numbers must be no more than or equal to total title's number of disc.

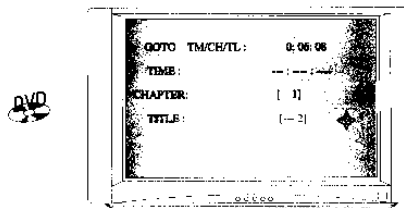

Press "▲" "▼" buttons to choose the chapter column on the screen. Input the chapter number which you want by pressing numerical buttons. For example, input number 1, 2 to choose chapter 12 and you will see [---12] in the chapter column, then press "SELECT" to play it.

Note:

1. The inputted numbers must be no more than or equal to the total chapters.

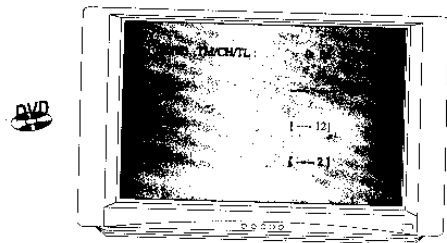
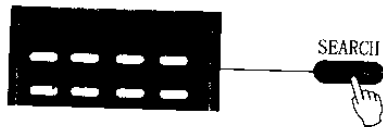

2. If the inputted numbers is less than 10, you may directly press the number. Some kinds of DVD discs have no chapter, so the operation mentioned above will be applicable. Some kinds of DVD disc only have a title, you don't need to select.

Press "▲" "▼" buttons to choose the time column on the screen. Input the time which you want by pressing numerical buttons. For example, input number 1, 0, 6, 1, 8 to choose one hour six minutes and eighteen seconds, you will see "-1: 06: 18", then press "SELECT" to play.

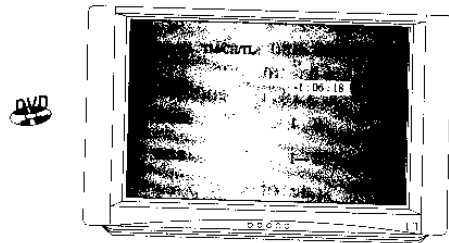

9.2 FOR SVCD/VCD/CD DISC

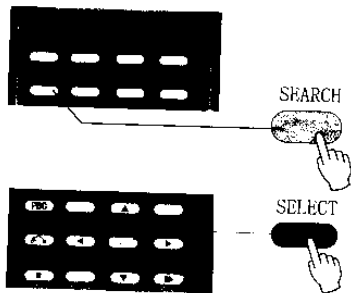

1. Single track searching (search in current track list)

Press "SEARCH" button on the remote control unit to enter into the interface as illustrated in the right side (picture 1). Input the time by pressing numerical buttons. For example, input number 1, 0, 8 to choose time of one minute and eight seconds, then you will see "-:1:08", and you can press "SELECT" to play it from the appointed time.

2. Whole disc searching (search in the whole disc)

Press "SEARCH" button on the remote control unit to enter into the interface as illustrated in the right side (picture 2). Press "▲" "▼" button to choose the "PROGRAM" column and input numbers. For example, input number 1 and 2 to choose the twelfth program, then you will see [-12] in the "PROGRAM" column, at last, press "SELECT" button to play.

Press "▲" "▼" buttons to choose the "TIME" column and input numbers of appointed time by pressing numerical buttons. For example, input number 2, 2, 1, 8 to choose the time of twenty minutes and eighteen seconds, then you will see "-: 22; 18" in the "TIME" column, so you can press "SELECT" button to play from appointed time.

Note:

1. Under the state of stop, press "SEARCH" button only can get "whole disc search".
2. For SVCD/DVCD/VCD2.0 disc, press "SEARCH" button only can get "single track search" when playing under the state of PBC ON.
3. For SVCD/DVCD/VCD2.0 disc, press "SEARCH" button one time to enter into "single track search", two times to enter into "whole disc search" when playing under the state of PBC OFF.
4. For VCD1.1 / HDCD / CD disc, press "SEARCH" button one time to enter into "single track search", two times to enter into "whole disc search" when playing.

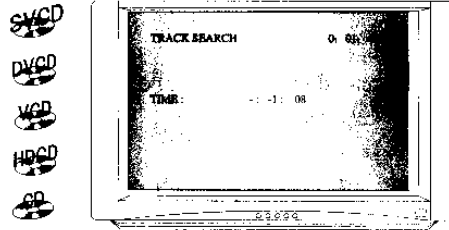

PICTURE 1

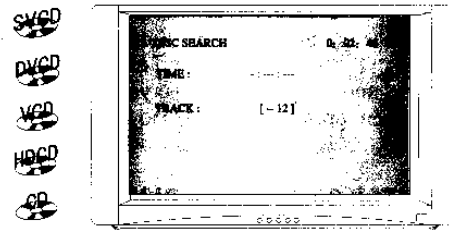

PICTURE 2

10. About KARAOKE function

10.1 TO CONNECT MICROPHONE

Turn the "MIC VOL" and "ECHO" knob on the front panel to the minimum, then connect microphones with MIC jacks. You may connect two microphones to enjoy antiphonal singing.

10.2 START KARAOKE

1. Turn the knob of "MIC VOL" to adjust the volume of microphone.
2. Turn the knob of "ECHO" to adjust the volume of echo.
3. You may press numerical buttons on the remote control unit to choose the track you want when it is playing karaoke disc.

10.3 TO OPERATE THE SPECIAL FUNCTION OF KARAOKE

To choose [2 CH] or [STEREO PCM] according to the sixth point "Audio channel output setting" of "7. How to set up system". Press "AUDIO CH" button on the remote control unit several times and choose from the following:

- [STEREO] [LEFT CHANNEL]
- [RIGHT CHANNEL]
- [LEFT REPLACE KARAOKE]
- [RIGHT REPLACE KARAOKE]

1. CANCEL ORIGINAL SOUND

You may press the "AUDIOCH" button and choose [LEFT CHANNEL] or [RIGHT CHANNEL] to cancel original sound when you are enjoying karaoke, or you can press "DUBBING" button and choose different state to cancel original sound.

2. THE OPERATION OF AUTO REPLACE KARAOKE AND AUTO FOLLOW KARAOKE
Choose [LEFT REPLACE KARAOKE] or [RIGHT REPLACE KARAOKE] to gain auto replace karaoke and auto follow karaoke.

Note: This function is not applicable to DVD discs.

Noise handling:

1. Take the microphone far away from TV set or SPEAKER.
2. Turn down the volume of TV set or SPEAKER.
3. Turn down the volume or echo of microphone.

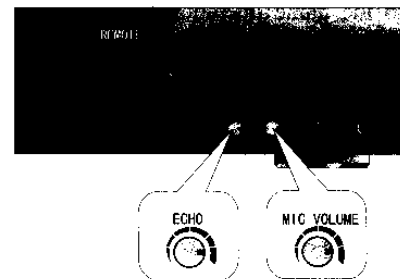
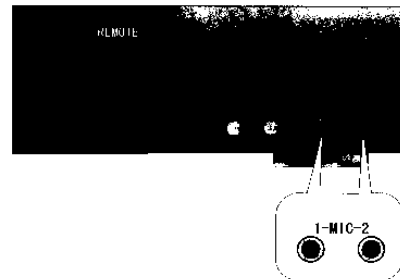

11. About game function

Press "GAME" button on the remote control unit to choose from the following:

SELECT GAME
[TETRIS]
[OTHELLO]

1. In the menu of game selection press "▲" or "▼" button to choose [TETRIS] and press "SELECT" button to enter into the game operation.

In the process of operation, you can change the direction of blocks by pressing "▲" or "▼" button and can change the situs of block by using "◀" or "▶" button, and to press "SELECT" button can make the block go down more fast.

2. Press "▲" or "▼" button to choose [OTHELLO] and press "SELECT" button to enter into the game operation. You may press the four direction buttons to change the blocks situs and place the blocks by pressing "SELECT" button.

The player will be marked as "red side". When you place the blocks, please note the green block between two red blocks. No matter in any direction, the green block will be eaten off, and the same to red block. When game is over, the total number of red and green block will be showed in the right of the screen.

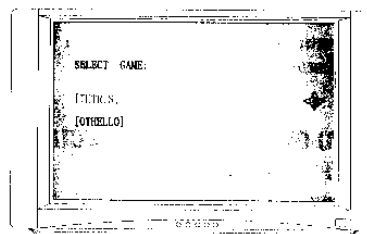

12. Malfunction & Remedy

Before requesting aftersales service try the following method to solve your problems.

No sound:

1. Ensure that the player is connected properly with the other system, such as amplifier or TV set.
2. Ensure that TV set or amplifier is working properly.
3. Ensure not pressing "MUTE" button of TV set.

No picture:

1. Ensure that the player is connected tight with the other system, such as TV set.
2. Ensure that the TV set is working properly.

Disc not playing

1. Ensure that the disc is installed correctly. (Label side is up)
2. Ensure that the disc is clean.

Microphone no sound:

Adjust up the volume of microphone to a suitable level.

Remote control does not function:

1. Remove the obstacles between the player and the remote control unit.
2. Point the remote control unit at the sensor on the front panel of the player.
3. Replace the batteries.

No display or has partial display:

1. Check if the disc is deformed and ensure that the disc is clean.
2. When mistake has happened, please turn off the power and open the player again after several seconds, if the mistake disappears, then the player may be work properly again.

No output when opening:

1. Ensure that the time between continuous openings is not too short.
2. Open the player again after ten seconds of closing, or press "POWER" button on the remote control unit to open the player.

13. DVD introduction and features

DVD player is the ticket of your home theatre. Every technical index of this machine is far more superior to any previous audio - visual equipment. This completely new digital technology has compressed the audio - visual effect of cinema into a 12cm diameter disc which is the same in dimension as the CD disc. Especially the Dolby digital channel output can provide prominent digital surround effect. It can also be compatible with the existing SVCE, VCD and CD.

Compare DVD disc with other discs:

	DVD				LD	SVCD	VCD	CD
Record way	Digital/MPEG II				Analog	Digital	Digital/MPEG I	Digital
Volume	Single-side single-layer 4.7G	Double-side single-layer 8.5G	Single-side double-layer 9.4G	Double-side double-layer 17G	/	650MB	650MB	650MB
Playing time	133 minutes	242 minutes	266 minutes	484 minutes	Single-side 60minutes double-side 120minutes	45minutes	74minutes	74minutes
Disc diameter	12cm/8cm				30cm/20cm	12cm	12cm	12cm/8cm
Horizontal resolution	More than 500 line				No more than 430 line	no more than 350 line	no more than 250 line	/
Picture proportion	Multiple kinds				one kind	one kind	one kind	/
Subtitle	32 kinds				16 kinds at most	4 kinds	/	/
Language	8 kinds				4 kinds at most	4 kinds at most	2 kinds	2 kinds
Sound quality	48kHz,96kHz/ 16, 20, 24bit				44.1kHz 16bit	44.1kHz/ 16bit	44.1kHz/ 16bit	44.1kHz/ 16bit

SPECIAL FUNCTIONS OF DVD

Parents lock

Some kinds of DVD disc may be harmful to children because of their contents, which can be marked by G,PG, PG-13, R or NC-17. You can limit your children to watch this kind of disc with this function.

Multiple languages

DVD disc can offer 8 kinds of language sounds and 32 kinds of language subtitles recorded at most for your choose.

Multiple chapter function









For DVD disc, you can begin the story at any time or any part with this function.

Multiple angles for viewing

You may view the scene from different angles.

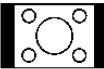
Multiple picture proportions mode

Multiple picture proportions can be suitable for different types of TV screen.

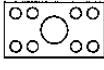
Discs image	TV SCREEN			
	4:3			16:9
	Normal	Whole screen	L-B mode	Wide-screen mode
4:3 				
16:9 				

Dolby digital(AC-3) 5.1 channel surround sound



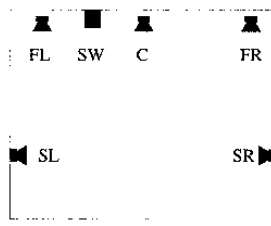





Dolby digital(AC-3) 5.1 channel surround sound (including 6 independent channels) gives the consumer 3-dimension space stereo audio appreciation, the superbass channel (subwoofer) can improve the superbass sound effects (subwoofer speaker can be placed randomly).

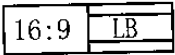

Note: "Dolby" and the double D symbol are the trademark of Dolby laboratories. It is a Confidential unpublished works ©1992-1997 Dobby laboratories. All rights reserved.

Function supported by DVD discs

Functions supported by DVD discs are so many that it may be different from different producer.

Regional code and signal system	-----	
Dolby digital surround sound	-----	
DTS output	-----	
Sort of language	-----	
Subtitle languages	-----	
Pictures proportional mode	-----	
Parents lock	-----	
Angles for viewing	-----	
Close subtitle	-----	







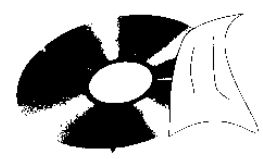



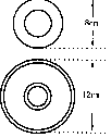

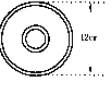

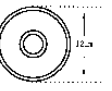
14. Disc reference

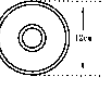
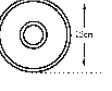
Disc protection :

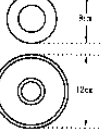
1. Hold the disc by the edges so the surface will not be damaged with finger prints.
2. Do not stick scraps of paper to the disc surface.
3. Wipe the disc with a dry soft cloth from the center hole toward the outer edge.
4. Be sure not to bend the disc and store in the box.
5. Do not store the disc in the following places : areas exposed to direct sunlight, humid or dusty areas.

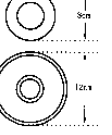

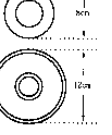
The following discs can be played:

DISCS	DIMENSION	LABEL
DVD		
SVCD		
DVCD		
MP3		MP3
HDCD		
Video-CD (VCD)		
CD-DA		
CD-R		

15. SPECIFICATION

VF Signal system	AUTO/NTSC/PAL/PAL60/PAL60R	
Audio response	20Hz-20kHz	
Audio s/n ratio	>90dB	
Output	Audio output (analog audio)	Electric level output : 1.8V resistance : 10K Ω
	Audio output (digital audio)	Electric level output : 0.5Vp-p resistance : 75 Ω
	Video output	Electric level output : 1Vp-p resistance : 75 Ω Unbalanced negative
	S-Video output	Electric level output : brightness(Y) 1Vp-p, chrominance(C): 0.286Vp-p, resistance : 75 Ω
Input	Microphone X 2	
Power	~ 220v, 50Hz	
Power consumption	<30W	
Dimensions	430 (L) X 295 (W) X 75 (H) mm	
Weight	4.0 Kg	

DVD PLAYER

 **NINTAUS®**
NINTAUS ELECTRONICS CO., LTD.

0 1 1 0 0 1 0 0

0 1 1 0 0 1 0 0

0 1 1 0 0 1 0 0