

Número de eslabones	Número de Grupos de Assur
2	1
4	2
6	10
8	173
10	5442
12	251638
14	-

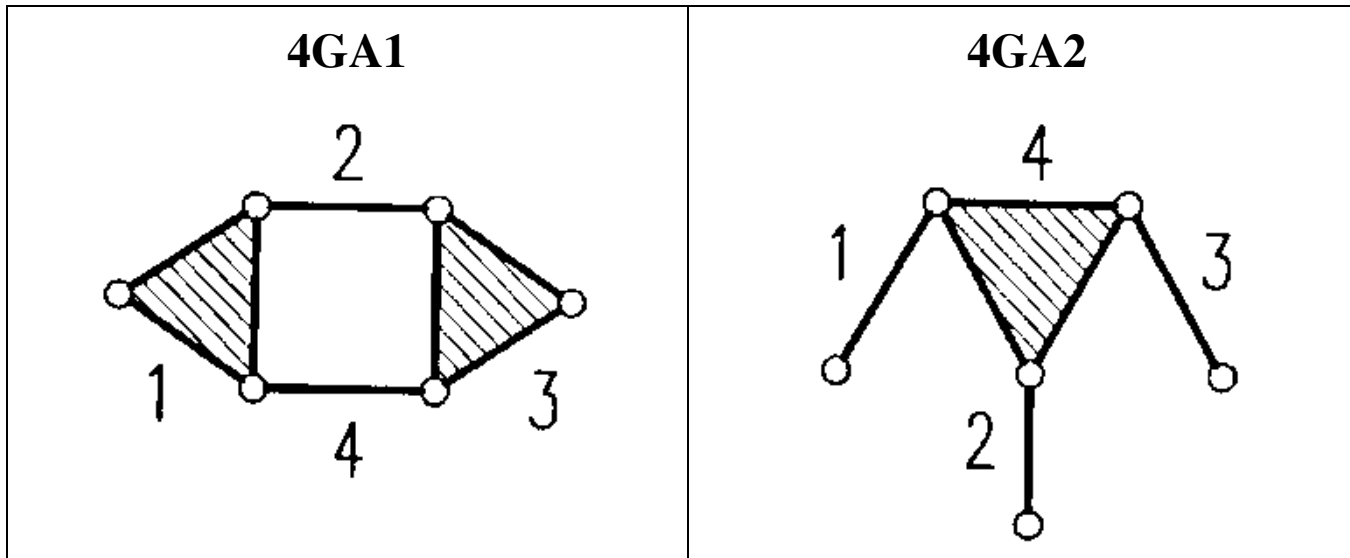

Grupos de Assur de cuatro eslabones

6GA1

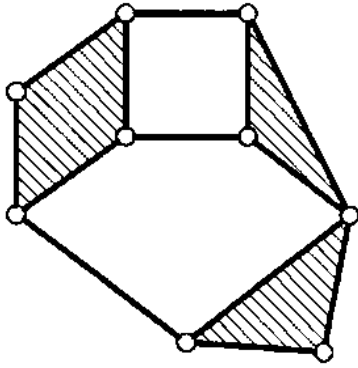

6GA2

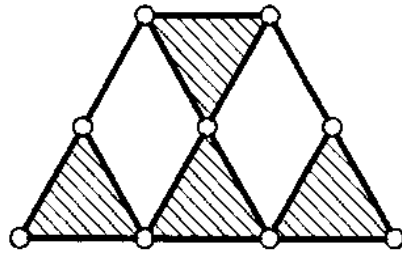

6GA3

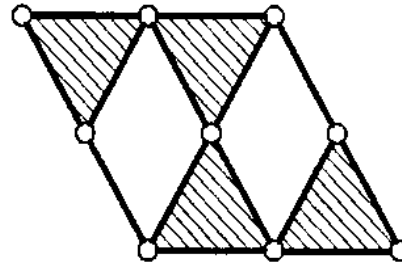

6GA4

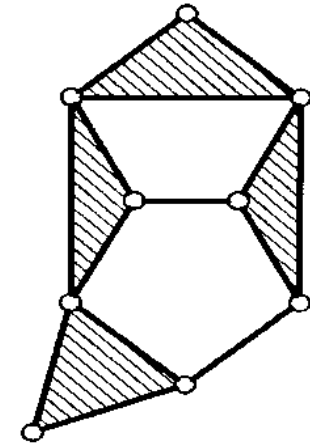

6GA5

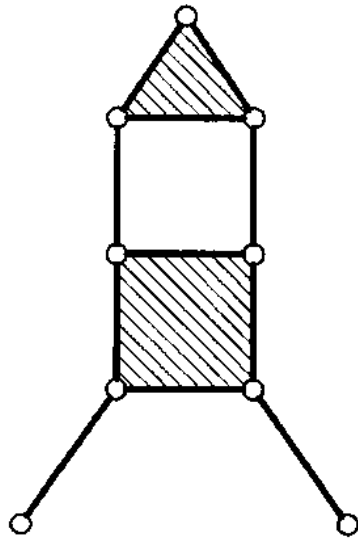

6GA6

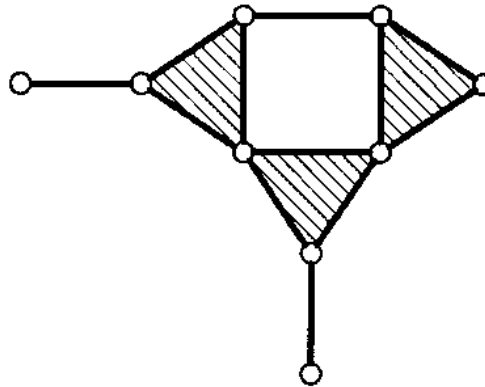

6GA7

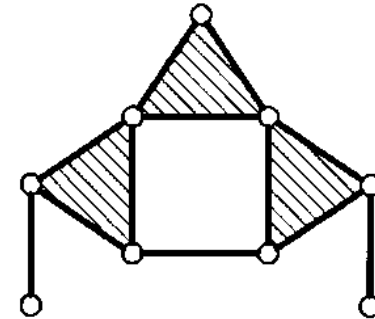

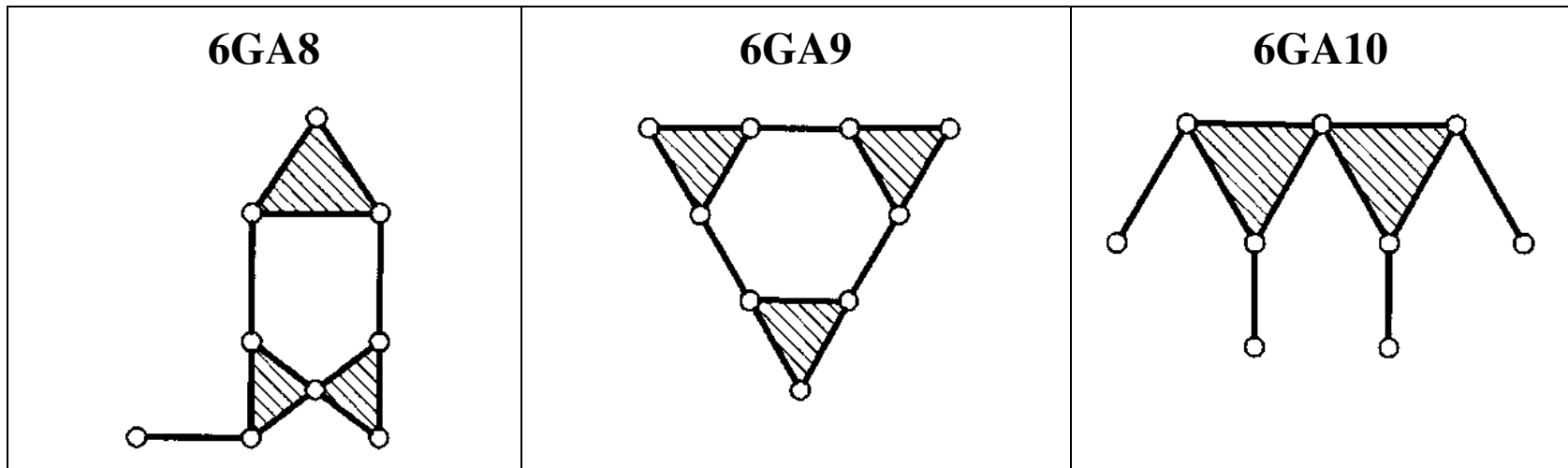

Grupos de Assur de seis eslabones

О группах Ассура, фермах Баранова, цепях Грюблера, плоских шарнирных механизмах и об их структурном синтезе
 апрель 2007 Э.Е. Пейсах

<http://technomag.edu.ru/doc/65274.html>