

7 July 2013

**Dr Eng. Jan Pająk**

**”Web pages of Jan Pająk - [free energy.pdf](#)”**

**(i.e. a brochure with text of the web page named [free energy.htm](#)  
entitled “Free energy generators: principles and operational prototypes”)**

Wellington, New Zealand, 2013,

ISBN 978-1-877458-69-9.

Copyright © 2013 by Dr Eng. Jan Pająk.

All rights reserved. No part of this brochure may be reproduced, stored in a database or retrieval system, transmitted, or distributed in any form or by any means, electronic, mechanical, photocopying, recording, or otherwise, without the prior written permission from the author or a person legally authorized to act on his behalf. From the obligation of getting such a written permission are only released those who would like to prepare a single copy of this monograph for their personal use oriented towards the increase of their knowledge and who fulfil the condition that they will not use the copy prepared for any professional purpose or for accomplishing material gains, and also that they copy the entire brochure - including the title page, all items, all illustrations, and all enclosures.

Date of the latest update of the web page presented in this brochure is provided above in the top-left corner. (Note that in case of having access to several copies of this brochure, it is recommended to read the copy which has the latest date of amendment.)

This brochure publishes the text of the web page authored by Dr Eng. Jan Pająk, indicated in the title of it. In turn the author's web pages are forms of fast reporting to the readers results of scientific research accomplished by the author of this brochure. The author is aware, that this research, and the results, are unique, as no-one in the entire world undertook earlier research of topics elaborated in this brochure. Therefore ideas which this brochure presents are the intellectual property of the author of this brochure. All ideas, theories, inventions, discoveries, explanations, descriptions, etc., published here, which have documentary or evidential value, are presented accordingly to standards applicable for scientific publications (reports). A special attention the author has given to the requirement of repetitiveness, i.e. that on the basis of this brochure any professional scientist or hobby investigator who would like to verify, repeat, or extend the author's research should be able to recreate his work and arrive at the same or very similar results and conclusions.

This brochure is on the subject connected with the most important monograph by the author, which [\[1/5\]](#) edition has the following editorial details:

Pająk J.: "Advanced Magnetic Devices", Monograph, Wellington, New Zealand, 2012, ISBN 978-1-877458-01-9, in 18 volumes;

Contact addresses to the author valid in 2013 – i.e. during the preparation of this brochure:

**[Dr inż. Jan Pająk](#)**

P.O. Box 33250, Petone 5046, NEW ZEALAND

Email: [janpajak@gmail.com](mailto:janpajak@gmail.com)

Welcome to this web page on already operational prototypes of extraordinary "free energy generators". These devices generate technically useful energy without consuming any fuel or any other form of energy. So they can turn extremely important to our energy-starved civilisation. The operation of these generators is exploiting a phenomena of physics which are still unknown to our present official science - for example a phenomenon which represents a "reversal of friction" (i.e. similarly like "friction" spontaneously converts motion into heat, this "reversal of friction" spontaneously converts heat into motion). In spite that such devices sounds extremely unusual, actually several working prototypes was already build by devoted hobbyists and was proven in operation. A primitive version of one of these devices, i.e. the "telekinetic cell", was even manufactured, after being embedded into components of so-called "crystal radio" - which was the only appliance on Earth that worked perfectly without any energy supply. Descriptions of these working prototypes are to follow. Now is the right time to investigate these devices scientifically in order to prepare

them to mass production. Our civilisation desperately needs them.

---

## Part A: Introductory information of this web page:

### #A1. What are goals of this web page:

There are numerous goals which I would like to accomplish via publishing this web page. The main goal is to indicate examples of working prototypes of free energy generators to these investigators who intend to build or research such devices. In this way I hope to encourage these investigators to continue their efforts towards overcoming obstacles placed on their paths by the curse of inventors (described in item #H1 on this web page), and completing these urgently needed generators of free energy on the Earth.

Another goal is to explain the design, operation, specification, technical problems, and new potentials which are linked to the generators of free energy described here. In this way the page is to keep well informed these investigators who decide to contribute their own effort towards constructing perfectly working prototypes of these revolutionary devices, and in this way who attempt to lift the civilisation level of humanity.

Additional goal of this web page is to disclose and describe the curse of inventors which persecutes creators of new technologies on the Earth (this curse is described in item #H1 below). In turn through the describing and explaining this secretive persecution of creators of new technologies on the Earth, I hope to indirectly help inventors and creative researchers, whom the curse of inventors also disallow to accomplish their own goals which could lift the civilisation level of the humanity.

### #A2. The philosophy of totalizm reveals, that also in the matter of "perpetual motion" our scientists are mistaken:

The official human science is famous from chronic committing cardinal errors and from continuous need to deny of whatever it was claiming earlier. There is several reasons for such erroneousness of this science. The most important one amongst these has the philosophical nature and boils down to a single-side view of the surrounding reality by the official science. Namely, **our official science everything approaches from the stand which by [philosophers is called "a posteriori" - means "from effects to a cause"**. in this one-sided approach the science behaves like a tourist which looks at a new city or country just from a comfortable arm chair sitting on a balcony of the hotel in which he temporally lives - as I am explaining this more comprehensively e.g. in item #C1 of my web page named telekinetics.htm and in item #A2.6 of a different web page named

[totalizm.htm](#). (Not without a reason so-called "normal people" insolently describe the present professional scientists that they supposedly live on the **ivory towers** - which describing seems to also be supported by analyses from item #I1 of the web page named [god exists.htm](#) as well as from items #C2 to #C4 of the web page named [telekinetics.htm](#).) In turn from the everyday life we know jolly well, that if one really wants to get to know something, then he must examine it thoroughly from at least two different points of view, e.g. in case of getting to know a new city or country, one needs to go far from a luxury hotel and see how it looks like "from behind" - while even better if one starts to live and work in it for several successive years. In other words, independently from that "a posteriori" approach to research practiced by the old official science, **it is necessary to research the surrounding reality also from a completely opposite approach, by the philosophers called "a priori" - means "from causes to effects"**. This opposite approach is already practiced by the new and "competitive" towards the old official one, still unofficial science called the **"totaliztic science"** (descriptions of which the reader also may find in items #C1 and #A2.6 from the abovementioned my web pages). Another reason for which the official science continually is at error and commits "cardinal mistakes" is that, as so far, it maintains an "absolute monopole for knowledge", and thus NO-ONE verifies statements of this science - because so-far it has no official "competition". (But currently such a "competition" gradually emerges in the form of this new unofficial "totaliztic science" that I already mentioned above.)

As this is revealed to us by the [philosophy of totalizm](#), one amongst such matters about which the official human science for sure is mistaken, is the possibility to build the so-called "perpetual motion". So-far the official human science categorically announces that supposedly a "perpetual motion cannot be build" because the principle of operation of it would run against so-called "laws of thermodynamics". However, the **theory of everything** called the [Concept of Dipolar Gravity](#) (from which the philosophy of totalizm originates), proves to us logically that **devices called "perpetual motion" are just versions of present "windmills" in which for "winds" which propel these devices are used phenomena which "blows" continually for thousands (or even millions) of years with always the same force**. In other words, a "perpetual motion" can be build immediately after the humanity fulfils two following conditions, namely (1) someone discovers a kind of "wind" which would "blow" continually and with the same force e.g. for millions of years, and (2) an inventor finds a principle of converting "blows" of such a "wind" into some noticeable manifestation - e.g. into a motion or propelling energy. As it turns out, the condition (1) is already fulfilled a long ago. After all, the present science knows a number of natural phenomena which represent kinds of "winds" that "blow" continually for millions of years. Examples of such "winds" include: the rotation of our planet Earth, the motion of Moon around the Earth, the magnetic field of the Earth, waves of a "cosmic noise", temperature difference between surface of the Earth and e.g. the absolute zero of cosmic space or coolness of upper atmosphere, various behaviours of elementary particles, the reversal of friction (i.e. "telekinesis"), and many more. Thus, the only step that is left in order to really introduce "perpetual motion" to everyday life, is to work out a principle of operation with the use of which from one amongst these continual "winds" can be retried a form of motion or useful energy. Because human inventive capabilities do NOT know limits, the working out and implementation of such a principle is just only a matter of time.

Several principles of operation which convert such "infinitely blowing winds" into a motion or useful form of energy are already described on totaliztic web pages. Examples of these are all principles used in devices from this web page, and also principles described on web pages named [fe cell.htm](#), [boiler.htm](#), [telekinetics.htm](#), [eco cars.htm](#), and in item #G2 from the web page [pajak jan uk.htm](#). Thus, in spite that with the active effort of immoral people the so-called "curse of inventors" (described in item #H1 of this web page) still obstructs the industrial implementation of these principles of operation, unavoidably approaches the time when some form of the "perpetual motion" becomes constructed by someone and implemented in the real life, while the official human science will again be

forced to jump under a table and publicly retract ("bark out") whatever it previously claimed on this subject.

An illustrative explanation how a "windmill" propelled by invisible and still unknown to our science "wind" would be taken for the "perpetual motion" and thus persecuted by present scientists, is also presented in item #A2 of the separate web page [oscillatory chamber.htm](#).

## #A3. What motivated me to prepare this web page:

**Motto: The philosophy of [totalizm](#) teaches, that our physical world was intentionally created in such a manner, that *'everything that humans can think of, humans can also accomplish'* - only that someone must firstly find a manner how to implement a given idea." (See subsection #15.4.2 from volume 5 of [monograph \[1/5\]](#).)**

The reader probably saw in a television an advertisement of so-called "heat pumps". In order to be understandable to an ordinary bread eater, and simultaneously to appeal to the wallet of the viewer, these advertisements usually state that e.g. if you spend 1 dollar for electricity which propels such a "heat pump", then this heat pump fills up your flat with the heat worth (let say) 3 dollars. If someone translate this advertisement onto a technical language, then it actually states that the energy efficiency of these heat pumps exceeds 100%. This means that such heat pumps generate much more thermal energy than the amount of electrical energy they consume. Of course, since it is possible to build technical devices which for any reasons generate much more energy than the amount of energy consumed to sustain their operation, then immediately an idea comes to the mind, to redirect into a feedback loop a part of the excess of energy that they generate, and supply their own operation with this looped energy. The outcome of such looping of energy would be that we would obtain a "generator of free energy". After all, such a generator would supply itself into the energy that it requires for sustaining its own operation. Simultaneously an excess of the energy that it generates would be released for a consumption. This excess would be gained completely "for free" (hence the name "free energy").

Thus the idea of "generators of free energy" is very simple. Also, as we see it from the over 100% efficiency of "heat pumps", this idea is actually technically feasible. Only that in order it is implemented practically, we firstly need to overcome several barriers. The most important amongst these "barriers to overcome" is a psychological barrier. As almost everyone knows, the official human science implanted a view to every person on the Earth, that devices in past called "perpetual motion" never can be build - because their principle of operation supposedly runs against laws of the physical world. In turn the name "perpetual motion" is simply an old Latin name for the most vital component of present "generators of free energy". This prejudice towards generators of free energy, officially imprinted in minds of all people, is extremely destructive. It discourages psychologically the majority of potential researchers to even consider building such devices. Thus these researchers never are going to think how to overcome next barriers which holds back the building of these devices, such as the barrier of lack of knowledge of their principles of operation, or the barrier of actual technical implementation of these devices.

Fortunately for the humanity, there were some courageous hobbyists, who realised that since the official human science chronically is at wrong with practically all possible matters, probably it is also at wrong in the matter of impossibility of building perpetual motion

devices. Thus, these more courageous amongst them undertook the building of such devices or undertook their theoretical research. Thanks to these few courageous people, we already have on the Earth first working prototypes of these devices - in spite that the official human science still claims that supposedly these devices cannot be build. However, contrary to the actual existence of these working prototypes, the official science still stubbornly denies the possibility that they can be build. This creates quite a paradox situation on the Earth. On one hand such devices already do exist, but on the other hand it is officially claimed that these devices do NOT exist. The situation resembles me the situation with many other important matters that are officially denied by the human science, such as UFOs, ghosts, souls, God, another world, etc., etc. Of course, this official claiming that free energy generators do NOT exist and cannot be build is highly destructive. After all, it blocks the technical progress of humanity. So in order to assist in the breaking through the impasse caused by such a situation, I decided to publish this web page. My motivation for the publishing it provided the actual existence of first working prototypes of free energy generators.

According to my understanding, the reason for which the official human science still stubbornly denies the existence and possibility of building these devices, is taking by the science the lack of serial production of these devices in factories, for the impossibility of building them. However, true reasons for which these devices are NOT produced in factories so-far, do NOT mean that these devices cannot be build at all. Frequently these true reasons include, amongst others, either (1) bureaucratic obstacles (as this is the case with the "telekinetic heater" described in part #E of this web page), or (2) their too small, as so-far, energy effectiveness which does NOT justifies their practical utilisation (as this is the case with the "perpetually rotating flywheel" described in part #F of this web page), or (3) practical incompatibility of their energy output to present energy requirements (as this is the case with the "telekinetic influenzmaschine" described in part #D of this web page). In other words, for naive people the official science still gets away with the lies that these devices CANNOT be build, only because as so-far these devices for various reasons cannot be seen in every shop or in every house. However, although just in places which for general public are difficult to access, first working prototypes of these devices already do exist. I hope, that through publishing this web page, and through indicating here where or how prototypes of these extraordinary devices can be seen with one's own eyes, I could assist for a growing number of people to understand that first working prototypes of these generators in fact do exist and in fact already work. Only that these prototypes still require further research, development, and improvements, before we are able to manufacture them in factories and purchase them in shops.

---

## Part #B: Theoretical foundations of the generators of free energy:

### #B1. What is this "free energy":

The name "free energy" already established itself on our planet for an entire class of working devices. These devices can be defined in the following manner: **"free energy devices are generators of energy or mechanical motion which are supplied into energy by some phenomenon which still remains unknown to the humanity (e.g. by some invisible "wind" described in item #A2 above), and thus which make**

**impressions that their energy efficiency exceeds 100% ".** An example of such devices can be generators of energy the operation of which is based on the physical phenomenon that represents a **reversal of friction**. Sometimes the name "free energy" is also used for describing general principles on which these devices generate energy (means they generate energy literally "for free"). Due to the employment of e.g. the reversal of friction, devices that generate free energy actually cause the spontaneous conversion of thermal energy contained in the environment into motion of selected objects (e.g. into motion of electrons in a wire). The main goal adopted by developers of these devices, is to work out such an operation of free energy generators, that they generate energy without actual consuming any fuel, or any other form of external energy supplied to them by users. So these devices generate energy literally at zero cost - means for free.

The misunderstanding of operation of these devices by current orthodox science, induced a kind of condemnation atmosphere that prevails amongst present scientists. This atmosphere claims that free energy devices supposedly are not going to work, and that their operation supposedly breaks the Energy Conservation Principle plus few other laws of thermodynamics. However, as it turns out, these devices are already working - an example of one that works perfectly is shown on the first photograph "Fig. #B1" from this web page (i.e. on Figure LA4 from [monograph \[1/5\]](#)). Also, they do not break any law of thermodynamics at all, because their operation utilises the phenomenon which represents a reversal of friction.

## **#B1.2. Definitions of terminology: "generators of free energy", "perpetual motion", "renewable energy devices":**

Let us define now what in fact we understand on this web page by this extraordinary energy devices which generate energy without consuming any fuel nor requiring technical supply into energy.

Let us start from defining devices called here **generators of free energy**. *Generators of free energy are technical devices which as a whole generate practically useful excess of energy of a useable form, without consuming for this any fuel nor requiring any external supply in energy.* As such, generators of free energy are characterised by several unique attributes, for example: (1) *they are supplied into energy by some phenomenon which still remains unknown to the humanity (e.g. by some invisible "wind" described in item #A2 above), thus they make an impression that their energy efficiency exceeds 100% - means that they generate much more energy than the energy required to propel them (see also item #B1 on the totaliztic web page named [boiler.htm](#)), (2) they have build-in the "energy feedback loop" which redirects a part of the energy that they generate for self-supplying their own propulsion - thus they do not require any external energy or fuel supply, (3) their energy yield is sufficient for justifying their utilisation as generators of energy, (4) the form of energy they generate allows for a practical utilisation of this energy, etc., etc.* Because of these unique attributes, the construction of generators of free energy is indescribably important for the future of our civilisation. After all, this construction is going to solve all present energy problems of humanity. In spite of this, inventors who work on the development of these extraordinary devices, are viciously persecuted - amongst others with the aid of this "curse of inventors" described in "part #H" of this web page. A curious thing is that the biggest enemies of the builders of these extraordinary generators are present scientists - means people who are paid by the society

to promote progress. Also the fact that the official science was forced already hundreds of times by the real life to overturn its own previous claims, and also the fact that the first such generators of free energy are already operational on the Earth, does NOT seem to hold back many present scientists from the escalation of destruction through erroneous telling the society that such devices cannot be build.

At this point it is worth to add, that there is only a small difference between "generators of free energy" and devices which in past were called with the Latin name **perpetual motion**. Namely, generators of free energy generate practically useful amounts of some form of energy. As such, they are technically useful for the society. Examples of "free energy generators" described on this web page include the "telekinetic cells", "telekinetic influenzzmaschinen", and "telekinetic heaters". In turn "perpetual motion" devices generate enough energy to enable them to continue forever some form of visually noticeable motion. But the amount of energy which these "perpetual motion" devices generate in many cases can be too small to make them useful in practice. Examples of such perpetual motion devices include the "perpetually rotating flywheel" described in "part #F" of this web page, and also the so-called "PMM" (i.e. "permanent magnet motor") described in subsection LA2.1 from volume 10 of [monograph \[1/5\]](#).

From the technical point of view, the difference between "free energy generators" and "perpetual motion devices" boils down to (1) the use of a phenomenon in their principles of operation, which allows to form an "energy feedback loop" (e.g. the use of technically induced telekinesis), and (2) building-in this "energy feedback loop" into given free energy generators so that a part of energy excess which these generators provide at the exit, is looped back to the entrance in order to self-propel them. Devices which do NOT have such an "energy feedback loop", such as the "perpetual motion flywheel" described in part #F of this web page, can only fulfil the function of a "perpetual motion". In turn devices which have such an "energy feedback loop" build into them, such as the "telekinetic cell" described in part #C of this web page, are able to work as generators of free energy.

Generators of free energy described on this web page, as well as perpetual motion devices, need to be distinguished from devices for intercepting and transformations of so-called "renewable energy". The difference between them depends on the continuity and reliability of the generation of energy. Namely the generators of free energy and perpetual motion devices are reliable and indestructible, means they work always and forever. Also always and forever they generate their energy or motion, unless someone or something purposely switches them off, or puts them out of order. Their example can be the "perpetual motion flywheel" described in part #F of this web page, which after is build, will work reliably and continually practically forever, or until someone or something destroys them. On the other hand, devices for the intercepting and transformations of "renewable energy" are unreliable and work only when they receive a supply of the required form of energy. An example of these can be a windmill, which generates energy only when a wind blows with the required force. An interesting paradox which hits our eyes, is that the official human science recognises the existence and the operation of devices capable to intercept such renewable energy, but the same science denies and contradicts the possibility that there is possible to build reliable and infinitively working perpetual motion devices and generators of free energy.

## **#B2. Telekinesis - means the reversal of friction:**

**Motto: "The philosophy of [totalizm](#) teaches that 'every phenomenon must**



## ***have its counter-phenomenon'."***

In 1924 the great French physicist, Louis DeBroglie, published his important discovery, which is sometimes called the "principle of the symmetry of nature". According to this principle, in our universe everything is strikingly symmetrical in many ways. DeBroglie's symmetry principle provided philosophical and scientific foundations, which allow us to understand a number of natural phenomena, thus opening them for explorations, discoveries, formulation of new theories, completion of new devices, etc. For example: the Periodic Table of the Elements (also called the Mendeléev Table), the existence of a mirror duplicate for each elementary particle (e.g. electrons and positrons, protons and antiprotons), and the similarities between atoms and solar systems - all these document the symmetry existing in the structure of matter. The similarities between equations that describe different physical phenomena (e.g. Navier-Stock's equation describing flow of fluids and Laplace's equation describing heat transfer) express symmetry in the laws of nature. In turn the technological correspondence between e.g. pumps and hydraulic motors, or electricity generators and electric motors, reflect the symmetry in the operation of technical devices.

One of the vital implications of the DeBroglie's symmetry, which has a direct bearing on the creation of free energy generators, is the postulate that **"every phenomenon must have a corresponding counter-phenomenon"**. So far a large number of phenomena and corresponding counter-phenomena has already been discovered, which confirm the correctness of this postulate. For example, the existence of electrical luminescence utilized in fluorescent bulbs and in various light-emitting diodes to transform electricity into light, has a counter-phenomenon in the form of the photoelectric effect that in photocells and solar panels transforms light into electricity. The so-called "left-hand rule", also called the "motor effect", which describes phenomena used for the transformation of electricity into motion, has its counter-rule in the form of "Fleming's right-hand rule", also called the "generator effect", which works in reverse, i.e. it transforms motion into electricity. The Seebeck Effect, which produces a flow of electrons through a junction of two dissimilar conductors being heated, has its counter-phenomenon in the form of the Peltier Effect, which causes the heating and cooling of materials in a similar junction when a current is flowed through it. The piezoelectric effect, which converts the deformation of a crystal into electricity, and which is utilised e.g. in piezoelectric lighters to produce an igniting spark, has its counter-partner in a phenomenon which also is called "piezoelectric effect", although it works in a reversed manner - i.e. it converts the electric impulse into a deformation of a crystal (this counter-phenomenon is utilised for example in piezoelectric vibration generators).

However, contemporary orthodox physicists claim that there is an exception to this postulate. They indicate friction to be this exception. According to all to-date claims of orthodox scientists, friction is considered to be the irreversible phenomenon, which has no counter-phenomenon. But in 1985, due to the formulation of a new scientific theory which I named the **Concept of Dipolar Gravity**, I was granted the privilege of discovering the phenomenon which represents an exact reversal of friction. Because in the natural form this phenomenon is manifested during telekinetic (or psychokinetic) motion, I named it the **"Telekinetic Effect"**. **In the same way as friction spontaneously converts motion into heat, the Telekinetic Effect spontaneously converts heat into motion**. Not long after the Telekinetic Effect was discovered, I also managed to found technical ways of releasing it (through an acceleration or deceleration of magnetic field force lines).

The discovery, that **the Telekinetic Effect represents a reversal of friction**, and a subsequent discovery of the technological ways of activating this effect, provide the theoretical foundation for building various free energy devices. The reason for this is, that according to the mechanism of the effect discussed here, all what is required in order to generate such free electricity, is to subject a section of an electric wire to the action of such an effect. In the result, all free electrons that are contained in such a wire, are going to be put into the telekinetic motion from one end of the wire to the other end. In turn such a mass

relocation of electrons in a wire, is nothing else but a flow of electric current. The thermal energy that sustains this flow originates from the environment, from which it is spontaneously extracted by the mechanism of the reversal of friction. The Telekinetic Effect is spontaneously extracting this energy from the environment just on its own. So this energy does not need to be supplied to the device which generates the free electricity (i.e. hence the expression "free energy").

## #B3. Evidence for the existence of the reversal of friction:

Since free energy devices utilise the reversal of friction which so-far remained unknown to orthodox scientists, the reader may wonder whether we have any evidence that this phenomenon does exist at all. As it turns out, we have plenty of such evidence. Actually entire subsection H1.2 from volume 4 of [monograph \[1/5\]](#) is devoted to description of this evidence. The most widely known type of it are folklore observations that supernatural kinetic phenomena always cause rapid temperature drops in rooms in which they are observed. These temperature drops are in fact outcomes of the conversion of thermal energy contained in the air from these rooms into some form of supernatural motion. (Notice that the old expression "supernatural", in modern terminology from this web site actually means "utilising principles of telekinesis".) Other evidence stems from the observation of operational free energy devices that already exist and work. All these devices always decrease the environmental temperature while generating free energy. But the most objective proof for the existence of the reversal of friction is the so-called "extraction glow" shown on the last photograph from this web page. This glow is actually emitted because atoms rapidly loose their thermal energy - for the detailed description of this extraction glow see subsection H6.1.2 from volume 4 of [monograph \[1/5\]](#).

## #B4. Perpetual motion = historic sightings of free energy devices:

Although the construction of operational free energy devices is only possible after people mastered technical release of the reversal of friction, someone kept showing such devices to selected people since ancient times. These historic witnesses of such devices used to call them "perpetum mobile", or "perpetual motion" machines. Unfortunately, the operation of these devices cannot be based on the phenomena of our physical world. (They utilise phenomena of the counter-world.) Thus orthodox scientists coined an erroneous myth, stating that supposedly it is impossible to build them at all. But the life (and inventions described here) proved this myth to be wrong.

(**Note** that you can see the **enlargement** of each photograph from this web site, simply by **clicking** on this photograph. Most of the Internet browsers that you may use, including the popular "Internet Explorer", allow also to **download** each illustration to your own computer, and then look at it, reduce or enlarge the size of it, or print it, with your own graphical software.)

\* \* \*

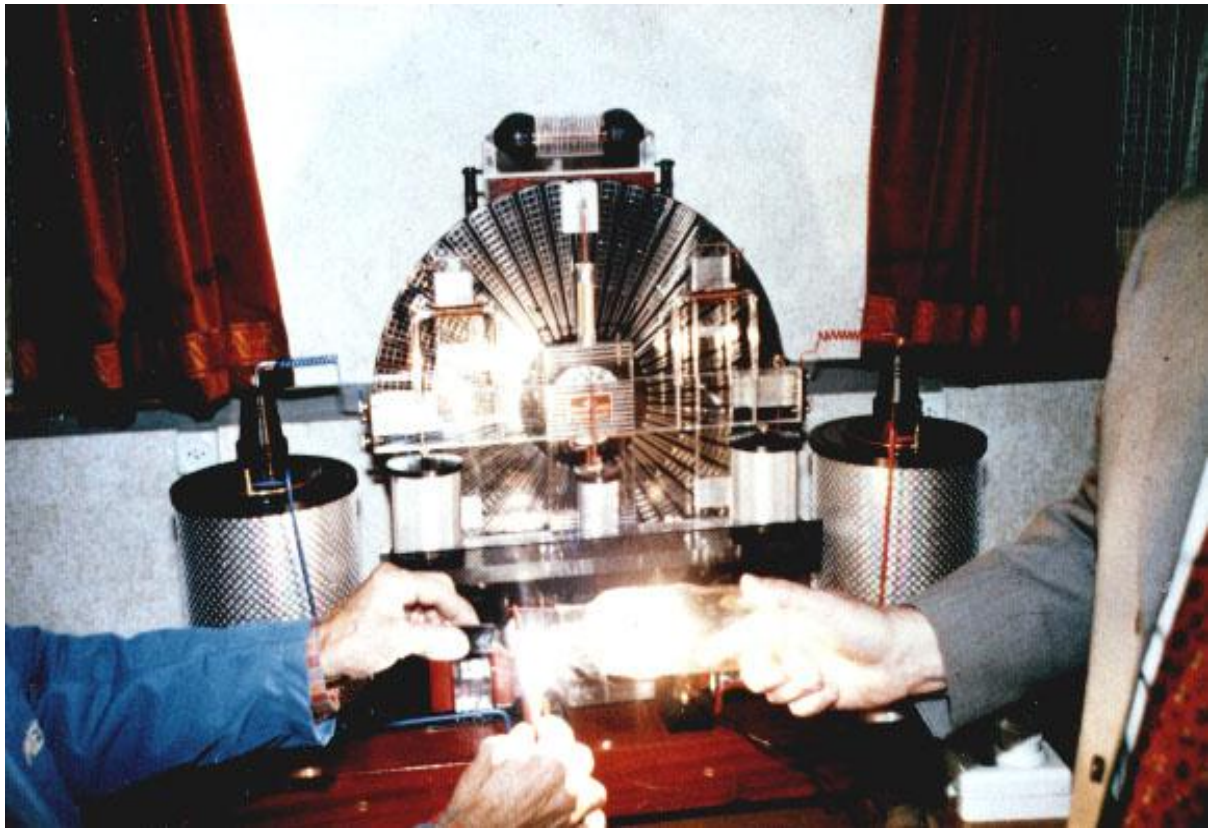

**Fig. #B1: "Thesta-Distatica", means a two-disk "telekinetic influenzmaschine". It is the most advanced free energy device which was build on Earth so-far, and which actually works producing abundance of free energy. A relatively full description of this device is presented in item #D1 of this web page. Please notice that Methernitha has also two smaller such devices working on the same principle, which use a single disk and which are called "Testatica". (The above photograph originates from [monograph \[1/5\]](#) where it is shown on "Fig. LA4".)**

\* \* \*

The free energy device from "Fig. #B1" above (i.e. Figure LA4 from [1/5]) is called **Thesta-Distatica**. It belongs to general category of so-called "telekinetic influenzmaschinen". The word "influenzmaschinen" originates from the German language. It designates a whole class of machines, which utilise the phenomenon of electrostatic induction in their operation. This phenomenon is called "influenz" in German. (One needs to distinguish between the phenomenon of "influenz", and other phenomena that also can be utilised in various electrostatic machines. For example the Van de Graaff Generator utilises the phenomenon of "friction".) Historic examples of influenzmaschinen include the **Töpler** machine with a single disk, or the **Wimshurst** electrostatic machine with two disks. In turn "telekinetic influenzmaschinen" are more advanced versions of influenzmaschinen, which for their operation utilize additionally the phenomenon called the Telekinetic Effect. (Means they utilize telekinesis in addition to effects of electrostatic influence.)

Principles of operation and design of telekinetic influenzmaschinen are described in details in subsection LA2.3 from volume 10 of [monograph \[1/5\]](#). These principles are also briefly summarised here, in the further part of this web page. The telekinetic influenzmaschine "Thesta Distatica" shown above was build by the Swiss Religious Community calling itself the **Methernitha**. The Thesta-Distatica generates around 3 kW AC 50 Hz electrical energy at around 600 Volt. From the operational point of view, it is actually an AC motor operating on principles of electrostatic influence. This motor runs because free electrical energy is supplied into it by a "telekinetic cell" that is embedded into its design (the design and operation of such a telekinetic cell is summarised in item #C1 of this web

page, while discussed in more details on a separate web page about [telekinetic cells](#)). The first two such telekinetic influenzmaschinen called "Testatica" (with single disks, based on principles of the Töpler machine) were build not to produce free electricity, but to produce free mechanical motion. The goal of their construction was to illustrate visually to highly sceptical people and to orthodox scientists, that because these machines can produce physical motion without any form of energy supply, they actually prove that the building of **perpetual motion** machines (also called "perpetum mobile") is really possible.

## #B5. The Concept of Dipolar Gravity:

Before I proceed with an explanation how this **Telekinetic Effect** (means the "reversal of friction") works and is utilised for the generation of free electricity, I firstly need to introduce briefly a new scientific theory, which explains principles of telekinesis and telekinetic motion. (It also explains numerous other previously "mysterious" phenomena, e.g. telepathy, the operation of time, energy, magnetic field, and many more.) This new theory is called the Concept of Dipolar Gravity. The **Concept of Dipolar Gravity** is an extremely interesting scientific theory, which I would highly recommend for reading. It turns out to be this special **Theory of Everything** searched by people for so long. For example, it explains telekinesis and mechanism involved in telekinetic motion. It explains the phenomenon of telepathy. (Telepathy is discussed on a separate web site, namely on [telepathy.htm - about telepathy and telepathic communication devices](#).) The Concept of Dipolar Gravity explains also what is this "second world" called the "counter-world", to which we are shifting after our death. It reveals where this second world is located. It explains the nature of this counter-world. After all, it is this second world where every telekinetic motion is initialised and carried out. It discloses how our soul and spirit work and look like. It allows to deduce what we feel at the moment of death and during this shifting to another world. It explains what is nirvana, how our feelings work, what is memory and how memory works, and many more. (Actually all these topics which stem from the Concept of Dipolar Gravity are briefly addressed on appropriate web pages listed in the "[Menu 4](#)", which I recommend to visit.)

Descriptions of the "Concept of Dipolar Gravity" are provided in all my vital monographs, starting from volumes 4 and 5 of my newest [monograph \[1/5\]](#) entitled "Advanced Magnetic Devices", and finishing with volumes 6 and 7 of my almost oldest [monograph \[8\]](#) entitled "Totalizm". Both these publications, means [monograph \[1/5\]](#) and [monograph \[8\]](#), as well as all other my monographs, are available free of charge via this web page. Because it does not take a lot of time to review these two volumes, while they open our eyes on many phenomena which previously remained unexplained, including principles of operation of "free energy devices", I am inviting you to have a look at them.

Those readers who have no time to read detailed [monograph \[1/5\]](#), may also find in Internet a summary of the description of the "Concept of Dipolar Gravity". For example, this concept is quite well presented on the web page [dipolar gravity.htm](#).)

## #B6. Technical release of the "Telekinetic Effect":

The Concept of Dipolar Gravity explains comprehensively the Telekinetic Effect. One of vital details that it tells us, is the principle utilised for triggering this effect technically. As it

turns out, **in order to release the Telekinetic Effect technically, it is enough to accelerate or to decelerate magnetic field force lines.** All movable objects, that are wrapped into such accelerated or decelerated force lines, are experiencing action of the Telekinetic Effect. Means that the phenomenon representing the "reversal of friction" is actually starting to act upon them. In turn this reversal of friction causes the spontaneous absorption of thermal energy from the environment, and conversion of this thermal energy into motion of objects subjected to the Telekinetic Effect. So if such accelerated magnetic field wraps for example electrons inside of a wire of conductor, the result is that these electrons start to rapidly move at the expense of thermal energy from their environment. In turn such a rapid motion of large quantities of electrons forms electric current. Thus the technical release of the Telekinetic Effect allows for a relatively easy generation of free electricity.

## **#B7. Principles required to generate free energy:**

Since the Concept of Dipolar Gravity explained to us how to release the Telekinetic Effect technically, this also tells us what general principle must be used to generate free electricity. So, as it turns out, every device for generation of free electricity must have build into it some manner of accelerating or decelerating force lines of magnetic field which are wrapping electrons contained in conductive wires. In turn these accelerated or decelerated force lines trigger the release of the Telekinetic Effect that acts upon these electrons. The result is that the Telekinetic Effect, acting as the reversal of friction, spontaneously extracts thermal energy from the environment that surrounds given wires, and transforms this thermal energy into motion of electrons inside of the wire. This motion in turn manifests itself as a flow of free electricity. Such free electricity can be then used for supplying any electric appliances, in a similar manner as electricity generated by our current energy generators is. The only side effect of such electricity generated by free energy devices is, that it pulsates in a manner which tends to release a residual Telekinetic Effect. Therefore near such free energy devices various **supernatural phenomena** are going to take place, which are not present around devices supplied with electricity generated in a conventional manner.

---

## **Part #C: Telekinetic cells (also called telekinetic batteries):**

### **#C1. The telekinetic cell - the simplest free energy device:**

In 1989 I had the honour of inventing a free energy device, which I called then the "telekinetic cell" or the "telekinetic battery". This my theoretical invention stemmed from the research on the Telekinetic Effect that I completed earlier. I described my invention

quite well in numerous publications, including my oldest [monograph \[6\]](#) and newest [monographs \[1/5\]](#) available through this web site. Thus readers are able to get a good understanding of the operation of this device, simply by reading my publications. As I later discovered with an enormous shock, just such telekinetic batteries that I invented earlier and described in my publications, are already embedded as main components in practically all operational free energy devices in existence on Earth. I could recognise them easily, because I actually invented them. So I am able to identify which parts of a given free energy devices are components of the telekinetic cell supplying a given device with free electricity, in spite that these components of the telekinetic cell are embedded into the design of a given device, and thus they normally are undistinguishable from the device itself.

Telekinetic batteries of my invention are very simple devices, which generate free electricity without containing any moving parts. They can operate both, as stand alone generators of free electricity, or they may become components of other devices, supplying them with free electrical energy required for their operation. For example, the energy required for running the "Thesta-Distatica" shown above in the first "Fig. #B1" (see LA4 from [1/5]) of this web page, actually originates from a telekinetic cell. Also the "telepathic pyramid" shown on "Fig. #C1" to the right (see Figure K1 from [1/5]) is supplied into electricity just by such a telekinetic cell. Therefore, in order to understand the operation of all free energy devices, we need to start from learning the operation of telekinetic cells of my invention.

Notice that there is also a separate web page which is entirely devoted to the presentation of the design and operation of the telekinetic cell of my invention. This web page can be run from "Menu 1" and "Menu 2" via the name [telekinetic cell](#).

## #C2. Components of a telekinetic cell:

A simple telekinetic cell is shown on "Fig. #C1" (i.e. on the upper part of Figure K1 from [monograph \[1/5\]](#)) - see it to the right from here. The interior and components of this telekinetic cell are illustrated in "Fig. #C2" (i.e. on the lower part of that Figure K1 from [1/5]). In turn their electrical connections are illustrated on the electrical diagram from "Fig. #C4" (i.e. Figure K3 from [1/5]). Here is the list of main components of this cell:

**1. Telekinetic inductors (I1) and (I2).** The most important component of every telekinetic cell are two inductors marked (I1) and (I2) on all my diagrams - including into this all diagrams from this web page, as well as diagrams from a separate web page on the [telekinetic cell](#) of my own invention. These inductors are components in which the telekinetic generation of free electricity is carried out. Both these inductors are composed of permanent magnets, onto which coils of conductors are wound up. In order to provide the generation of free electricity in both halves of sinusoidal cycles, two such inductors are needed, on which coils are wound in two opposite directions when related to the magnetic polarity of their permanent magnets.

The principle of electricity generation in these inductors is quite simple. Namely the magnetic field of permanent magnets on which these inductors are wound, changes the shape of (normally) sinusoidal curves of the electrical impulses which flow through these inductors. The result is, that instead of normally sinusoidal wave shape, this electricity starts to follow a shape that accelerates and decelerates electrons. In turn these accelerations and decelerations of electrons cause the release of the Telekinetic Effect (means the "reversal of friction") that acts on these electrons. The Telekinetic Effect spontaneously converts heat contained in the environment into a more powerful motion of electrons in wires. As the outcome, such inductors add small portions of energy to each electrical impulse that flows through them. Simultaneously they absorb heat from their environment.

(Means, while adding energy to the impulses that flow through them, they simultaneously cool their environment down.) So the Principle of Energy Conservation is fulfilled, while the free electrical energy is generated.

**2. Pulsar (Q).** The inductors described above do not generate their own electricity. They only telekinetically add the required power to weak electrical impulses which already flows through them, but which originate from other sources. Therefore, in order these inductors could work, they need to be supplied with a constant stream of electric impulses. For this reason, a second vital component of every telekinetic cell, is the so-called pulsar "Q". Such a pulsar is simply any device that supplies inductors I1 and I2 with an uniform stream of electric impulses.

In the telekinetic inflenzmaschinen shown above in "Fig. #B1" (i.e. LA4 from [1/5]) and described in item #D1 from the further part of this web page, a pulsar (Q) is simply a special electrode marked "ho", which hangs just above a spinning disk and in front of a permanent magnet, and thus which gathers uniform electrical impulses from this spinning disk. In turn in the "telekinetic cell" shown to the right in "Fig. #C1" (i.e. in Figure K1 from [1/5]), this pulsar is simply a quartz crystal (Q) that is made to vibrate uniformly by telepathic waves concentrated on it by the resonance cavity of a pyramid.

**3. Resonator (R).** Inductors of a telekinetic cell work by increasing slightly the amount of electric power that is contained in each single pulse of electricity which flows through them. But these small amounts of power need later to be added together in order to build up the energy output from such a cell. This dynamic adding together small increases of power is carried out by the component called the "resonator" and marked (R) on "Fig. #C4" (i.e. on Figure K3 from [1/5]). The resonator is simply an oscillatory circuit. It works in a cell similarly like a swing with a child, which to the energy already attached to the body of this child adds each single portion of energy that a parent contributes through repetitive pushing this child in the process of swinging.

**4. Reciprocator (T).** A next important component of every telekinetic cell, is a "reciprocator" (marked "T" on all diagrams from this web page and from monograph [1/5]). (In old times reciprocators were called "coherers".) If such a reciprocator is designed as a "tube" then it contains a mixture of ordinary kitchen salt with mercury, kept under vacuum.

The function of this "reciprocator" is quite a complex one. The detailed description of this function is provided in subsections K2.3 and LA2.3.3 from [monograph \[1/5\]](#). The most vital aspect of this function is also explained on a separate web page about the [telekinetic cell](#), where in order to describe it, an illustrative example of starting a stationary steam locomotive is used. But if we would like to summarise this function briefly, it is a bit similar to the function of a phase shift in position of both pistons from old steam locomotives, or a phase shift in pistons of modern car engines. (Unfortunately, no many people know that steam locomotives, in order to be able to start moving together with heavy wagons attached to them, must have at least two pistons, which work with appropriate mutual phase shifts of 90 degrees in their cycles of strokes.) Namely, this reciprocator prevents electrical **deadlocks** from occurring between oscillations of subsequent components of a given telekinetic cell. (As the reader probably knows, every oscillatory system has two points in its motion, which are called the "deadlock" points. For example, in engines these two points are when pistons stop motion in one direction and begin the motion in an opposite direction. When we have a situation, like in a telekinetic cell, that several separate oscillatory systems must cooperate with each other, these deadlock points hinder the cooperation - if they are not aligned with appropriate phase shift. In telekinetic cells this phase shift is produced by the "reciprocator".) Actually, without such a reciprocator, the telekinetic cell would not be able to start nor to work properly. Because the operation of reciprocators "T" is quite complex, I would advice to read about them from subsections LA2.3.3 and K2.3 of [monograph \[1/5\]](#), where they are described quite comprehensively and with all required details. A slightly more extensive than here description of reciprocators is also provided on the web page on [telekinetic cell](#) of my invention. When one sees this reciprocator "T" in action on any free energy device already build on Earth, it can be easily

recognised because it glows strongly. Namely the free energy which flows through it causes that it emits a powerful light. The first photo on this web page - see "Fig. #B1" above (or Figure LA4 from [1/5]) actually shows it glowing. In turn the "telekinetic battery" from "Fig. #C2" (or Figure K1 (low) from [1/5]) shows it in a non-glowing state (see the blue tube "T" visible by the basis of the "telepathic pyramid").

## **#C2.1. Notice that the same components of the "telepathic pyramid" simultaneously work as a telepathic transmitter and receiver (telepathyser):**

The device called "telepathic pyramid" which is described here in the function of a [telekinetic cell](#), actually performs two different functions. The cell is only the first one out of these two - after all, in order this device could work it must be somehow supplied with electricity. The second function of the same "telepathic pyramid" is the work as a telepathic transmitter and receiver, means as a so-called telepathyser. This second function, as well as the extraordinary history of this pyramid, are described on a separate web page [telepathy.htm](#).



**Fig. #C1: The above photograph shows me (i.e. [Dr Jan Pajak](#)) holding in hands a device called the "telepathic pyramid". A main component of such a telepathic pyramid is a telekinetic cell which supplies it with free electricity required for the operation.** (The above photograph originates from [monograph \[1/5\]](#) where it is shown in the upper part of Figure K1.) The detailed design and operation of this device is explained in subsection K2 from volume 9 of [monograph \[1/5\]](#). In turn the extraordinary history of this device, plus also details of its operation, are explained in [treatise \[7/2\]](#). Both these publications, i.e. [monograph](#)



[\[1/5\]](#) and [treatise \[7/2\]](#) are downloadable free of charge from this web site.

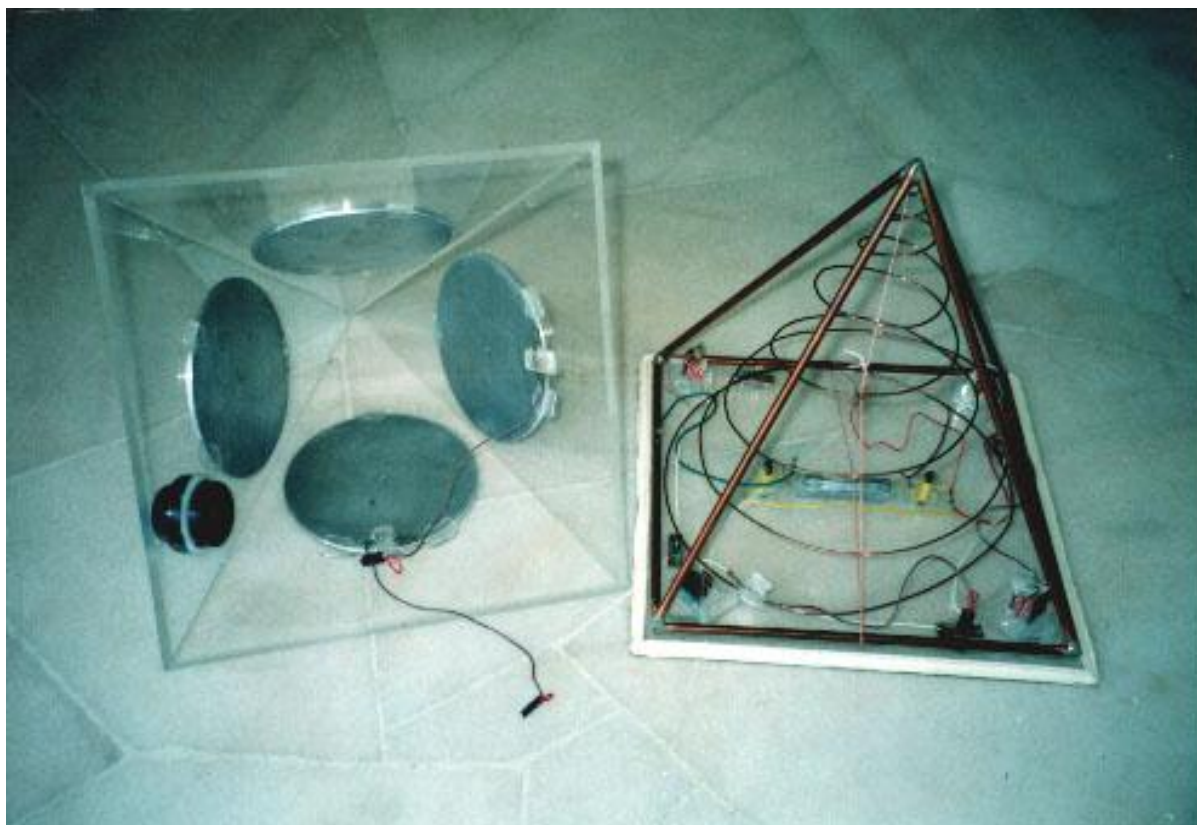

**Fig. #C2: The interior of the telepathic pyramid. This photograph illustrates major components of this device. Because each of these components is simultaneously a component of the telekinetic cell embedded into the telepathic pyramid in order to supply it with electricity, this photograph illustrates also main components of a telekinetic battery.** (The above photograph originates from [monograph \[1/5\]](#) where it is shown in the lower part of Figure K1.) The list of components shown on this photograph, as well as their operations, are explained in subsection K2.2 from volume 9 of [monograph \[1/5\]](#). They are also briefly summarised in item #C2 of this web page. In addition, there is a separate web page [fe\\_cell.htm](#) on the telekinetic cell, which describes each of these components in greater details.

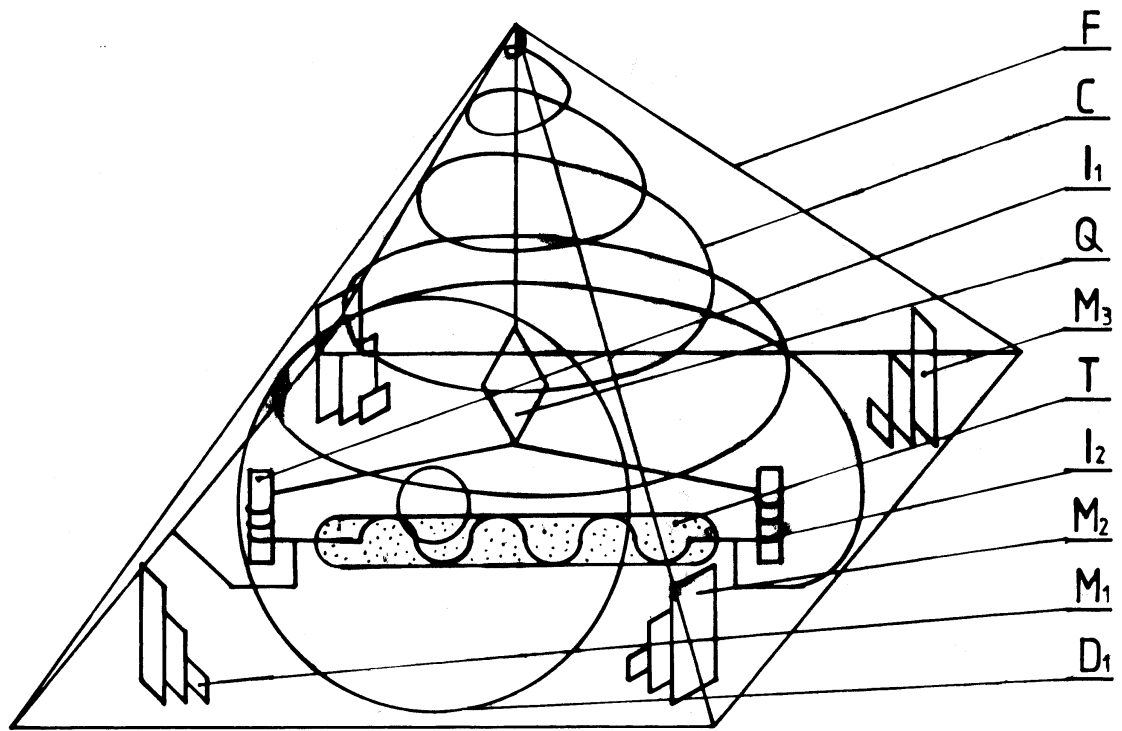

**Fig. #C3: The design of the "telepathic pyramid".** The above drawing illustrates also components of a telekinetic cell that is embedded into this telepathic transmitting and receiving device. Names and labels of subsequent components of this cell indicated on the above drawing are described below under the illustration "Fig. #C4". (The above illustration originates from [monograph \[1/5\]](#) where it is shown on Figure K2.) Apart from subsection K2.2 from volume 9 of [monograph \[1/5\]](#), the components illustrated above are briefly explained in item #C2 from this web page, and also on a separate web page about the [telekinetic cell](#).

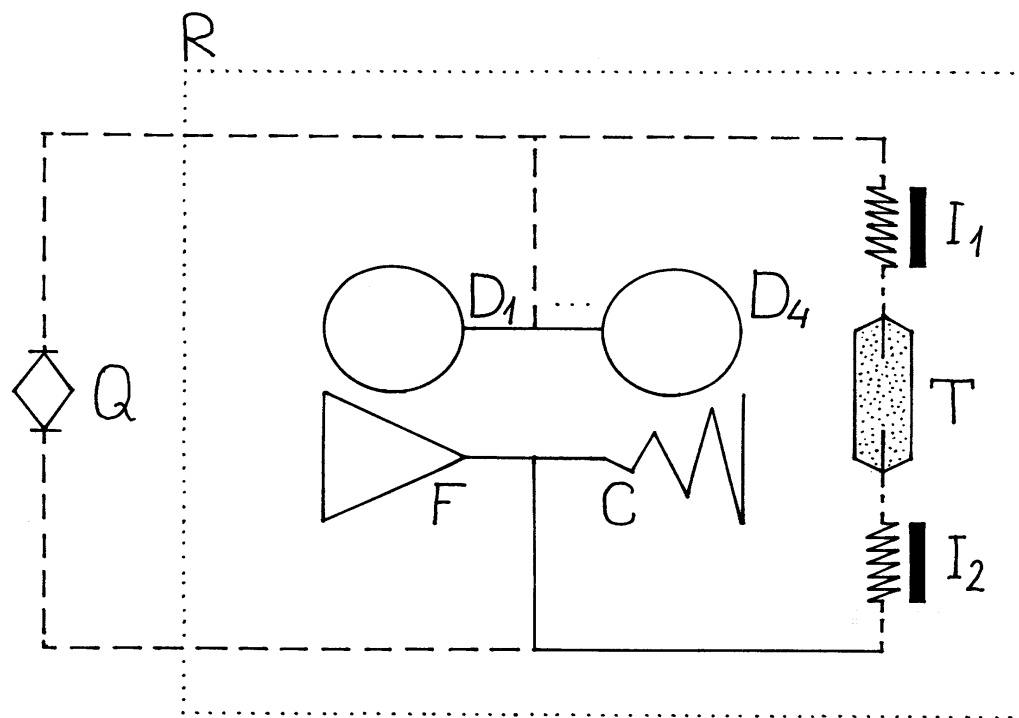

**Fig. #C4: The electrical diagram and wiring of the "telepathic pyramid".** The subsequent components of this device, which constitute a telekinetic cell and which are described on this web page include: (I1) and (I2) - telekinetic inductors, (Q) - a pulser, (R) - a resonator which is just a simple oscillatory circuit (note that two inductors (I1) and (I2) provide the inductance required for the operation of this resonator, while the vacuum capacitor formed by components marked (D1), (D4), (F) and (C) is providing the capacitance also required for work of this oscillatory circuit), (T) - the reciprocator. (The above illustration originates from [monograph \[1/5\]](#) where it is shown in Figure K3.) The description of work of subsequent components shown on this diagram, as well as explanation of the work of the entire telekinetic cell contained in this telepathic pyramid, are provided in subsection K2.4 from volume 9 of monograph [monograph \[1/5\]](#). These components are also summarised briefly in item #C3 on this web page, and on a separate web page about the [telekinetic cell](#).

## #C3. Designs of reciprocators which are already proven in operation:

Reciprocators are essential components of telekinetic cells, without which these cells refuse to work. They are also components, the necessity and the key role of which is not realised by most of present builders of free energy devices. Fortunately for us, as this is explained in details in item #4.4 of separate web page about [telekinetic cells](#), there are numerous designs of reciprocators already verified in operation. The most simple out of such designs of reciprocators, is a cluster of galena crystals probed with a "cat's whisker", which was used in past as a reciprocator for so-called "crystal radios". (These radios were supplied into electrical energy by such telekinetic cells embedded into their electronic

circuits.) More complex reciprocators contained a "tandem of quartz crystals". These were used in two working prototypes of telekinetic influenzmaschinen called "Testatica". But the most perfect one was the reciprocator constructed as a "tube" with a mixture of salt and mercury kept under vacuum. It was used in prototypes of "telepathic pyramids" shown here in "Fig. #C1". I read also in one book that someone constructed a working reciprocator (or more strictly a "coherer") by parallel connection of several transistors. Unfortunately, no details of this connection were provided in there. Further data regarding designs and operation of reciprocators are provided on the separate web page about [telekinetic cells](#).

## #C4. Operation of a telekinetic cell:

The operation of telekinetic cells is extremely simple, although it involves quite complex phenomena that are described in details in [monograph \[1/5\]](#). This operation is illustrated on "Fig.#C4" above (i.e. K3 from [1/5]). Every such a cell works because a pulser "Q" sends to it an uniform stream of electrical impulses. Each of these impulses is reinforced with additional power by inductors I1 and I2. Thus the power of each impulse is greater at the exit from these inductors, than at the entry to them. So all that is then needed, is to gather (means "add together") these small increments of power carried by each impulse, and forward them outside of the cell. This adding together is carried out by the resonator "R" which also forwards the energy so collected to the output terminal. Because the cooperation between the resonator "R" and the pulser "Q" could be hindered by the so-called "deadlocks" which occur in all oscillatory systems, there is an additional component called the reciprocator "T", which eliminates these deadlocks. It removes the deadlock points, mutually synchronises the oscillations in the resonator "R" with the oscillations from the pulser "Q", and allows this device to initiate its oscillations whenever the cell is switched on.

## #C5. How to build a telekinetic cell:

Should you have the appropriate housing conditions and personal inclinations for experimenting, finances for private research, and inventive skills, I would highly recommend to start building the telekinetic cell. However, before you begin this building, I would also recommend to read everything that describes this device, so that you understand how it operates and what phenomena occur inside of it. You should at least read volumes 1, 4, 9 and 10 (i.e. chapters A, H, K, and LA) of [monograph \[1/5\]](#). Volume 4 explains to you the phenomenon of telekinesis and the action of the Telekinetic Effect, the understanding of which is absolutely essential for the success in constructing this device. Volumes 9 and 10 explain for you the operation of free energy devices in general, and telekinetic cells in particular. They also explain for you, step by step, how to build subsequent components of these devices and what is vital in these components. In turn volume 1, explains to you the realisty which makes this device work. After you learn how this cell works, you can gather the required components, put them together, and initiate your experiments. But hurry up, because this device is urgently needed by our civilisation. Perhaps it may even save humanity from the extinction.

## #C6. Measurements of "efficiency" already have proven that primitive prototypes of telekinetic cells - which scientifically and in intentional manner were invented only by me in 1989, in an unaware and accidental manner were built-in to circuitry of so-called "crystal radios":

As I explained this more exactly in items #H1 to #H3 of the separate web page named [fe\\_cell.htm](#), almost a century ago primitive prototypes of my "telekinetic cells" were already manufactured on the Earth. They were called "crystal radios" or "crystal sets". They worked perfectly producing free electricity - only that in small amounts. In fact these were the only devices mass produced on the Earth so-far, which did not require any battery nor external energy supply, but in spite of this still correctly performed their functions. They did this because they contained a primitive version of the "telekinetic cell" embedded into their electronic circuitry - which cell scientifically, intentionally, and in an aware manner, was invented only by me in 1989, and the design of which I described on this web page.

Unfortunately, the philosophical immaturity of representatives of official so-called "atheistic orthodox science" induced detrimental explanations for the lack of need to use external electricity supply for these old "crystal radios" to sustain their operation. Namely, these atheistic scientists disseminate completely absurd claim, that supposedly such "crystal radios" retrieved energy that they need from their antennas. But, as this was revealed by my literature searches carried out for almost a quarter of century, **NO-ONE in the entire world, took the trouble to actually measure with instruments the energy balance and "efficiency" of these "crystal radios", and to empirically prove that their consumption of power from the antenna really covers the loss of energy that occurs in their headphones.** (Even if somewhere someone carried out such measurements, their results were well "buried" away, so practically almost no-one in the entire world had a chance to learn them before December 2011, when measurements of this balance and "efficiency" were completed from my initiative.) In other words, all these claims of "atheistic orthodox scientists", my superiors at universities, people discussing my inventions, etc., which for almost a quarter of century hold back the building of the extremely needed "telekinetic cells", and which cost me indescribably high amount of personal suffering, disappointments, and bad emotions, actually are "sucked from a finger" and are based just on "beliefs" of some "armchair ay-stay-nesses".

For a long I have been aware, that experimental measurement of the energy balance and "efficiency" of "crystal radios" is a most simple way of proving that inventors of these radios, without knowing it, included a primitive version of my "telekinetic cell" into circuitry of these radios. After all, if (what actually happened in 2011) the experimentally determined "efficiency" of these crystal radios turned out to be greater than 100% (i.e. turned out to exceed 100% announced by the official science as supposedly "impassable" value of the highest-possible energy "efficiency"), than this must mean that every crystal radio generates by itself the electricity that it consumes. But if the experimentally measured "efficiency" of crystal radios would turn to be lower than 100%, then this would mean that these radios really work like "atheistic orthodox scientists" tell this to naive people - i.e. that their operation is sustained due to energy absorbed from antennas. Therefore for many years I tried to persuade these people who have required condition, equipment, and

knowledge, to carry out experimental measurements of this "efficiency" of crystal radios. This is because I was completely deprived of possibilities to carry out such measurements by myself - as I am explaining this more extensively e.g. in item #J1 of the web page named [fe\\_cell.htm](#). Unfortunately, until December 2011, means for long 22 years since I scientifically and in aware manner invented the "telekinetic cell", no-one volunteered for completion of such measurements - in spite that I persistently promoted them in internet and in a number of other my publications. Only in December 2011 - for my huge happiness, a "radio-person" from Poland volunteered to carry out such measurements. His results and [measurements have proven an "astronomical" efficiency of "crystal radios", which exceeded supposedly "impassable" efficiency of 100% by so high value, that in no-case it could be e.g. just an "error in measurements"](#). In other words, to-date experimental measurements of "efficiency" of crystal radios proved beyond doubts, that these radios generate by themselves electricity required for their operation, and that the power taken from their antennas represents just a kind of "trigger" which releases in crystal radios the process of automatic generation of energy. Descriptions of the method and results of experimental measurements of "efficiency" of crystal radios is presented in "part #J" from the separate web page named [fe\\_cell.htm](#). I encourage readers to have a look at these presentations. After all, they "open our eyes", **prove to everyone who wishes to carry out required measurements, that a device with energy efficiency of over 100% can be build - so that it generates "free energy" without consuming any fuel or other kind of energy**, and also these measurements are so thoroughly explained, that more capable readers can repeat them - thus "convince themselves conclusively".

Now, when indicated was a simple experiment and a simple device, which allow to generate more energy than they consume, it should be enough to just improve appropriately these old prototypes of "crystal radios" in order to receive "telekinetic cells" of my invention providing us with abundance of energy and electrical power. So let us "roll-up our sleeves" and begin the work, because without these devices our civilisation slowly is dying. In items #H1 to #H3 of this separate web named [fe\\_cell.htm](#) is explained, step by step, how in the most simple and fastest manner we can transform a "crystal radio" in such a way, that the circuitry of this radio becomes converted into a "telekinetic cell" which generates an unlimited abundance of "free electricity".

## **#C7. Guidelines for building telekinetic cells described here, are provided in "part #H" of the separate web page named [fe\\_cell.htm](#) - about research and development of telekinetic cells:**

Finally on the planet Earth arrived the right time when the research and development on the telekinetic cell become a necessity. Therefore readers who have appropriate conditions for development and experimenting, should try their luck in building this device. Much more extensive description of it, which also includes guidelines for these hobbyists who wish to build it, are provided on the web page named [fe\\_cell.htm - about research and development of telekinetic cells](#).

But please notice, that onto production of the "telekinetic cells" of my

invention, are imposed 3 requirements, which stem from my authorship of principles of operation and design of "telekinetic cells", and thus also from my intellectual ownership of that invention. These 3 requirements are summarised in item #H1 of the separate web page named [fe\\_cell.htm](#)

---

## **Part #D: Telekinetic "influenz-maschine":**

### **#D1. What is this telekinetic influenz-maschine:**

Telekinetic influenzmaschinen are first successful "free energy" devices build on our planet, which actually work and produce an abundance of free electricity. They are currently owned by the Swiss Religious Community calling itself the "Methernitha". Unfortunately, for reasons which I am trying to explain in chapter OD of my [monograph \[1/5\]](#), Methernitha is determined to keep secret the technical details, as well as the history of these extraordinary devices. In 1991 I flew from New Zealand to Methernitha especially to see this extraordinary device. Regrettably, at that time Methernitha already implemented the iron rule to not show this machine to anyone (it was being shown to every interested person just a few years earlier). So my only benefit from that visit was to meet in person Paul Baumann - the technical genius who actually constructed the Thesta Distatica. Thus the history (and also the operation) of telekinetic influenzmaschinen that I am describing on this web page and in my publications, originate from my chance findings and also from my personal research on the technically induced "Telekinetic Effect", not from the Methernitha itself. This means that I believe that the information that I am providing here is probably correct, although I have no means to verify the correctness of it. Thus I would suggest to treat it only as a "gossip", which gives some taste of the strange fate of the most vital technical development of our civilisation.

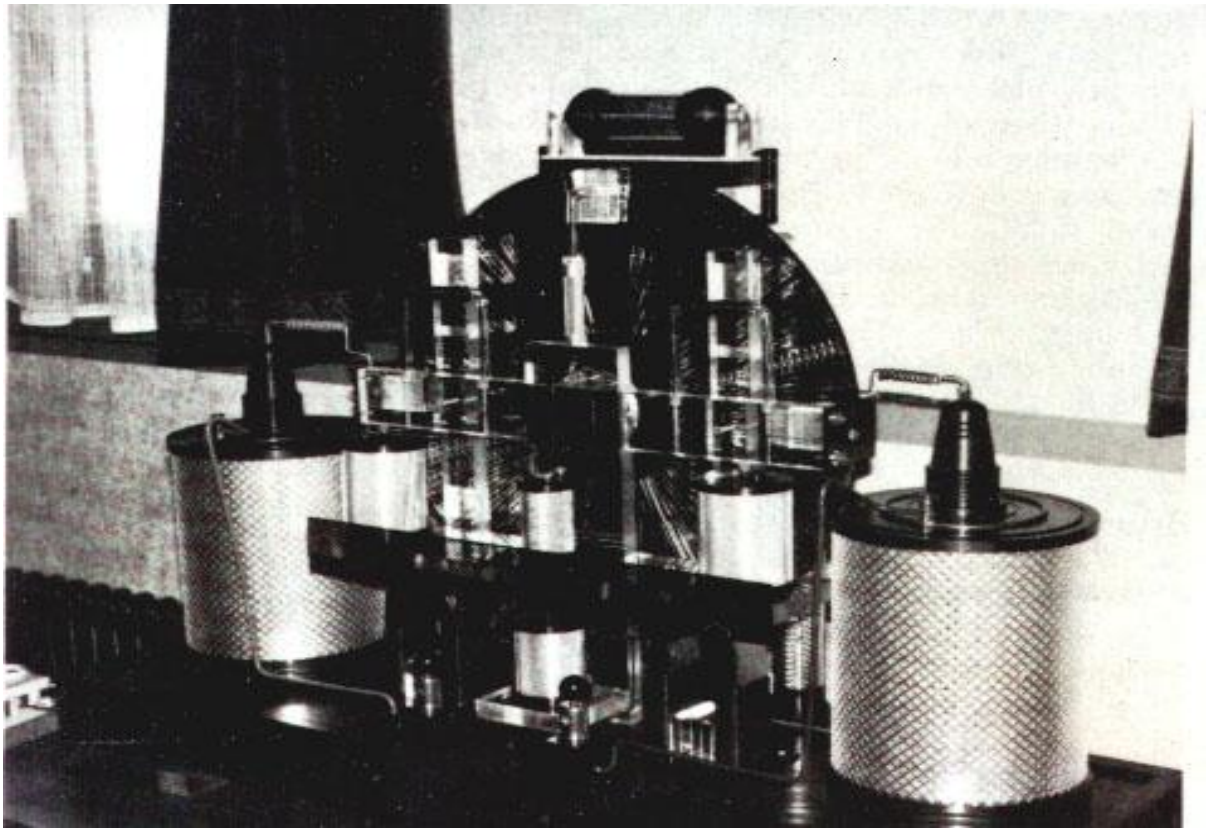

Fig. #D1: The appearance of telekinetic influenzmaschine.

## #D2. History of telekinetic influenz-maschines:

By a strange coincident I learned that the first developer of telekinetic influenzmaschinen was an Austrian citizen named Bela Brosan. He constructed the first two such devices, which actually worked successfully. His breakthrough devices had a single spinning disk, and were based on principles of the Töpler electrostatic machine. He also published a small booklet [1LA2.3.1] (editorial details referred in subsection LA2.3.1 from my [monograph \[1/51\]](#)), in which he described these devices. Unfortunately, soon after constructing his two small devices, Bela Brosan died (supposedly in quite suspicious circumstances - probably secretly assassinated by the "curse of inventors" described in item #H1 below - which curse is trying to suppress the mastery of "free energy" on the Earth). In turn his two working free energy devices were shipped to Switzerland by his helper called "Nitschel", who was known around from his "golden hands" skills, as well as from his radical religious views for which he even run into problems with local authorities. It was supposedly from this Nitschel, that the religious community Methernitha got hold of the first two these devices. Methernitha keeps them in the working order until today, sometimes showing them to the carefully selected people. They are called "Testatica". Later, by using the Brosan's working model, Methernitha build another, the third such device with two rotating disks. It was called the "Thesta-Distatica". It worked perfectly and proved itself so successful in operation, that Methernitha initiated the project of building a huge version of it with two disks over 2 meters in diameters. For my best knowledge this large free energy project is still being continued even today. More details regarding the extraordinary history of telekinetic influenzmaschinen is provided in subsection LA2.3.1 from volume 10 of my



[monograph \[1/5\]](#), downloadable free of charge from this web site.

There is a fact, which hit my eyes when I visited Methernitha in 1991, and which is conclusively disclosing who is behind this "curse of inventors" described in item #H1 below - which makes impossible for our civilisation to master "free energy devices" already now. Namely when I talked to Paul Baumann (the constructor of "Thesta-Distatica") near the gate to the building of Methernitha in which research on telekinetic influenzmaschinen is carried out, I was shocked by tens of magnetically scorched rings of grass that were present on a nearby paddock. In fact this paddock was so covered with scorched rings of grass, as that one shown in Figure V1(c) in [monograph \[1/5\]](#). In turn, from research on identical rings of scorched vegetation that exist in New Zealand, it is known to me that exactly such rings are formed during landings of "simulations" of UFO vehicles. This means, that UFO-nauts are extremely interested in fate of telekinetic influenzmaschinen. So they continually spy on people of Methernitha and hypnotically program these people to never release the technology of free energy machines outside of Methernitha. Means that UFO-nauts are behind this "curse of inventors" described in item #H1 below, which makes impossible for humanity to master the production of free energy devices. (For more information about "simulations" of UFO-nauts continually pushing our civilisation down, see the web page [ufo.htm](#), or see chapter OD from volume 13 of monograph [monograph \[1/5\]](#).)

## #D3. Components of telekinetic influenzmaschinen:

The basic part of every telekinetic influenzmaschine is a spinning disk with 50 electrodes (for the USA it must have 60 electrodes, as the North America uses AC electricity of frequency 60 Hz). This disk is visible on all illustrations of these devices. In order to make it spin at constant speed of around 60 RPM (means at the speed of 1 revolution per second), the disk is a part of an electrostatic motor that works on principles which are the reversal of principles from the Töpler electrostatic machine, or from the Wimshurst electrostatic machine. Another vital component of every telekinetic influenzmaschine is a telekinetic cell described earlier in item #C1 of this web page. This cell is controlled with electric impulses generated by the spinning disk. (I.e. these 50 electrodes of the disk spinning with the rotational velocity of 1 revolution per second, are the starting components which generate 50 Hz impulses for the pulser of the telekinetic cell.)

## #D4. Operation of telekinetic influenzmaschinen:

In the sense of principles involved in their operation, telekinetic influenzmaschinen are actually duplex devices composed of two mutually cooperating components. The first of this components is an **electrostatic motor**, which works on principles of electrostatic influence. Means this motor uses principles of operation that are exact reversals of principles utilised in either the Töpler machine, or in the Wimshurst electrostatic machine. (As you probably know, in electricity principles of motors and generators are mutually reversible. This means that principles applied in every electric motor can be reversed so that they produce a generator of electricity. Also principles of every electricity generator can be so reversed that

they produce an electric motor. This reversibility applies to principles utilised in the Töpler and the Wimshurst machines.) The second component of telekinetic influenzmaschinen is a **telekinetic cell** described before in item #C1 of this web page. This cell generates free electricity which is used for sustaining the motion of the motor. Both together, means the motor and the telekinetic cell, form a telekinetic influenzmaschine which not only produces a visible mechanical motion without the need for any energy supply, but also produces a surplus of free electricity which later can be supplied to other electrical appliances in order to power them.

Earlier on this page, while describing telekinetic cells I also mentioned, that in order to make these cells work, a series of electrical impulses of the constant frequency 50 Hz for Europe and 60 Hz for the USA must be supplied to their entry. In order to generate these impulses, telekinetic cells include a special component called the "pulser". These impulses are later reinforced by the Telekinetic Effect released in inductors (I1) and (I2). In telekinetic influenzmaschinen these impulses are generated by the electrostatic motor described before. To generate them, the motor used in Europe must have a disk with 50 electrodes (the disk used in the USA must have 60 electrodes). This disk must rotate with the constant rotational velocity of 60 rotations per minute (RPM) - means 1 revolution per second. The result is, that if in front of this disk we place the "impulses' collecting head" marked "ho" on Figures "Fig. #D2" and "Fig. #D3" (or LA5 and LA6 from [1/5]), a series of AC impulses of frequency 50 Hz in Europe (or 60 Hz in the USA) are induced in this head. Thus, this head "ho", together with electrodes of the spinning disk, represents a "pulser" for the telekinetic cell. If now these 50 (or 60) Hz impulses we feed from this collecting head the telekinetic battery, the battery is going to telekinetically generate 50 Hz AC electricity for Europe, or 60 Hz for the USA. A part of this AC electricity must be redirected back to the electrostatic motor to supply it into energy and thus to keep it rotating. The rest can be supplied outside of the device and directly utilised in our home appliances. And this is how telekinetic influenzmaschinen do work. Of course to construct them, we must solve several technical problems. One of these is the maintenance of the constant speed of 60 RPM at the rotating disk. On the accuracy of this constant speed depends the frequency of free electricity being generated. To solve this problem, it is necessary to add special "speed controller" to the design of the electrostatic motor. This controller is formed through linking mechanically the electric motor used as the main part of telekinetic influenzmaschinen, with an additional small spinning spindle which holds a small controlling dynamo-motor. This dynamo-motor has the "opposing" electrical connection (i.e. the positive feedback) with the main motor of the telekinetic influenzmaschine. In Figure "Fig. #D3" (or LA6 from [1/5]) this controlling dynamo-motor is marked as "Ts". This dynamo-motor causes, that when the main motor runs too fast, the "Ts" begins to work as a dynamo, means starts to generate electricity that counteracts the electricity which propels the main motor, thus slowing this main motor down. In turn when the main motor runs too slow, this "Ts" dynamo-motor switches itself onto the operation as an additional small electric motor, which adds rotational power to the influenzmaschine, thus causing the disk to rotate much faster.

Note that the original inventor and developer of telekinetic influenzmaschinen (i.e. Bela Brosan) was to produce with them the free mechanical motion, not the free electrical energy. However, later users of these devices had no clue about principles and phenomena involved in their operation. So they were unable to extract the telekinetic cell from the entire telekinetic influenzmaschine, to generate electricity much simpler with this cell alone.

## #D5. If you are one of developers:

Numerous people attempted to replicate the telekinetic influenzmaschine called "Thesta Distatica" - this one shown in Figure "Fig. #B1" above (or LA4 from [1/5]).

Unfortunately, so-far all these people failed. In fact, even the Methernitha - which actually have already three working models of telekinetic influenzmaschinen, experiences unbreakable difficulties in replicating them at a large-scale. The reason is, that all these people try to mimic the components and the physical structure of the original "Testatica" or "Thesta-Distatica" devices, without actually understanding how these devices work and what principles they employ. So if you are one of these people experimenting with free energy, please do not repeat the same error. Start your developments from actual learning and understanding how free energy devices in general, while telekinetic influenzmaschinen in particular, do work. Only then replicate in your own device their principles of operation, instead of thoughtless mimicking their physical structure and components. Only in such a case you may succeed. And we all wait for your success, because we all desperately need free energy.

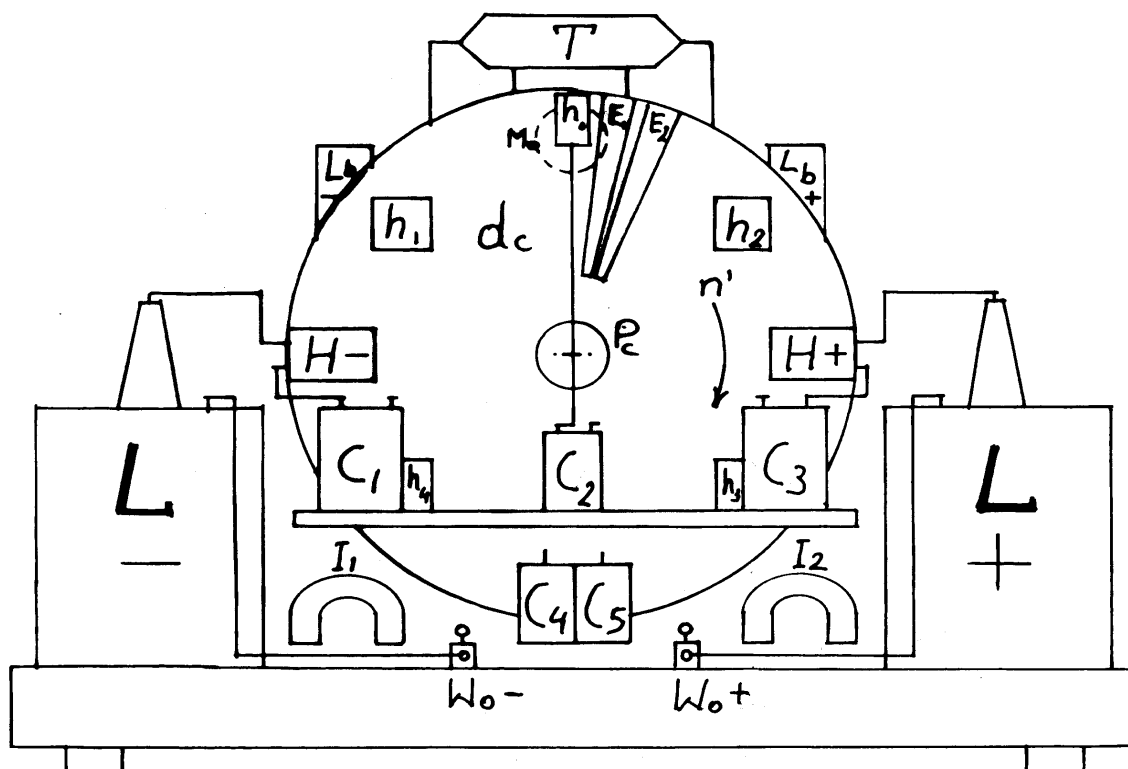

**Fig. #D2: Major components of telekinetic influenzmaschinen.** The list of these components and their operations are explained in subsection LA2.3.3 from volume 10 of [monograph \[1/5\]](#). Some of these components are described on this web page, when principles of operation of telekinetic influenzmaschinen and telekinetic cells are being explained. (The above photograph originates from [monograph \[1/5\]](#) where it is shown on Figure LA5 "b".)

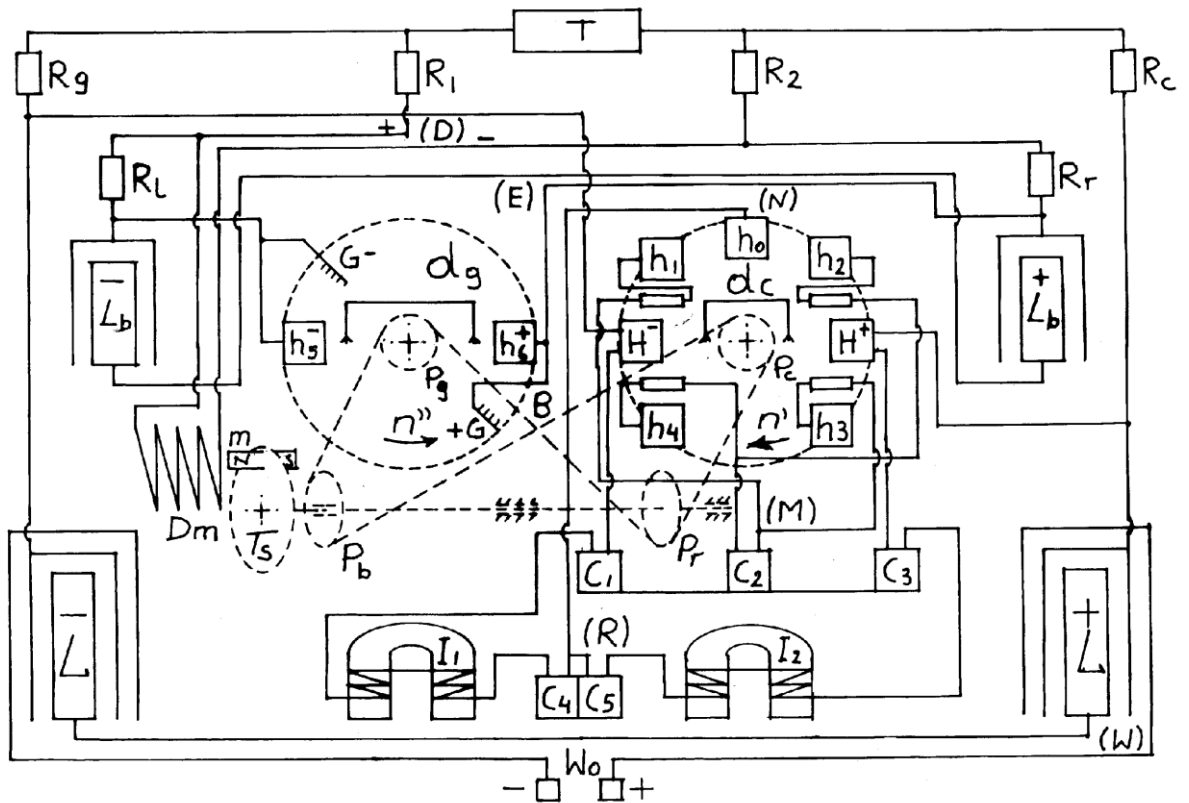

Fig. #D3: The electrical diagram for telekinetic influenzmachines. Copyright © 1998 by Prof. dr Eng. Jan Pajak. The description how subsequent components shown on this diagram work, as well as the explanation of work of the entire telekinetic influenzmaschine, are provided in subsection LA2.3.3 from volume 10 of monograph [monograph \[1/5\]](#). To some of these components we are going to refer in the further part of this web page, when the principles of operation of influenzmachines and free energy devices are explained. (The above photograph originates from [monograph \[1/5\]](#) where it is shown on Figure LA6.)



**Fig. #D4:** The photo from this Figure presents me (i.e. [Dr Jan Pajak](#)) holding the brand new Wimshurst electrostatic machine that I purchased in Poland for around \$100 in a shop then called CEZAS, that supplied schools with teaching aids. (The above photograph originates from [monograph \[6/2\]](#) where it is shown on Figure 11.) This Wimshurst electrostatic machine can be converted into an electrostatic motor, which in turn can be supplemented with a telekinetic cell (described in item #C1 of this web page) which supplies this motor with electricity, and together they can be used as the main component of a telekinetic influenzmaschine. Actually I purchased the above machine with the intention that I convert it into a telekinetic influenzmaschine. At the time of this purchase I still was doing open and non-camouflaged research on the Telekinetic Effect and on free energy devices at the University that I was then lecturing. I also still believed, that I may build over there one of free energy devices that I invented and worked out at that time.

By the way, note the most prominent cluster of buildings right behind me - at the level of my shoulder blades. These are from the university campus where I actually invented telekinetic cells and explained the operation of free energy devices presented on this web page. This university is the site of my first (hopelessly lost) battle with orthodox scientists regarding the inclusion of free energy devices and the Telekinetic Effect, into the area of interests of the mainstream science. I intended to build at this university my free energy devices in order to prove that they actually work. I also intended to present papers and articles about these wonder devices. Unfortunately, my superiors from that university disallowed me to present even my first research paper on these devices on a scientific conference in Australia, in spite that this paper went through referees and was accepted for the conference. According to the opinion of my superiors, the paper supposedly run against established canons of the present science (referees which reviewed my paper on the behalf of organisers of this conference did not think so). Also soon after I finished purchases of components for my free energy devices and was just about to start their physical construction, I lost my lecturing job in 1990, thus making impossible to carry out any further research and development on these wonder devices. The paper that I was disallowed to present, was later converted into a scientific treatise. Now it constitutes a major part of

[monograph \[6\]](#) on "free energy" available through this web page. In turn this strange coincidence in timing of my loss of the lecturing job on that university, and my invention of the "telekinetic cell", implanted an idea into my mind, that perhaps some sort of a [curse of inventors](#) works this planet, which tries to prevent our civilisation from constructing these wonder devices now and from mastering now the "free energy". My later research confirmed this idea, proving that practically all outstanding inventors and all breakthrough inventions are persecuted by a mysterious "**curse of inventors**" described in a larger number of details in item #H1 below, as well as in a number of other my web pages - for example in item #B4.4 from the web page named [mozajski uk.htm - about the inventor of the first airplane in the world](#), in item #G3 from a separate web page [eco cars.htm - about pollution-free cars](#), in item #K3 from a separate web page [fe cell.htm - about telekinetic cells](#), and in several other web pages. This "curse of inventors" either assassinates developers of free energy devices - as it probably did to the Austrian, Bela Brosan (i.e. the builder of first telekinetic influenzmaschinen), or it locks operational such devices in power of some impenetrable communities - as it probably did with two "Testatica" and with one "Thesta-Dlstatica" influenzmaschinen, or it continually persecutes researchers who investigate "free energy devices" - as it for sure is doing to me since the time of inventing these devices (for more details on this, see subsection OD from volume 13 of [monograph \[1/5\]](#).) It is worth to know about the existence of this "curse of inventors" (described in item #H1 below), because every developer who attempts the construction of "free energy devices" and is close to a success, always encounters numerous obstacles that this [curse of inventors](#) places on his or her path.

## #D6. How to build a telekinetic influenzmaschine:

The simplest manner of building a telekinetic influenzmaschine is to start from constructing an AC motor working on principles of electrostatic influence. Such a motor needs to be simply a reversal of either the Töpler machine, or the Wimshurst electrostatic machine. Actually such a motor can be purchased almost ready made, as many countries, including Poland, offer brand new Winshurst electrostatic machines for sale in shops. These ready-made machines look as it is shown in "Fig. #D4" above (or 11 in [6/2]). The problem is, however, that the Töpler and the Wimshurst machines both work as electrostatic generators. Namely they produce static electricity while consuming mechanical motion. To convert them into influence motors, it is necessary to reverse their principles of operation. So they must be able to produce motion when their capacitors are supplied with AC electricity. After we have such an electrostatic motor working, we need to use one electrode from it as a pulser. Means we catch the electric impulses that this motor generates, with the brush marked "ho" on illustrations "Fig. #D2" and "Fig. #D3" above (or LA5 and LA6 in [1/5]). Then we feed these impulses into a separate telekinetic cell that we attach to our motor. These impulses are going to make our telekinetic cell work. So we can feed now the output from this telekinetic cell back into the capacitors of our motor. In this way we receive a duplex operation of the resultant device, composed of the electrostatic motor, and the telekinetic cell. In this duplex operation the motor produces electric impulses which sustain the operation of the telekinetic cell, in turn the telekinetic cell generates electricity which sustains the operation of the motor. So the resultant device is going to operate exactly the same as does the Thesta Distatica shown previously in "Fig. #B1" (or LA4 in [1/5]). (This practically means that the description that I am providing here is also a description of the true operation of the Thesta Distatica constructed by the Swiss religious community "Methernitha".) Our device is to produce mechanical motion, plus plenty of free

electricity, the excess of which can be utilised by us for supplying other electrical appliances.

## **#D7. Guidelines for building devices of telekinetics, including the "telekinetic influenz-maschine" described here, are provided on the separate web page [telekinetics.htm](#) - about the experimental construction of devices for telekinetics:**

Finally on the planet Earth arrived the right time when the research and development on devices of telekinetics become a necessity. Therefore readers who have appropriate conditions for development and experimenting should try their luck in building such devices. Much more extensive description of these devices, which also includes guidelines for these hobbyists who wish to build them, are provided on a different web page [telekinetics.htm](#) - [about the experimental construction of devices for telekinetics](#).

---

## **Part #E: Devices for the generation of thermal free energy:**

### **#E1. [A Davey's heater:](#)**

The Telekinetic Effect can also be utilised to generate various other forms of "free energy" than just electricity. There are devices already build and tested in action, which utilise the "reversal of friction" capabilities of this effect for converting environmental thermal energy into energies other than electricity. For example, on the web page named [eco cars.htm](#) are described devices which generate chemical energy by converting environmental heat into products of dissociation of water to hydrogen and oxygen - which gases then can be burned as fuels in "cars run on water". There are also free energy devices which produce heat. Several out of these are comprehensively described on a separate web page named [boiler.htm](#). This last application of the Telekinetic Effect allows to construct telekinetic heaters, which have the efficiency exceeding 100% - see item #E8 below.

In this part of the web page I am going to describe briefly a heater, the inventor of which claimed that it has the energy efficiency reaching 2000%. This means that if properly constructed and tuned, it would consume the amount of electrical energy that represents only around 5% of the total energy that it produces in the form of heat. The inventor of this heater is the late Peter Daysh DAVEY (Senior) of Christchurch, New Zealand. Unfortunately, later research completed by a Polish hobbyist and described on a separate web page

named [boiler.htm](#), revealed that this huge claimed efficiency cannot be confirmed by measurements, and thus perhaps may just be an error in judgement. However, the fact remains, that the so-called "curse of inventors" described in item #H1 of this web page generates an immensely huge force to prevent this "Davey's heater" from being implemented. In turn the "curse of inventors" works intelligently in such a manner that it holds back the implementation of an invention with the force which is proportional to the significance of that invention to our civilisation. This in turn suggests (according to the content of item #H4 below on this web page), that the "Davey's heater" for sure hides some vital secret, the discovery and research of which are to bring about to our civilisation (and also to the person and nation that is to implement this heater) some huge benefits and immense advancement of civilisation. No wonder that in spite of results of measurements of that Polish hobbyist, still I am contacted by people who claim that they already constructed this heater and that according to their estimates their heating of homes with it, is much cheaper than e.g. the use of "heat pumps".

The design of the Davey's telekinetic heater is extremely simple. It actually is composed of two major parts only – see "Fig. #E2" (or LA8 (3) from monograph [monograph \[1/5\]](#)). The most important out of these two parts is a resonating hemispherical bowl (1) made of a sound inducing metal plate. The second part is a buffering hemispherical bowl (2) almost identical in shape to the bowl (1). This second bowl has the radius around 4 to 6 mm larger than the resonating hemispherical bowl (1). Both bowls are assembled symmetrically one around the other, means the hemispherical bowl (1) is placed inside of the hemispherical bowl (2). Of course, apart from these two bowls, the heater also includes a long pipe (8) which holds remaining parts together, two nuts (5) and (3) which fix both bowls in their proper locations, a washer (4) which allows to regulate the mutual distance "L" between both bowls, and electrical wires (6) and (7) which supply electricity to both bowls and allow the heater to be submerged into water that it heats. But these other parts are marginal additions only. The major parts are the bowls. During experimental production of this heater, the resonating hemispherical bowl (1) usually is made from an old cover for a bicycle bell. The dimensions of this hemispherical bowl are not important. It is only vital that it falls into a sonic resonance at the frequency of 50 Hertz, and that it has the outer surface which is parallel and equidistant from the external buffering hemispherical bowl (2). To each of these two bowls a different wire of the household electricity supply (i.e. 220 V, 50 Hz) is connected. The heater must be submerged in water that it heat. It brings water to the boiling point extremely fast. More details about the design and operation of this telekinetic heater is provided in subsection LA3.3 from volume 10 of monograph [monograph \[1/5\]](#).

After being constructed, the Davey's telekinetic heater must be "tuned" in two different manners. The first tuning depends on providing the hemispherical bowl (1) with such frequency of the own oscillations, that makes this bowl to resonate acoustically when a sound of the frequency 50 Hertz is emitted nearby. The second tuning of the heater depends on appropriate selecting the distance "L" between both bowls (1) and (2). On this distance depends the formation of the standing wave between both bowls. Thus it decides about the energy efficiency of the entire heater.

The principle of operation of this telekinetic heater is quite similar to the principle of operation of the telekinetic battery explained before. Namely the Telekinetic Effect is released in it due to the acceleration and deceleration of magnetic field. The magnetic field that is accelerated, is the one that is generated by the electric current which flows through water between both bowls. In turn the acceleration of this field is accomplished through sonic vibrations of the inner bowl. The required asymmetry of the vibrations of the field, which is required to generate the Telekinetic Effect, and which in the telekinetic battery is caused by permanent magnets inside of coils, in this heater is provided by the curvature of the bowls. Thus the inner hemispherical bowl in this heater is doing the same job as the inductor (I1) is doing in the telekinetic cell.





**Fig. #E1: The telekinetic immersion heater invented during the World War Two (in 1944) by the New Zealand fighter pilot and musician named Peter Daysh Davey. The main component which releases the Telekinetic Effect in this heater, is the inner resonance bowl visible on the very right side, as it sticks out from the outer buffering bowl. (The old New Zealand 50 cents coin, visible on this photo, is 32 mm in diameter. In August 2006 these coins were withdrawn from circulation.) This mechanically simple device generates many times more heat, than the amount of electrical energy that it consumes. Thus it has the energy efficiency of significantly exceeding 100%. It is probably one of the most simple free energy devices in existence. It was proven in action and subjected to measurements by numerous scientists. However, the mass production of it was purposely blocked by the means of bureaucratic obstacles - for details see the "curse of inventors" described, amongst others, in item #H1 of this web page, and also in item #G3 from the web page named [eco cars.htm](#), in item #K3 of the web page named [fe cell.htm](#), and in several other web pages listed before. (The above photograph originates from [monograph \[1/5\]](#) where it is shown on Figure LA8.)**

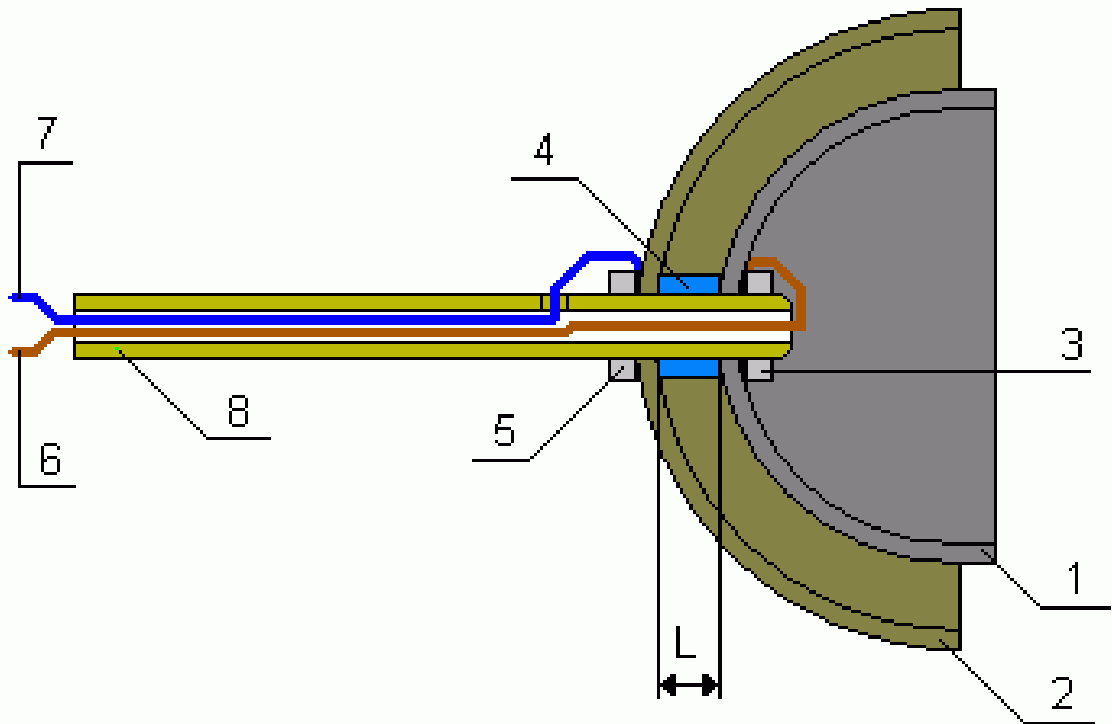

**Fig. #E2:** The above drawing illustrates the general design and main components of the telekinetic heater of Mr Davey. Notice that it can easily be enlarged by clicking onto it. Descriptions of subsequent components of this heater are provided in subsection LA3.3 from volume 10 of [monograph \[1/5\]](#). (The above illustration originates from [monograph \[1/5\]](#) where it is shown as part (3) on Figure LA8 - courtesy "szod".)

Symbols: (1) - a "resonating bowl" which is to be connected to the "life wire" of the electricity supply, (2) - a "buffering bowl" which is to be connected to the "neutral wire" (also called the "return wire") of 50 Hz electricity supply, (3) and (5) - two nuts which fix both bowls in their proper locations, (4) - a washer which allows to regulate the mutual distance "L" between both bowls during the second stage of tuning of the heater for the energy consumption (this distance should be around  $L = 4$  to  $6$  mm), (6) - the electrical wire which connects the "life wire" of 50 Hz electricity supply with the "resonating bowl" (1), (7) - the electrical wire which collects electricity from the "buffering bowl" (2) and sends the current to the "neutral wire" (also called the "return wire") of the 50 Hz electricity supply, (8) - a long assembly pipe means a kind of "frame" for this heater which holds remaining parts together.

\* \* \*

If you wish to **shift** a given Figure (i.e. a photograph or a drawing), means to **move it into another part of the screen where you are just reading a description of it**, you need to do as follows: (1) click on it to make it appear in another window, (2) the "downsize" this another window (with a given photograph or drawing) through "grabbing" its right-bottom corner with your mouse and then dragging this corner upwards-left to receive the size of this different window that you wish to have (notice that since you downsize a first such a Figure, all next Figures clicked on will appear already downsized - unless you enlarge them in the reversed manner), and then (3) drag this another window with the picture that you wish to relocate to the area of this web page where you wish to look at it (to move it, you just grab it with your mouse by the blue stripe on the top of it). Notice also that if you scroll (with scroll bars) the text of the page when you read it, this another window (with the drawing) will disappear. In order to return it into the new position, you need to click on its "icon" (i.e. on the "program's button" from the taskbar) in the lowest part of the

screen.

## #E2. The energy efficiency of this heater:

The inventor of the Davey's heater claimed, that it was experimentally proved to shift to the heated water many times more thermal energy than the amount of electrical energy it consumes. I myself did not research the energy efficiency of this heater. However, from the information that the inventor repeated to me, I gather that the measurements carried out by New Zealand scientists suggested that this heater may consume even less than the equivalent for around 5% of the energy that it generates in form of heat. This would indicate, that the electrical efficiency of this heater would be around 2000%. (Means, that the heater would produce over 20 times more heat than it consumes electrical energy.) In turn so huge efficiency of this heater would allow it to be used for constructing the so-called "perpetuum mobile" (means to e.g. evaporate water with this heater, use the steam that it produces to run a steam engine, while the motion from the steam engine use to generate electricity which would supply the heater with the energy required to evaporate water, etc., etc.) Several orthodox scientific institutions in New Zealand supposedly had a very hard time to explain on the basis of today physics what is the reason for this supposed over 100% efficiency of this device. After all, it would contradict all known laws of thermodynamics. Finally one of these institutions (i.e. the New Zealand DSIR) got an idea, or rather an accusation, that this heater instead of the electric current may consume the so-called "cosine fi" - i.e. the abstract quantity that represents a phase shift between the pulsations of the voltage and pulsations of the amperage in the alternating current. This particular parameter is immeasurable with the standard electrical instruments. But even the specialized measurements and research carried out by these scientists have not confirmed this claim (accusation). Still, in spite that it was never confirmed experimentally that this heater actually consumes the "cosine fi", due to insisting on this explanation, the authority of the orthodox science was saved.

The later research completed by a Polish hobbyist revealed, that this huge efficiency of the heater cannot be confirmed with measurements, and thus probably is just an error in judgement which results from the fact that the heater "makes an impression" that it already boiled water almost immediately after it is inserted into this water. But in reality this impression may result from the formation by it gases and steam bubbles even when the water is still almost cold. Measurements of this Polish hobbyist suggest, that probably the energy efficiency for this heater is similar like for resistance heaters. Unfortunately, the measurements that this Polish hobbyist make, were based on the "specific heat". On the other hand, measurements based on the "specific evaporation heat" can yield different results. After all, benefits and cheapness of the use of that heater reveal themselves when it is applied to heating the home, not when it brings water to boiling. But in order to measure such its efficiency during evaporating of water (for the use in homes' heating), a new method of measuring would need to be developed (which method, as so-far, remains unknown) - for more details see the separate web page named [boiler.htm](#). It is also worth to add, that the same research by the Polish hobbyist revealed as well, that even with the energy efficiency close to 100%, this heater - after appropriate modification of its design and principles of operation, probably is to introduce an immense progress to our civilisation.

## #E3. Potentials for causing a scientific

## revolution:

All data suggest, that the Davey's heater hides potentials for causing a real revolution in the Earth's science and technology. The reason is that it unleashes the technically induced telekinesis, that it creates phenomena that cannot be explained by orthodox science to-date, and also that it allows to accomplish effects that so-far were considered to be "impossible" - e.g. effectively transforms water into hydrogen. This means that a popular use of this heater would inspire new areas of research and new quest for answers. Therefore, should this extraordinary heater be put into mass production at the time when the inventor intended it, means in 1945, by now it would completely turn upside down the human science and technology. So the technically induced telekinesis, instead of being explained by myself only in 1989, would actually be explained by some other scientist at least 40 years earlier. In turn the explanation of principles of technical telekinesis, would lead to the development of telekinetic propulsion systems, of the type used in the [Magnocraft](#) described on my web pages [telekinesis.htm - about the phenomenon of telekinesis](#) and [propulsion.htm - about the propulsion of Magnocrafts](#). It would also inspire our understanding of human telekinesis (psycho-kinesis) and attributes of the human mind which induce human version of telekinetic motion.



**Fig. #E3: Mr Davey (this distinguish gentlemen with a beard), photographed with me (i.e. with [Dr Jan Pajak](#)) in 1990. (Click on this photograph to see it enlarged.)** Mr Davey holds a kind "world record" in the fight with "[bureaucracy](#)" for the permission to implement his boiler to an industrial production. After all, since 1944 (in which year he invented his boiler) till 2008 (in which year he explained in the news report, described here in item #E6, that he still fights for the implementation of his boiler to a factory production) already over 60 years have passed. More about his unique "world record" is written in item #B3.1 from a separate web page [newzealand.htm - about New Zealand](#). In turn the extraordinary boiler of his invention is described not only on this web page, but even more comprehensively on another web page [boiler.htm - about the](#)

[revolutionary boiler which bits all possible records](http://www.stuff.co.nz/thepress/4379593a6530.html). The boiler of Mr Davey was publicised in 2008 in the article entitled "Sax notes lead to off-beat boiler", on page A13 of the New Zealand newspaper from Christchurch, named [The Press](http://www.stuff.co.nz/thepress/4379593a6530.html), issue dated on Wednesday, January 30, 2008. At the beginning of February 2008 the text of this article was also accessible in Internet under the address <http://www.stuff.co.nz/thepress/4379593a6530.html>.

## #E4. Persecution of the inventor:

The story of the invention of this heater is both, very inspiring, and also very sad. Mr Davey was a musician who volunteered to defend freedom and his country as a fighter pilot during the World War Two. He took part in the Battle for Britain. Fighter aeroplanes of that time had propellers and engines, which during acrobatics of aerial battles were making the pilots cabin to vibrate at various frequencies. As a sensitive musician Mr Davey noticed, that there was such a frequency of the motor and propeller buzzing, when the aeroplane cabin and his body were getting into a resonance. At this unique resonance frequency he always was experiencing an influx of heat in his aeroplane cabin. He did not know yet, that in future this phenomenon will be utilised in ultrasonic weapon systems for effective and undetected killing of people. But he decided to test whether the same phenomenon is to appear, if a metal hemisphere which simulates his pilot cabin is submerged in water and is excited into a resonance frequency of an AC current. So he found two tops from old bicycle bells, joined them together, tuned one of them to 50 Hz frequency, attached electricity wire to each one of them, and thrown them into water. Surprisingly, water started to boil extremely fast. So he made his first heater patent based on this observation. This patent was already registered in 1944.

After a hero return from the war, he had a device, which repetitively proved to everyone who measured it, that it has the efficiency decisively exceeding 100%. Realising this, he believed that the world is going to pounce on the opportunity of production and use of this technical miracle. After all, people are full of declarations about apparent saving on energy, resources, about protection of our natural environment, etc. However, the reality turned out to be completely opposite. Immediately after it was experimentally confirmed that the device has unexplainably high efficiency, the heater and the inventor fell into disfavour of various institutions that are interested in selling electricity and that protect the monopoly on electrical power. In the result, this extraordinary invention received an extraordinary treatment! Namely authorities were doing everything in their powers to disallow the production and sale of this heater in New Zealand. One of legal tricks that were used against this heater, was that it was declared officially to be "unsafe to health and life of users". (Please notice that practically every electrical device working on 220 Volts can be declared unsafe, if someone in the position of authority wishes to put it down.) In turn in New Zealand it is impossible to undertake the production and sale of anything, that is not officially approved by the government. In the result, Mr Davey was fighting for almost 50 years to receive a permit for the industrial production of this heater. And during these almost 50 years, the permission was continually refused to him, no matter what research outcomes he submitted to please authorities, and no matter how hard he tried. But it is interesting, that in Australia an electric jug with a heating element of the design very similar to the Davey's heater was put in mass production (this Australian jug most probably is produced in there still even today). This Australian jug is working on the principle of electrical resistance of water (i.e. not telekinesis as the heater of Mr Davey does). Water that it heats is a resistor, in which heat is generated because of the electric current flows through this water. This Australian jug is exactly the same "dangerous to the health and lives", like the telekinetic heater of Mr Davey. Only that it did not encountered in Australia

similar bureaucratic resistance because the energy efficiency of it is "normal".

When I met Mr Davey for the first time in 1990, he still was appealing to authorities, and still had a hope to receive a permit for the production of his heater - in spite of these almost 50 years of lost battles with bureaucrats. He was even showing to me a large stock of components he gathered to start a production immediately after the permit is granted to him. However, he gave up the experimental production of research copies of his heater. Even the heater he was using by himself, was then already broken and he had no the will to repair it (this broken heater is shown on the photo "Fig. #E1" above). So practically I had no pleasure of seeing his heater at work. However, he run out of his usual optimism when I talked to him for the last time shortly before I needed to leave New Zealand in 1992 to seek my bread overseas. Then he was completely destroyed, deprived the will to live, and on the edge of a nervous breakdown. His most recent appeals were again squashed. He could not understand then, why offering to the world a breakthrough free energy device of the experimentally proven efficiency that well exceeds 100%, he receives back only scoffing, persecution, and bureaucratic plus legal obstacles that make impossible the production of this miraculous device.

## **#E5. Closing my contacts with Mr Davey caused by the demolition of his house in 1998 and disappearance of his name from the telephone book:**

In 1998 I returned to New Zealand from my bread-seeking globetrotting. After the return I initially lived in Dunedin - means a city which is distant from Christchurch by around 360 km. But near the end of 1998 I went into a trip through New Zealand in search of a job. In this trip I passed through Christchurch in both directions, means two times. Of course, each time I travelled through Christchurch I attempted to contact Mr Davey. But when passing through Christchurch for the first time, I discovered that the home of Mr Davey was just being demolished. In the day when I was there, the demolished was already a half of the house, although the veranda of it, and also stairs which led to the flat of Mr Davey, still stood undamaged. When I was passing there again on my way back, in the place where his home stood previously, I found only a large pile of broken wooden planks mixed with broken bricks. It looked as if several heavy tanks rolled through his home. In turn no even a trace of him. I also was unable to locate anyone, who would know what actually happened to him. His name and address disappeared from the telephone book. So I thought that's the end. After this event I ceased further visiting his home, although in 1999 I still went to Christchurch several times. In turn after 1999, as I explained this in subsection W4 of [monograph \[1/5\]](#), it has not been in my fate to let me go to Christchurch again.

From the silence which then started to prevail in matters of the Mr Davey's heater I realised that this heater was gradually forgotten in New Zealand. It was no any help to it, that the energy efficiency of this heater was proven at the miraculous level of many times above 100%. Also the fate of the inventor himself remained unknown to me. When I talked to Mr Davey for the last time, I promised him to publish the description of his heater and the story of his lifetime battles, so that perhaps someone else picks up his fight and puts this miraculous heater into a mass production. In this way his long suffering and his brilliant invention would not be wasted, and would start to work for the good of our civilisation. Descriptions from the web page [boiler.htm - about the shocking history of](#)

[revolutionary boiler that bits all records](#), and also from this web page, were prepared as my fulfillment of that old promise.

## **#E6. News item in TVNZ 1 on 30 January 2008, at 11:00 pm, which demonstrated the operational boiler of Mr Davey:**

Everything that I described on this web page in above items #E1 to #E5, represents the state of my knowledge about the boiler discussed here as for years 1990 to 2007. However, at the beginning of 2008 it turned out that the matter of this boiler is continuing. Namely, on Wednesday, 30 January 2008 at almost exactly 11:00 pm, in the evening news from channel 1 of the New Zealand television, a documentary report was broadcasted about Mr Davey and his boiler. The report lasted only for around 3 minutes. (The reader probably can purchase from "TVNZ 1" a disk DVD with recording of this report.) In this report almost an instant action of the newest version of this boiler was demonstrated. The boiler make water boil in just several seconds. This report also informed that Mr Davey is already 92 years old, and that he still fights for the implementation of this boiler to a factory production. In this way his struggle extends to over 60 years - thus giving to him a kind of "world record". More about this "world record" is written in item #B3.1 of the separate web page [newzealand.htm - about New Zealand](#), and also on another web page fully devoted to the description of this boiler, which page is named [boiler.htm - to inform about this revolutionary boiler which bits all possible world records](#). The report also implied that Mr Davey still lives in Christchurch. In turn this information allowed me to contact him again - as I described this more comprehensively on that separate web page [boiler.htm - about the boiler that bits all possible records](#).

I managed to notice in this brief news item that the version of the boiler shown in there solves already the problem of safety because of which this boiler previously was refused to get permission for a factory production. Namely, in this new design the "buffering bowl" (see "2" in "Fig. #E2"), has already the form of almost a completely closed sphere - instead of the hemisphere as the one shown in "Fig. #E2". To this buffering bowl the "zero" ("ground") wire of the electricity supply is connected. This causes that the buffering sphere completely closes the access to the "resonating bowl" (see "1" on "Fig. #E2"), to which connected is the supply voltage (i.e. the life wire of electricity supply). In this way the fully spherical "buffering bowl" (2) makes impossible to the user an accidental touching the bowl (1) to which the supply voltage is connected. This in turn prevents possibility of accidental electrocuting the user. I am very interested to see whether, after solving this problem, Mr Davey manages to implement this boiler to a factory production. Especially that the existence of this boiler took as long as until 2008 to be finally revealed to New Zealanders via the news item in TVNZ 1, and also via the article in the New Zealand newspaper from Christchurch, named [The Press](#), issue dated on Wednesday, January 30, 2008. (This article was published on page A13 of The Press. It was entitled "Sax notes lead to off-beat boiler". At the beginning of February 2008 the content of this article was also available in the Internet under the address <http://www.stuff.co.nz/4379593a6530.html>.)

## **#E7. Useful guidelines for builders of the**

## **heater described here are provided on another web page [boiler.htm - about the shocking history of revolutionary boiler that bits all records:](#)**

The heater described here is rather simple to manufacture. Therefore readers who have appropriate conditions for experimenting could easily try their luck in building this device. Much more extensive description of it, which also includes guidelines for these hobbyists who wish to build it, are provided on a different web page [boiler.htm - about the shocking history of revolutionary boiler that bits all records](#).

## **#E8. The amphora from Pakistan:**

At this point I should remind, that the situation created by the heater described here already existed once on the Earth. During my professorship in Cyprus told me this story my student from Pakistan, in whose family town this situation took place. Namely, since unknown times until 1950s in Pakistan a metal amphora did exist. It lied for several centuries in a stream that flowed through one of palaces in that country. This amphora continually boiled water which washed it, without consuming any energy. Unfortunately it was destroyed by an English scientist in 1950s, who in the name of science convinced the local landlord to see what is inside of it. The scientist cut it apart. It turned out to be empty inside. However, later he was unable to put it back together to make it work. The description of this "amphora from Pakistan" is provided in item #B2 of the web page [newzealand.htm - about mysteries and curiosities of New Zealand](#), and also in item #E4.2 of the web page [boiler.htm - about the shocking history of revolutionary boiler that bits all records](#). In turn the principle of operation of this amphora from Pakistan is explained by phenomena described in subsection H6.1.3 from volume 4 of [monograph \[1/5\]](#). According to my estimates, this principle was almost identical to the principle of operation of the telekinetic heater described on this web page. Only that surfaces of it washed up by hot and cool water were additionally looped through the oscillatory circuit with the resonating electrodes of it. Therefore the hot and cold water which washed these surfaces released the action of so-called Seebeck Effect, thus generating on these surfaces electric charges which were needed to supply this amphora in energy required to its operation.

---

## **Part #F: Generators of mechanical free energy (i.e. energy which takes the form of rotational motion):**



# #F1. There is a philosophical justification that "perpetual motion" devices can be build and actually are going to work:

The philosophy of totalizm states, that there are significant "discrepancies" between conclusions derived from philosophical analyses, and some so-called "laws" of physical sciences. If the essence of these discrepancies could be proven correct for findings of philosophy, then this could cause a kind of revolution in Sciences, Engineering, and in real life. Let's provide here a specific example of such a discrepancy, which in my opinion could be verified experimentally - e.g. could be proven or disproved with an experiment. Namely, from the philosophical point of view, the only difference between e.g. a "windmill" and a "perpetual motion device", is the length of time in which the propelling medium provides a steady energy supply to a given device. So if there exists a "wind" which blows continually, steadily, and strongly for, let's say, one million years, then the "windmill" which such a "wind" would propel, would become a "perpetual motion device". Thus, from the point of view of any philosophy, "perpetual motion devices" can be build - if we find a propelling medium (e.g. a "wind") which provides a steady energy supply continually for thousands of years. But the discipline of thermodynamics claims the exact opposite. It states that "perpetual motion devices cannot work" at all, as their operation supposedly would run against the statistic predictions which carry the name of "laws of thermodynamics". So it would be an interesting situation if philosophy proves to thermodynamics that so-called "laws of thermodynamics" are still incomplete because were NOT consulted with philosophy. After all, various sciences know "winds" that "blow" continually and steadily for millions of years. To indicate here some examples of such "winds", these include: the rotation of our planet Earth, the motion of Moon around the Earth, the magnetic field of the Earth, waves of a "cosmic noise", various behaviours of elementary particles, and many more. So if, for example, we construct a "flywheel", which meets following easy-to-fulfil conditions: (1) it has the so-called "momentum of inertia" larger than its "friction torque", (2) it is perfectly balanced - so that the gravitational field of the Earth does NOT influence its angular orientation, and (3) it is so assembled in a given location that the axis of rotation of this flywheel is exactly parallel to the axis of the Earth's rotation; then such a flywheel should create an everlasting motion in relationship to the Earth, with the speed of one rotation per day (or more strictly, this flywheel would remain motionless in relationship to our solar system, while the Earth would rotate around it once per each day). So such a flywheel - if constructed and provided with an appropriate gearbox linked to a pointer, could prove empirically that philosophical principles are more advanced than so-called "laws of thermodynamics". This in turn would have enormous implications for all areas of science and technology. For example, it would provide the society with a rather illustrative example that philosophy still remains the "mother of all sciences", and thus it would increase the rate of employment of graduates of philosophy in all areas of science and engineering. It would be a perfect "bridge" that would facilitate cooperation between Philosophy and Sciences or Engineering. It would also change our entire civilisation, as it would pave the way for the development of various principles that would allow to draw free energy and everlasting motion from various perpetual "winds". In turn implementation of these principles would allow the humanity to generate energy without any consumption of fuels (and thus also without causing pollution) from phenomena which currently no scientist have a courage to investigate because these run at the collision course with "laws of thermodynamics".

## #F2. So let us verify the philosophical premises by building a flywheel that operates as a mechanical "perpetual motion" device which rotates infinitively on principles of the so-called "Coriolis effect":

The philosophical premises described above indicate that the everlasting rotation of the Earth represents a kind of "wind" that could propel a "perpetual motion" device. Therefore if an excellently balanced heavy flywheel with good bearings is positioned so that its axis of rotation is parallel to the axis of the Earth's rotation, then the Earth is to revolve in relation to this flywheel, while the so-called "Coriolis effect" is to maintain the flywheel in a motionless position in relation to the rest of the universe (e.g. in relation to the entire Solar system). In the result, for a witness who stands on the Earth next to this flywheel, the wheel is going to behave like a "perpetual motion" device which makes one revolution per each day (or a revolution by 15 degrees each hour). Thus, if someone places a marker on the circumference of such a flywheel, then its perpetual rotations can be noticed visually even without the use of any gearbox which would multiply the speed of its slow rotational motion. This flywheel is also able to generate a small amount of the thrust torque. This thrust torque is equal to the momentum of inertia of the wheel itself, minus the momentum of friction on its bearings, and minus the drag momentum caused by imperfections in the gravitational balancing of the flywheel and in positioning of the axis of rotation perpendicularly to the Earth's axis of rotation. Thus, the thrust torque that is generated by this flywheel is able to generate small amount of useful energy, e.g. small amount of electricity.

Such a heavy flywheel with good bearings is to constitute a most simple for constructing, although highly illustrative kind of perpetual motion (PM) device that generates mechanical energy in the form of everlasting rotational movement. As such, it is going to have an immense historical significance. It will also generate a breakthrough in the human thinking about generators of free energy and about ideas of "perpetual motion". After all, it will prove that both, such generators of free energy, as well as perpetual motion devices, are possible to be build after all, and in fact they generate energy completely for free. In this way the flywheel is going to disclose the intentional misleading hidden behind claims of the official human science that such devices can never be build.

In 2004 I visited a tower from the Basilica in Frombork (Poland). This tower is famous because it was in it that the Polish astronomical genius, Mikołaj Kopernik (Nicolas Copernicus) used to work. During the time of my visit, this tower was turned into a museum of the physical-astronomical character. An exhibit from this museum that especially attracted my attention was a massive pendulum which illustrated the action of so-called "Coriolis effect". Namely, the pendulum was made to swing infinitively. However, apart from the swinging motion, it also displayed the rotary motion. The rotational velocity of this rotary motion amounted to just one rotation per day. In order to sustain its swinging, the pendulum was continually supplied with energy impulses. But it did NOT receive any energy to sustain its rotary motion. This means, that the rotary motion was sustained by the energy that it received from the "Coriolis effect". In other words, that pendulum from the tower in the Frombork's Basilica was a first prototype that illustrated the principle of the perpetually rotating flywheel described here. Only that, because this pendulum carried out two kinds of motion simultaneously, it make impossible the interception of energy from it, that was supplied by the Coriolis effect. But the flywheel described here makes possible, and even

easy, the interception of this energy. Also the flywheel does NOT require any energy supply. Thus in fact it is a good example of a so-called "perpetual motion" (PM) device.

On the basis of that pendulum from Frombork, which rotated continually just by itself upon the action of the Coriolis effect, already now we can conclude, that the mechanical "perpetual motion" (PM) described here must also work in practice. After all, the action of the Coriolis effect is confirmed on countless number of cases, not just only on the case of that pendulum from Frombork. Unfortunately, the PM described here is not much useful in practice as a source of free energy, because of its small thrust torque and highly awkward rotational velocity that amounts to just a single rotation per day. (The thrust torque of the flywheel described here is relatively small, because equal to just a momentum of inertia of it, minus the momentum of friction on its bearings, and minus the breaking momentum which originates from imperfections in the balancing and in the precision of pointing the axis of rotation.) However, in spite of its small practical usefulness, this flywheel still is worth of building, because of its awareness, psychological, educational, and inspirational values.

### **#F3. The significance of the mechanical perpetual motion as a breakthrough illustration that causes a revolution in views, knowledge, and emotional attitudes of witnesses:**

Of course, as every other "perpetual motion" device, such a flywheel rotated by the action of the Coriolis effect will have a huge value as a technological curiosity and as an illustration for the correctness of the idea for this kind of devices. After all, its everlasting rotations by 15 degrees each hour, and by 1 rotation each day, will prove to everyone who is to see it, that perpetual motion devices can be build after all, and that our science to date, as usual, also this time was at wrong when it declared categorically that such devices will NEVER work.

Just for this reason I personally suggested that such a perpetually rotating flywheel is installed in the future **museum of free and renewable energy in Wszewilki** (or in Milicz). The organising such a museum I am lobbying inhabitants of these settlements for quite a time. My proposals as to what generators of free energy should be exhibited in such a museum from Wszewilki, are described in item #F4.1 from the update of the web page [\*\*wszewilki jutra uk.htm - about dreams of better future for the village of Wszewilki\*\*](#) dated 27 February 2008, or later.

The usefulness of the flywheel described here as a highly educational exhibit for any possible museum, is also increased by the fact, that this flywheel can be build by local tradesmen for practically every museum. Thus, with a bit of local patriotism, such a flywheel can be completed in there either completely free of charge as the altruistic deed of local tradesmen, or just for a small cost that would cover prices of materials.

### **#F4. How to build the perpetually rotating**

## flywheel described here:

The construction of the perpetually rotating flywheel described here is relatively simple. It suffices to recover from a junkyard an old flywheel together with the permanent axel to which it is attached, or retrieve any heavy wheel (with an axel) that is well balanced - e.g. a large railway wheel. Then this flywheel needs to be supplied in good bearings so that its axel is parallel to the axis of Earth's rotation. For this, the axis of its rotation should be positioned exactly along the line of geographical south-north, and also this axis should be slanted vertically by the angle that is equal to the geographical latitude of the place in which this flywheel is to be assembled. For example, for such flywheels assembled on the territory of Poland, the angle of their slanting towards horizontal should amount somewhere between 49 and 55 degrees - depending on the exact location of the place in which someone is going to build it. After it is assembled, the flywheel needs to be checked for its precise balancing in the angular positioning, and for the easiness of its rotations. If it is balanced precisely and easily rotating, any marking made on its circumference is going to indicate that this flywheel in fact does rotate all by itself by one rotation per each full day.

For a better illustration of the actual rotations of the flywheel described here, the axel that rotates together with it can be coupled with a multiplying gearbox for a "flywheel pointer". The function of such a multiplying gearbox can be performed by a mechanism that is dismantled from an old and unused clock. This is because mechanisms of such old clocks frequently were constructed for the gear ratio 1:1440 ( $1440 = 24 \times 60$ ). Thus, when a single rotation per day is supplied at the input to the multiplying gearbox with such a ratio, then one rotation per minute is received at the exit from it. This means that the "flywheel pointer" (preferably of a large size) attached to the exit from such a multiplying gearbox, is going to rotate with the speed clearly noticeable to human eyes. The rotational velocity of such a "flywheel pointer" would be equal to the speed with which in present watches rotates the pointer of seconds.

Of course, the biggest challenge for the builders of such flywheel would be to transform it into an electricity generator. After all, in order to be able to operate as an electricity generator, it needs to be supplied into a gearbox which its just one revolution per day would multiply into some useful rotations which would be able to generate electricity. Fortunately, this challenge is purely theoretical, as the energy efficiency of such a single flywheel is so small, that it is NOT worth of effort to turn it into an energy generator. Thus such a change into an electricity generator would only have a value as a proof which documents to everyone that this flywheel is in fact able to generate free electricity - in spite that the official human science claimed categorically that such generation of free electricity is absolutely impossible. But the amount of electricity that it would generate in practice would be too small in order to justify its practical application for an industrial scale. However, the illustrative proving that this flywheel generates some free electricity after all, would have an inspiring value. This is because it would motivate people to seek other principles of operation for perpetual motion devices, which would be able to generate much higher amounts of electrical energy.

In order to enable such a perpetually rotating flywheel to propel a small generator of electricity, a large multiplying gearbox would need to be coupled with the axel of it. This gearbox would need to multiply one rotation per day of the flywheel, into at least one rotation per second of the rotor of the electricity generator. This means that such a gearbox would need to have the multiplying gear ratio of at least 1:86400. This in turn means, that if such a multiplying gearbox is based on mechanical principles of operation - as this was done in old clocks, then only its losses for friction would consume an entire thrust torque generated by the flywheel. Also in practice such a gearbox would typically self-jam and thus it would be unable to carry out the motion because of its inner friction. In turn a possible hydraulic device would have larger leaks than the output from the pumping efficiency generated by the motion of this flywheel.

To summarise, although as a useful source of free energy, the single flywheel working in the way described above is rather of no much use. However, in my opinion it still has a revolutionary significance. After all, it illustratively proves that in fact there are principles of operation which are able to supply perpetual motion to people for free. Thus the flywheel constitutes a visual proof for the correctness of the idea of perpetual motion devices. Furthermore, it supplies a starting device for future working out the entire systems of such flywheels which are to yield energy more efficiently. As such, the single flywheel described here has immense significance as a historical and museum curiosity, as a teaching aid, as a source of inspiration which is to drive further searches for more useful principles of operation for perpetual motion devices, and as a breakthrough in our thinking.

## **#F5. Why the perpetually rotating flywheel described here was NOT invented accidentally already a long time ago:**

In order the flywheel described here works as a perpetual motion device, its axis of rotation **must** be exactly parallel to the axis of rotation of the Earth. This requirement, although very elementary, in fact make impossible an accidental invention of this flywheel. After all, practically almost all flywheels which people constructed so-far, have their axes of rotation positioned horizontally. So in spite that people built many of such flywheels already in the first stage of implementation of steam and combustion engines, in fact almost none of them worked in the positioning that would convert it into a perpetual motion device. After all, in order any of these flywheels with a horizontal axis of rotation worked as a perpetual motion device, it would need to be located exactly on the equator of the Earth, and its axis of rotation would need to be pointed exactly along the line south-north. However, along the Earth's equator almost NO civilisation centres are located in which first steam or combustion engines with flywheels would be placed. So users of these first engines had NO opportunity to accidentally witness work of such flywheels as perpetual motion devices. Thus in fact humanity never obtained a chance for an accidental discovery that flywheels can work as perpetual motion devices.

## **#F6. An entire system of flywheels - means how to improve the principle of the perpetually rotating single flywheel described above, to increase its energy yield:**

In item #B1.2 of this web page it was explained, that in order "perpetual motion" devices can be transformed into generators of free energy, one needs to form in them the "energy feedback loop". This feedback would loop a part of energy which they generate at the exit, feeding this energy back into their entrance, thus "multiplying" their entire energy yield. In a single flywheel described before the formation of such a feedback is impossible.

But if one combines together an entire system of such flywheels, which is to contain several of them, then the "energy feedback loop" can be accomplished in this system. Let us now consider how this can be achieved.

The momentum of inertia is a first quantity which allows us to form easily the "energy feedback loop" in a larger system of flywheels similar to the flywheel described before. In turn, as we know from item #F2 above, this momentum of inertia influences linearly the amount of energy generated by a given flywheel or by a given system of flywheels. Means, the higher the momentum of inertia, the more free energy one is able to harvest from it. In turn the increase the momentum of inertia can be accomplished on two different manners. One of these manners depends on the increase of the mass of a given flywheel - and this is rather a clumsy manner. After all, in order to generate a reasonable amount of useful free energy such a flywheel would need to be massive and weight many tons. Another, more "elegant" manner of the increase of its momentum of inertia depends on the use of so-called "gyroscopic effect". In turn this effect is to increase the momentum of inertia of the flywheel discussed here, if this flywheel instead of being constructed as a single massive wheel, is rather build in a segmented manner as a system of several smaller flywheels which mutually increase their rotational velocity. (We must remember that in fact the Earth rotates in relation to these wheels, not these wheels rotate in relation to the Earth.) Of course, such a gyroscopic system still must be perfectly balanced, so that it will NOT form a gravitational momentum of resistance. What even interesting, with such a segmental design of the well-balanced flywheel described here, the rotational velocity of its composite wheels (the ones which generate the gyroscopic effect) can be forwarded to their input through the energy feedback loop from their output. Thus such a systems will "multiply" by itself the energy that it is to generate.

Another quantity which could also make it possible to form "energy feedback loop" in the entire system of flywheels, is the capability to intercept the Coriolis effect during the rotations. Namely, the behaviour of water in fast rivers suggests that the Coriolis effect is able to act on flywheels that already rotate. (Of course, whether in reality this happens, it is going to be revealed by experiments after constructing first such flywheels.) This practically means, that several flywheels could be coupled together into cascades via coupling gears. In these cascades, the first flywheel, which would be the flywheel described before - that revolves once per day, would propel via a coupling gear a next flywheel that would rotate much faster, but still would intercept the Coriolis effect, and this one in turn would propel still another flywheel via a coupling gear, etc., etc. In the result, the last flywheel in this cascade, would already have the rotational velocity able to propel effectively an electricity generator, while the thrust momentum of it would be equal to the sum of thrust momentums of all flywheels of the cascade. Thus, such a cascade would provide the velocity feedback loop. Means it would make possible to harvest the output velocity from a first flywheel and feed it as an input velocity of a next flywheel.

If the Coriolis effect allows to form such cascades of flywheels with growing rotational velocities, then also the nature of these coupling gears between subsequent flywheels is to change. Namely, when there is only a single flywheel, the gear which feeds its rotations onto an electricity generator would be a so-called **multiplying** gear. In turn, as this is explained above in item #F4, such multiplying gears have their upper threshold limit of ratio for which the internal friction begins to cause them getting jammed. Therefore, e.g. the ratio 1:86400 would be technically very difficult to accomplish in multiplying gears. However, when we deal with two flywheels, each one of which is self-propelled by the Coriolis effect, then the coupling gear which regulates their mutual rotations looses its character of a multiplying gear. Thus the ratio of it can be of any large value (even która reguluje ich wzajemne prędkości traci swój larger than 1:86400), and the coupling gear is still going to work without getting self-jammed. Therefore in such a cascade of self-propelling flywheels, the rotational velocity at the exit which become capable of an effective propelling of an electricity generator, probably can be accomplish already in cascades composed of just two or three flywheels.

To summarise these deductions, the actual building the perpetually rotating flywheel described before would only be a beginning, not the conclusion. This is because such building creates opportunity to learn attributes and behaviours of such flywheels - as NO one researched these characteristics. In turn this learning opens a possibility to build entire systems of such flywheels, which systems can be subjected to further improvements that are to increase their energy yields. Thus the second step after the first such flywheel is build, is to redesign it into e.g. a gyroscopic system and a cascade system. Such a system is to be composed of several well-balanced flywheels, the rotation of which would propel itself, and which would mutually increase their momentum of inertia and their rotational velocity (and thus also their energy yield). What even more interesting, these increasingly faster spinning componential flywheels could be designed in such a manner that they would constitute rotors of electricity generators. In this manner it would become possible to increase the energy yield of the "perpetual motion" principle described here, and perhaps even transform this principle into a principle of technically viable generator of free energy.

---

## **Part #G: A "car on water" - still further example of other kinds and principles of free energy generators:**

### **#G1. Telekinetic dissociators of water into oxygen and hydrogen to become main components of the "engines on water":**

Our civilisation developed technically quite perfect form of propelling device, which is present combustion engine. In spite that people are trying to replace it with other propelling devices, all these other devices always contain various disadvantages which make them significantly inferior in comparison to the combustion engine. However, a single problem which this combustion engine has, is the kind of fuels that it presently uses. After all, when it burns present fossil fuels, it produces undesirable combustion gases which pollute the Earth's atmosphere. Furthermore, deposits of fossil fuels are close to the exhaustion on the Earth. But if in this engine we replace the fossil fuels which are currently used, with a mixture of hydrogen and air (which is equally safe as the present mixture of petrol and air), then the same combustion engine rapidly ceases to has the problem. Then it works equally effectively and reliably as at present, but simultaneously instead of undesirable combustion gases it emits just ordinary water vapours. Therefore, the major challenge which our civilisation has, is to change gradually the to-date "engine on petrol" into the futuristic **engine on water**.

The major difficulty with such adoption of combustion engines for fuel in the form of mixture of hydrogen and the air depends on effective production of hydrogen at the inlets to these engines. This problem is solved by so-called "telekinetic dissociators of water" described, amongst others, in subsection LA3.2 from volume 10 of [monograph \[1/5\]](#). Their principle of operation is very similar to the operation of "telekinetic heaters" described on the web page [boiler.htm - about the shocking history of telekinetic heater which bits all records](#), while summarised here in "part #E" of this web page. The main difference

between such **telekinetic dissociators of water** and "telekinetic heaters" boils down to the use of different frequency of vibrations and also different catalysers (materials). For example, the frequency of vibrations which cause the dissociation of water into hydrogen and oxygen must be identical to the own resonance frequency of particles of water. In turn the catalyser used must spontaneously neutralise the electrical charges of both gases to allow them exist as separate gases. The phenomenon of telekinesis utilised in the principle of operation of such "telekinetic dissociators of water" allows them to accomplish the energy efficiency that significantly exceeds 100%. In turn such high energy efficiency causes that the telekinetic dissociation of water uses significantly less energy to produce hydrogen, than the energy that is generated by the engine which burns this hydrogen. Thus, the future "engines on water" discussed here are going to self-supply into energy their own dissociators of water, without requiring any other energy nor fuel apart from just a pure water. The development and manufacturing of such telekinetic dissociators of water which are to replace present carburettors from combustion engines e.g. in our cars, is going to lead to the situation that in the future all combustion engines will burn exclusively water, which these engines will decompose just by themselves into hydrogen and oxygen. (For safety reason only hydrogen is to be used, while oxygen is to be let out to the air. The attempt to burn also oxygen would introduce a fire-threat.) In turn exhaust gases from this burning will be just water vapour (steam). (I suggested that the development of production of such telekinetic dissociators of water to be undertaken one day in my native village Wszewilki - see descriptions from item #C4.5 of the web page [wszewilki jutra uk.htm](#).)

Many people believes that is it not worth to invest into the transformation of present combustion engines into engines that burn a mixture of hydrogen and the air. They believe that it is much better for our civilization to get rid of combustion engines all together and replace them with electric motors. Although such complete replacement of combustion engines may sound realistic and attractive, there are going to be numerous situations on Earth, when it turns out impossible. As examples consider tradition, bobbies, or sport - although there are also countless other reasons at work. In future it will be impossible to forbid people who cultivate a tradition of hobby which requires combustion engines, or who practice a motor sport, to remove completely combustion engines from whatever is the essence of their tradition, hobby or sport. After all, if for example someone wishes in the future to enjoy for a hobby the present motorbike "Harley-Davidson" (and I am ready to bet that there is going to be many such people), then it will be impossible to do so after replacing in it the combustion engine with an electric motor. After all, whatever would be received then would NOT be a "Harley-Davidson" any more. But then it is possible and feasible to replace in this motorbike the presently used fuel by a mixture of hydrogen and the air. In turn, after such a replacement of the fuel, and after the introduction of slight technical changes which this replacement would require, what would be obtained still would have all attributes of the motorbike "Harley-Davidson". Of course, this motorbike is indicated here as an example. In the future everything that presently uses a combustion engine, a jet engine, or a rocket propulsion, can be used in the same manner as today only after a small conversion to allow in engines use the mixture of hydrogen with the air for fuel while in rockets use the mixture of hydrogen with oxygen. In turn such a conversion will require only the replacement of present carburettors with "telekinetic dissociators of water" described here, while for petrol just water will be stored in their tanks. The entire rest of their design, principles of operation, manners of work, controllability, engine longevity, validity of designs, theories and research, technical improvements, culture, human habits, etc., etc., will then remain without any changes.

"Engines on water", which are to generate the fuel by themselves through the telekinetic dissociation of water, will display a whole range of extraordinary benefits. Also all these benefits become passed onto machines which use these engines, for example onto the future "cars on water". Let us list here the most vital amongst these benefits:

(1) These engines will be incomparably more safe than present combustions engines which



use e.g. petrol. After all, otherwise than this in present engines which need tanks with flammable fuel, these "engines on water" will just have storages of inflammable water. The flammable fuel they will generate just a short while before it is to be burned and only in the required (small) quantities at once. Thus such "engines on water" will NOT be able to ignite nor initiate a fire or an explosion of themselves nor e.g. a whole car - as we frequently see this happening with our present engines. Also the hydrogen-air mixture that they are to burn is much safer than the present mixture of the petrol with the air, because it is difficult to ignite, while in case of leakages it is to simply escape into the air instead of spilling over the engine.

(2) These engines will be extremely inexpensive in exploitation. After all their fuel is to be just an ordinary water the huge reserves of which we have all over the Earth. This water is going to be telekinetically dissociated by them (with the efficiency of over 100%) into hydrogen and oxygen by the excess of energy which these engines will generate through the burning of hydrogen.

(3) These engines are NOT going to generate any air pollution. After all, from their exhaust pipes just water vapour (steam) is going to escape.

(4) All to-date accomplishments of the humanity in the area of building combustion engines remain valid for them. Thus everything that the humanity knows on the subject of increasing their longevity, perfection of work, scientific foundations, experiences in design and building, maintenance, use, etc., is to remain valid for them.

(5) These engines are NOT going to outbalance the nature. After all, their fuel is to originate from the dissociation of water, while their products of work simply are to restore this water. Furthermore, to supply them into fuel, the humanity does NOT need mines nor oil refineries.

## #G2. The present level of development of a "car on water" - means the use of hydrogen from the process of dissociation of water for increasing the efficiency of fuel burning:

For quite some time in Internet and in literature the idea of so-called "car on water" is being developed. *This name **can on water** means a modified car in which the burning of mixture of petrol with the air is going to be replaced gradually by the burning of the mixture of hydrogen with oxygen obtained in the same car with the use of process of telekinetic dissociation of pure water into hydrogen and oxygen.* Thus in such a "car on water", a pure water is to be used for a fuel, while from the exhaust pipe of it the water vapour (steam) is going to escape. Of course, as everything in this physical world, such a "car on water" is constructed gradually. In this item I am going to describe the present level of its development, in the state on 13 June 2008, when in New Zealand television was shown a model of this car build by two young hobbyists from New Zealand.

On Friday, 13 June 2008 at 7:00 pm to 7:30 pm on channel 3 of the New Zealand television, in a programme called "Campbell Live", a report (news item) was broadcasted about two young hobbyists from New Zealand, who constructed for themselves the present version of the "car on water". These two hobbyists simply modified an old model of the car that they had (probably it was "Ford Falcon"), so that they implemented in it the present level of technology of the "car on water". I personally was NOT interested in this programme in the technology that they used, as this technology is described in Internet and in literature

already for many years, but in **savings of fuel burned** that were measured in their modification. Namely, in the television programme discussed here fuel consumptions were compared for two identical cars of the same model and the same age (and even the same colour). One amongst these two cars was just that "car on water" modified by these two hobbyists. In turn the other one was an almost identical to it car of the same model and year of production, but NOT modified (i.e. just in the original factory design). In both these cars simultaneously the television crews drove along 100 kilometres road with exactly the same speeds, then they measured the fuel consumptions in both of them. It turned out that the "car on water" of these young hobbyists burned only around 5 litres of petrol. In turn the non-modified car burned over 20 litres of petrol. This in turn means that small modifications that are required for constructing the present technology of "cars on water" in this particular case decreased the fuel consumption to only 25% (one fourth, or a quarter) of the original fuel consumption.

It is easy to work out that the saving on fuel in the car which was modified by these young hobbyists could be non-typically high. After all, these hobbyists modified one amongst American "gas-guzzlers". These in turn are widely known in the world from a wasteful burning of fuel. So if someone modifies in the same manner a present efficient car of e.g. Japanese or Korean production, then probably will NOT get such spectacular results. On the other hand, the dissociator of water used by these hobbyists worked on conventional principle. So if in stead of this conventional principle, the telekinetic dissociator of water is used with the energy efficiency of over 100% (as described in item #G1 above), then the savings on fuel should be high for practically every car. Also, as the principles of operation of such telekinetic dissociators of water are going to be improved, in such cars probably the complete elimination of burning the fuel other than water can be gradually accomplished.

In this television programme explained was also the modification of the car that was utilised by these young hobbyists. It turned out that this modification was very simple and based on present technology of dissociation of water into hydrogen and oxygen. It boiled down to adding a small dissociator of water to a typical car engine that burns petrol (i.e. non-modified engine). This dissociator of water consumed the electricity that was generated by the car's dynamo to dissociate water into hydrogen and oxygen. Then hydrogen was mixed with the air that was supplied to the carburettor of that car. Thus, instead of burning only the mixture of petrol and air, this particular car burned the mixture of petrol, air, and the hydrogen gas. In the result of burning such a mixture, the temperature of burning in the car's cylinder was increased significantly. In addition, the hydrogen-air flame which this mixture formed in the cylinder, performed a function of a dynamic "catalyser" which improved the dynamics of the burning of mixture of fuel and the air. In turn, this increase of the temperature during burning the mixture of petrol-air-hydrogen, together with the catalysing ability of the hydrogen flame (a) increased many folds the efficiency of burning the fuel, (b) enhanced the performance of the engine, and (c) it additionally eliminated the smoke from fumes almost completely. Thus, this car burned petrol so effectively, that instead of smoke that typically escapes from the exhaust pipes in normal cars, in this car from the exhaust pipe escaped only transparent carbon dioxide and equally transparent water vapour (steam). So in spite that in this car the dissociation of water was carried out in a classical manner (i.e. without the use of telekinesis) and at the cost of burning petrol, still the hydrogen produced as the outcome of this dissociation, so effectively increased the temperature and efficiency of fuel burning, that it decreased the fuel consumption by almost 75%. This car consumed also around 1 litre of water per 100 kilometres. The only improvement that these two hobbyists added to the already described in internet technology of constructing such "cars on water", was a special breaker system (safety vent) which prevented the ignition of hydrogen in cases if the car "sneezed to its carburettor".

Unfortunately, this particular prototype of the "car on water" was shown in television. Thus many details that are worth to learn were NOT provided in there. Also in spite that the channel 3 of the New Zealand television has two web pages, i.e. [www.tv3.co.nz](http://www.tv3.co.nz) and

[www.3news.co.nz](http://www.3news.co.nz), on none of these I could find anything about this "car on water", or about its hobby constructors. However, **I will seek further data either about these young hobbyists and their modification, or about other prototypes of "cars on water"**. In turn when I find something worth reporting here (e.g. further descriptions of such modifications of a specific car, the specifications of which I can verify in person as true ones, or contact details to real people who implemented such modifications), I am going to describe it here.

The television programme reported above was one of these rare exceptions, when instead of just showing problems, for change the television provided an example of solution to a problem. For this reason the programme got a huge response amongst hobbyists of New Zealand. In the result many people who had conditions for "doing it yourself", implemented in their own cars the solution of the "car on water" shown in this program. Therefore on Monday, 23 June 2008, at 7:00 to 7:10 pm on the same channel TV3, a follow up continuation of this tv programme was broadcasted. Amongst others, another New Zealand hobbyist demonstrated in it his own construction of a "dissociator of water" which he used in his "car on water". His dissociator was extremely simple. It did NOT separate hydrogen from oxygen, nor it vented the oxygen into the air. (Such a separation and venting typically is done in "cars on water" for safety reasons - to prevent a self-ignition and fire.) It supplied to the carburettor both these gases mixed together. Because this mixture of gases threatens to self-ignite, in order to eliminate the danger of a fire he was using additional "water vent". This hobbyist claimed that the construction of the entire installation of his "car on water" cost him only around 50 dollars. His "dissociator of water" was made of a 1 litre glass jar into which he poured a litre of water with the addition of a table spoon of "baking soda" (this baking soda is to intensify the process of dissociation of water). In the water of this jar two electrodes connected to the battery were submerged. After starting the engine these electrodes dissociated water into a gaseous mixture of hydrogen and oxygen. The mixture gathered at the top of the jar, from where it was supplied by a plastic pipe to the "water vent", and then to the inlet of cylinders. His "water vent" was also very simple. It was a small bottle left from cream, full of water, in which the gaseous mixture needed to bubble through the water. So in case of an accidental ignition of the mixture of hydrogen and oxygen, the flame would be cut off on this water. The hobbyist claimed that just such a "water vent" suffices for the prevention of a fire, as his installation generates only as much of the flammable mixture as was immediately used up.

The main reason why it is worth to advance technologies of "cars on water", is that the gradual mastery of the telekinetic dissociation of water which gives the efficiency of over 100% (described in item #G1 above) one day will allow to accomplish a breakthrough. Namely it will allow to eliminate completely the fuel burning in cars in the future. It is going to gradually turn cars into kinds of self-propelling generators of free energy which burn exclusively pure water that they dissociate telekinetically themselves into hydrogen and oxygen. Therefore the version of the "car on water" described here is the first step towards such a breakthrough. The second step will come when the conventional dissociator of water will become replaced by the telekinetic dissociator of above 100% efficiency. This telekinetic dissociator will supply additionally the cylinder into the mixture of hydrogen with the air, similarly as this is done in the car on water described here. In turn the third, final step towards the breakthrough will be when the burning of petrol will be completely eliminated and replaced with the burning of just the mixture of the air and hydrogen. Coincidentally, during writing this paragraph the Japanese Honda come to the market with the new car the engine of which burns exclusively the mixture of the air and hydrogen (only that the hydrogen is NOT generated in the car as it is needed, but accumulated in the tank instead of the fuel - thus unfortunately increasing the threat of starting a fire and explosion). The description of this Japanese car is in the article "Zero emission car in production" from page C5 of the New Zealand newspaper [The Dominion Post](#), issue dated on Wednesday, June 18, 2008.

## **#G3. Guidelines for building "cars on water" and other "zero emission cars" described on this web page, are provided on the separate totaliztic web page [eco cars.htm - about the design and principles of operation of zero emission cars of the future:](#)**

In order to build a car that is in 100% fuelled by water, an effort of a large research and development team is necessary, not just skills of a single scientist. However, in order such a team could be formed and accomplishing a success, the goal for its action is needed, and also a general direction of the path which is to lead to accomplishing this goal. These in turn are explained on the separate web page [eco cars.htm - about the design and principles of operation of zero emission cars of the future.](#) That other web page NOT only describes the present state of technology of "cars on water", including guidelines as how to "do it yourself" when you convert your own "gas-guzzler" into a "car on water" described above in item #G2. That other web page describes also several other feasible and already proven correct designs and principles of operation for highly economical zero emission cars of our future. That other web page even describes the **accumulator of energy for cars (i.e. a car battery)**, for the invention of which **Senator McCain promises the award of 300 millions of USA dollars.**

---

## **Part #H: The "curse of inventors" - means a secretive persecutions of inventors, scientists, and all other creative people who further the "real progress" of humanity:**

### **#H1. Where from comes this mysterious persecution of inventors and researchers of free energy generators:**

When analysing biographies of inventors it is not difficult to notice a strange trend.

Namely, whenever a new device is invented and build on the Earth, and it introduces a "real progress" to the humanity - as such a "real progress" is defined in item #G4 of the web page named [eco cars.htm](#), then immediately a sort of "**curse of inventors**" is unleashed. This curse soon squashes either the device or the inventor. Only on this web page three immensely important inventions are described, i.e. three devices of "free energy", all of which were suppressed by this "curse of inventors". Further similar cases are described in item #G2 of the totaliztic web page [eco cars.htm - about pollution-free cars](#), in item #H1 of the totaliztic web page [newzealand visit.htm - about mysteries and curiosities of Antipodes](#), in item #K3 of the web page [fe cell.htm - about telekinetic cells](#), in items #D1 and #F1 of the web page [boiler.htm - about the shocking fate of telekinetic heater which bits all records](#), in item #B4.4 and on the entire rest of the web page [mozajski uk.htm - about Aleksander Mořajski, the Polish inventor and builder of the first flying airplane in the world](#), as well as in subsection W4 from volume 18 of [monograph \[1/5\]](#). Other similar cases are described practically in every book which presents the biography of any inventor who developed something that fulfils that definition of a "real progress" - explained in item #G4 from the web page named [eco cars.htm](#).

The action of this "curse of inventors" squashing inventions is a rule - no matter in which country a given invention is accomplished. It works in practically every country and every nation. Only that the force with which it persecutes a given inventor depends on the level of escalation of immorality amongst inhabitants of that nation and country. This is why in some countries with especially high escalation of immorality, inventors are unable to introduce into life even a single invention that furthers the "real progress" - as such "real progress" is defined in item #G4 from the web page [eco cars.htm](#). Therefore, these **most immoral countries and nations suffer the "inventive impotency" described, amongst others, in item #B7 of the web page seismograph.htm**. This "cures of inventors" causes also, that an inventor of practically every invention which fulfils the definition of the "real progress", is with some force persistently persecuted, abused, punished, cheated, make poor, etc., by his own countrymen. Also, almost every such inventor dies in obscurity forgotten by everyone - sometimes in spite that on his invention other people make millions. These persecutions of true "progress makers" are so common and so "unjust", that I call these persecutions the **curse of inventors**. My explanation why this "curse of inventors" acts so destructively and with such an "iron hand", is described in web pages indicated before, e.g. in item #B4.4 from the web page named [mozajski uk.htm](#), in item #G3 from the web page [eco cars.htm](#), etc.

In order to summarise in just a few words reasons described in there for the existence and for the operation of this curse, then these would read: **the "curse of inventors" is actually a kind of "moral mechanism" which prevents the most immoral communities and nations from drawing benefits out of new inventions and discoveries, and thus which makes sure that immoral communities and nations are "punished" due to the induction in them the so-called "inventive impotency"**. Expressing this in other words, the "cures of inventors" is a kind of "moral mechanism" which makes sure that new breakthrough inventions and discoveries are implemented only by the communities and nations which deserved the "reward" of gaining these because they behaved in a much more moral manner than all other communities and nations on the Earth.

Many people do NOT believe in the existence and action of this "curse of inventors". They ignore it in spite that there are too many cases like this, taking place in too many countries, to be just a coincident. The reason for this rejection and ignoring probably is that the work of this curse cannot be explained without acknowledging the fact that on the Earth must exist and act some "supernatural power which organises this curse and which executes every case of its work. But even if one does not share my views, still just by just looking at the sheer volume of inventions that are strangely being hold back, suppressed, or destroyed, one must admit that something really weird is going on, and that something or someone is intentionally suppressing the development of "progress carrying devices (e.g. free energy devices) on the Earth.

## #H2. The fate of nations and the entire humanity follows the way we treat creative inventors and discoverers (NOT e.g. how we treat artists or movie stars):

*Motto: "What we punish and scoff we will have increasingly less, what we reward and prize we will have increasingly more." (Ironically, our civilisation punishes and scoffs e.g. creation of inventions and new technical ideas, while it rewards and prizes e.g. public manifestations of idleness and immoral behaviour.)*

Unfortunately, opposite to whatever we are being told in schools, actually the real fate of humanity does NOT depend on artists, means on musicians, singers, actors, movie stars, painters, writers, etc. God is well aware of this fact, because He does NOT trouble artists with the so-called "**curse of inventors**" described below in item #H4. God also does NOT require from creative artists to be "pedantically moral" before He allows them to create anything new (as God requires a pedantic morality from creative discoverers and inventors), He does NOT impose any requirements onto the environment and upbringing of artists (as He does it with discoverers and inventors - see item #F3 on the web page named [wszewilki\\_uk.htm](#)), etc., etc. In reality, if the humanity never has e.g. Hemingway or Picasso, its fate still would remain as it is now. Whatever we have and accomplished as a civilisation and a country, we actually own this to our inventors. Also whatever we have in our homes and at work, that makes our lives comfortable, easy, and civilised, we also own this to them. Furthermore, there seems to be a unique **moral law** operating in the universe with the iron hand, which promotes inventions by rewarding countries which facilitate their technical development, and simultaneously punishing countries which oppress their inventors. This moral law causes, that **the fate of all citizens of a given nation always follows the way these citizens treat their inventors**. For this reason, each invention that is squashed or hold back, is actually disadvantaging every single one of us, as well as our children, grandchildren, etc.

Creative inventors can be compared to geese that lie golden eggs. The logic tells us, that if someone has a goose that lies golden eggs, such someone should nourish it, take a good care of it, encourage it to lie more eggs, and help it in the difficult burden of actual laying these eggs. However, the reality seems to be, that usually such someone chases this goose with a big stick. When, in spite of constantly being chased, the goose still manages to lie a golden egg, frequently it is being cooked in punishment for it.

## #H3. Present people are embarrassed by their ancestors whose immorality, prejudice and backwardness held back

## progress, but simultaneously the same people treat present inventors in the exact manner their ancestors did:

Personally I am fascinated by the manner on which present people try to compensate mistakes and behaviours of their ancestors who reinforced backwardness and ignorance through persecuting inventors that could bring progress. Simultaneously the same people repeat towards present inventors exactly the same mistakes which their ancestors did. An excellent symbol of just such mistakes is the monument erected for someone named **Richard Pearse** - described on the web page [mozajski\\_uk.htm](#) (i.e. the one who was NOT allowed by his countrymen to build an airplane). This is because countrymen of the people who build this monument now obstruct the implementation of e.g. the invention that is described on the web page [boiler.htm](#).

For this reason I have an appeal to the reader. Namely, in your own behaviour please do NOT repeat the stand towards new inventions which would be similar to the one displayed by such people. Rather already now accept and implement in practice the principle of totalizm which states that "**whatever can be conceived, it can also be achieved**" (we only need to find a way how to accomplish it). It is a proof of the complete lack of imagination to persecute someone only because he or she tries to complete something that extends beyond our knowledge and our capability to understand.

## #H4. Knowledge of the operation of the "curse of inventors" also has its advantages:

**Motto: "Everything that we know above the knowledge of other people gives to us the 'competitive advantage'."**

Many people do NOT wish to know about such "truths" as for example the action of the "curse of inventors" - described here, or the information that "bones of dinosaurs were intentionally 'fabricated' by **God** to make humans seek further knowledge" - described in item #C1 of the web page named [prawda\\_uk.htm](#). On the other hand, "every knowledge that one has above whatever other people typically know, is a source of the advantage over these other people" - and thus it can be turned into a source of someone's benefits. No wonder that in the English culture the meaningful question "what do you know that we do NOT know" is frequently asked in every situation when someone accomplished outcomes that surprise others. Therefore, also the knowledge about the existence and the action of the "curse of inventors" can be for us a source of various benefits.

An example of one amongst such benefits is the "disappearance of disappointment". For example, before I learned myself the fact that the "curse of inventors" is a kind of "punishment served by immoral nations and countries to themselves", I was very disappointed by both, my countrymen from Poland and by my hosts from New Zealand, that they stubbornly do NOT allow me to complete even a single amongst my numerous inventions. But now this disappointment ceased to exist. Now I know that in that way both these nations and countries are serving the "punishment" to themselves for their behaviours. Now I can only be sorry for them about consequences of the "inventive

impotency" that they bring at themselves with such their behaviours.

Another example of benefits that result from the knowledge of the "curse of inventors" is the outcome of "reversal" of the knowledge about the work and force of this curse. Namely, since "the 'curse of inventors' acts with the force that is proportional to the significance that a given invention is to have for the nation and for the country that is to implement this invention", this practically means that "inventions the implementation of which is blocked with the powerful action of the 'curse of inventors' are to turn out to be immensely vital for the progress of humanity". In turn this fact reveals to us which inventions are the most vital because on them concentrates the highest force of the action of the "curse of inventors". Therefore, this also reveals to me which inventions are worth promotion with the highest devotion. And so, due to this principle I already known that from my own inventions the most vital are to turn out in the future the [Oscillatory Chamber](#), [Magnocraft](#), [Time Vehicle](#), and [Telekinetic Cell](#). After all, these are my inventions on which concentrates the most destructive force of the "curse of inventors" to make me abandon their development and dissemination. This is why with such a devotion I am putting huge amount of my effort and labour into their promotion amongst other people. In turn out of "inventions" of other people the most vital are to turn out one day [Telepathic Pyramid](#), [Zhand Heng Seismograph](#), [Telekinetic Influenzmaschine](#), and [Davey's Sonic Boiler](#). Therefore, although with these "inventions" God blessed other people, still I myself consider to be my duty towards the humanity to put into their promotion as much of my own energy and labour as only it is possible in my circumstances. After all, I am aware that one day these inventions are to turn immensely vital for the advancement of entire human civilisation.

Notice, that because of the significance to our civilisation, the "curse of inventors" and also the so-called "**inventive impotency**" which stems from this curse, are described on a number of totaliztic web pages, for example in item #G1 from the web page named [eco cars.htm](#), in item #M3 from the web page named [fe cell.htm](#), in item #D1 from the web page named [boiler.htm](#), and in several further totaliztic publications.

---

**Part #I: The progress in generation of free energy requires the understanding of phenomena of telekinesis that are described by the "theory of everything" called the [Concept of Dipolar Gravity](#):**

**#I1. To understand free energy we need to learn about the phenomenon of telekinesis:**

In order to be successful in constructing free energy devices, we firstly need to learn how they work and what principles they involve. Because all free energy devices work on principles of telekinetic motion, thus in order for us to understand how these devices work,



we firstly need to learn more about telekinesis.

Principles of telekinetic motion are described comprehensively in chapter H from volume 4 of [monograph \[1/5\]](#). They are also summarised on several web pages, for example on [telekinesis.htm](#). But in case these resources are unavailable at this moment, I am going to repeat here the most vital details on the telekinetic motion.

## #12. How telekinesis works:

Imagine that you are able to move a reflection of any object in a mirror, without moving the mirror and without moving this object. Then, most probably, the motion of this reflection would cause that the original object would also be forced to move. Especially if light would behave like gravity forces. The new scientific theory called the **Concept of Dipolar Gravity** states, that our physical world is only the first of two parallel physical worlds that exist in our universe. This is because on the other end of gravity dipole, there is also another physical world called the **counter-world**. Both these worlds, means "our world" and the "counter-world", relate to each other just like objects and their mirror reflections. This also means that every known object exists in two physical copies, each one of which stays in a separate world. (Religions call these two copies with names "body" and "spirit" or "soul".) Both copies of the same object are tightly linked together with forces of gravity. Therefore, if one copy is moved, another copy must follow. If we are able to move the copy (spirit) which resides in this other world, then the motion of this copy is going to force the physical object to also move. Such motion that is initiated in this other world is called "telekinesis".

There is a wealth of empirical evidence which confirms that the counter-world definitely exists. For example, the existence of it can easily be proven through the behaviour of gravity force lines. Namely, the gravity field displays a dynamic dipolar character, similar to that of magnetic field, i.e. it has two poles (inlet "I" and outlet "O"). But in spite of this dipolar character, we see in our world only the first (inlet "I") pole of gravity field. This practically means, that the second pole of the dynamic dipolar gravity field must disappear from our world and emerge in this another, parallel world. Unfortunately, because in normal state all our senses remain in the physical world, we do not see what happens in this other parallel counter-world. (Our senses visit the counter-world only during hypnosis and during dream.) It is a bit like with people swimming in a sea - because their eyes remain above the water level, they do not see that below the surface there is an entire underworld. But the counter-world is described by almost all religions - it is that one in which our spirit and soul resides. Furthermore, the so-called **Kirlian photography** allows to see objects that exist in the counter-world, but do not exist in our world. Most clear images provided by this counter-world are revealed during the so-called "ghost-leaf experiment" with a Kirlian camera. In this experiment a part of the leaf is removed, while the incomplete leaf is placed on the camera. But the camera shows a complete leaf. In a similar way a Kirlian camera shows images of amputated fingers - copies of which are still present in the counter-world. (More on the "ghost-leaf effect" is explained in [treatise \[7/2\]](#).)

**The existence of the counter-world was also proven formally** by the **Concept of Dipolar Gravity** through the investigation of behaviours of gravity field - for wording of this formal scientific proof for the existence of counter-world see item #D3 from the web pager named [dipolar gravity.htm](#). (The relatively new scientific theory called the **Concept of Dipolar Gravity**, has determined, that gravity is a dipolar field, similar to magnetic fields. Thus, the second pole of the gravity field must go somewhere, since it does not appear in our world - means that it goes into this other world.) For more details on this formal proof see in subsection H1.1.4 from volume 4 of my newest [monograph \[1/5\]](#) entitled "**Advanced Magnetic Devices**", or subsection H1.1.4 from volume 4 of my older [monograph \[8/2\]](#) entitled **Totalizm** - both downloadable for free via this web site. Also

there is a wealth of empirical evidence available to interested researchers, like the "extraction glow" shown in "Fig. I1" from this web page (or H1 from [1/5]), which proves the existence of the counter world and also proves the real character of all phenomena which are triggered by this counter-world (like the phenomenon of "telekinetic motion").

An extremely interesting fact that this new "Concept of Dipolar Gravity" established about the counter-world, is that practically every material object which exists in our world, have a duplicate in it (religions call this duplicate a "spirit" or a "soul", although they get lost in explaining what is the difference between these two). To be more interesting, this duplicate can be moved with the use of capabilities of the counter-world. But when this duplicate is moved, the physical object must follow it (means when we move a "spirit" or a "soul", a "body" must follow it). This extraordinary type of motion, which is accomplished through moving firstly "spirits" of physical objects, is called a "telekinetic motion". It is possible to build technical devices which are to produce such a motion. Several such devices are described in volumes 9 to 15 of my newest [monograph \[1/5\]](#), and also here on this web page. The most interesting one amongst these devices is a space vehicle called [magnocraft](#), which utilises "telekinetic motion" for instant flights to distant star systems. There is a separate web site about this space vehicle. This site is named [propulsion.htm - about advanced magnetic propulsion systems](#). Please have a look at it.

## #13. Mechanism of Telekinesis:

In subsection H6.1 of [monograph \[1/5\]](#) there is a description of telekinetic motion, which illustratively explains how to understand this phenomenon in the light of the "Concept of Dipolar Gravity". I am quoting below this description because it quite well illustrates the mechanism that telekinetic motion implements. Here is this quotation:

*The Concept of Dipolar Gravity postulates, that the universe must be composed of two parallel physical worlds (i.e. our world, and the counter-world), the attributes of which are to each other as attributes of spaces that prevail at opposite poles of magnetic dipoles. These two worlds are separated from each other by impenetrable barrier, while to each one of them an opposite pole of gravity extends. Because of the nature of gravity, which requires that this field must always link some clusters of substances, all gravity dipoles are behaving as kinds of "marriage bounds", which link with each other into symmetrical pairs, all similar particles of substances that prevail on both ends of a given gravity dipole (i.e. in both worlds). In the result, for every object that exist in one of these two worlds, the gravity field forms an identical duplicate that appears in the second of these two worlds. Thus one of the major discoveries of the Concept of Dipolar Gravity, is the postulate, that all material objects that exist in our set of dimensions (i.e. in our world) must have their counter-material duplicates that exist in the parallel set of dimensions (i.e. in the counter-world). Actually the existence of these counter-material duplicates can already be conclusively proven with our present technology by showing it with the use of Kirlian cameras. The best experiment which proves the existence of counter-material duplicates is the "leaf ghost effect" described by Daniela Giordano in subsection C9 of treatise [7/2]. (In this effect the Kirlian camera shows the shape of a counter-material duplicate of a whole leaf, even if someone cuts this leaf in half and puts on the camera only a half of it.) The mutual relationship between each material object and its counter-material duplicate is an analogy to an image and its mirror reflection, or to computer hardware and software, or to the idea of 'body' and 'spirit' postulated by various religions. Similarly like an image and its mirror reflection, both parts of an object are exact copies of their opposite duplicate, and also exactly imitate each other's movements. Moreover, both - the material object and its counter-material duplicate - can also be independently taken hold of and dislocated in space. But because of the gravitational links between them, independently of which part is grabbed and dislocated*

*first, the other part must imitate exactly its motion. For this reason, depending on which part of an object is grabbed first and thus first dislocated in space, the new Concept of Dipolar Gravity distinguishes between two different types of motion, i.e. the "physical motion" and the "telekinetic motion". **Physical motion** occurs when the material part of an object is moved first, whereas the counter-material duplicate is pulled behind it by forces of the gravitational links. In turn **telekinetic motion** occurs when the counter-material duplicate is moved first, whereas the material part of this object is pulled behind the counter-material duplicate by forces of their mutual gravitational links. To illustrate this with an example, the Concept of Dipolar Gravity shows that the telekinetic motion is like forcing an object to move by shifting its reflection in a mirror, so that this re-located reflection causes the object to move also. Of course in order for this example to work in reality, light would need to behave like gravity forces. The other, even more illustrative explanation for the telekinetic motion would be to liken it to "shifting material objects by dislocating their counter-material 'spirits'".*

This is the end of quotation from chapter H of monograph [monograph \[1/5\]](#) (and also from chapter L of monograph [8]). Although this quotation explains the essence of telekinetic motion, there is still a lot to this phenomenon, which because of the sparse volume of this web page, I am not even attempting to explain here. Therefore I recommend to download to your computer copies of volumes 4 and 5 from the English version of [monograph \[1/5\]](#) (after all, this monograph is available here for free), and then read at your leisure chapters H and I of that [monograph \[1/5\]](#). You should be able to find in these two chapters (H and I) explanations for all phenomena that ever puzzled you.



**Fig. #I1:**The above photograph captured an unique ghostly white glow called the "extraction glow". In past just such a glow was considered to be "supernatural". On this photograph it is emitted from the space that surrounds a divining rod moved on principles of telekinesis. It is from this space that the Telekinetic Effect absorbed rapidly all heat, thus forcing atoms of the air to emit a white glow. Such a ghostly white extraction glow, together with a drop in the environmental temperature, are two most important indicators of telekinetic motion. They allow to distinguish between a telekinetic motion and a physical motion. (The above photograph originally is presented in monograph [monograph \[1/5\]](#), where appears as Figure H1. Also Figure L1 from [monograph \[8\]](#), Figure D5 from [monograph \[1e\]](#), and Figure C1 from [monograph \[2e\]](#). All these monographs are downloadable free of charge via this web site.)

In old days such a ghostly white glow was considered to be "supernatural" because it was formed by strange devices and strange creatures that people in old days considered to belong to the realm of "devils", "angels", or "gods". Presently we know that this type of white, ghostly light is produced by extraterrestrial vehicles popularly known as UFOs, that are propelled on principles of telekinetic motion. Descriptions and technical details of UFOs you can find in chapters P to U of [monograph \[1/5\]](#) and also on the web site [ufo.htm - about UFOonauts](#).

---

## **Part #J: Summary, and the final information of this web page:**

### **#J1. Summary of this web page:**

This web page reveals, that in spite of obstacles and persecutions such as the **curse of inventors** described above in item #H1 (as well as e.g. in item #G1 of the web page named [eco cars.htm](#) and on several other web pages indicated above) - which curse tries to suppress the completion of "generators of free energy" described here, such generators still slowly eventuate to become a reality. Already numerous working prototypes of these devices do exist. Furthermore, new ideas and better principles of free energy are gradually developed by devoted hobbyists-inventors. Thus, as this is clearly visible, evil powers are unable to block completely the progress of this new technology on the Earth, although have noticeable successes in holding back this technology. So there is still a hope for a better future for the human race.

### **#J2. The author of this web page - Dr Jan Pajak:**



**Fig. #J1: Dr Jan Pajak** , means myself, shown on the background of pristine New Zealand landscape. Until the most recent redundancy from the job, I lectured computer science in a New Zealand polytechnic. I specialised in Web Technologies and in Information Processing using Web Technologies. Before that I worked at two universities as Associate Professor of Mechanical Engineering. From old times I have also quite a good knowledge of engineering, sciences, and mathematics, towards which my education and a significant proportion of professional experience was oriented. However, my so-called "hobby" research, carried out continually since 1972, amongst others, is aimed at the development of new ideas and new directions for technologies and human outlooks of the future, including new futuristic propulsion systems, new energy generation and storing devices, new communication devices, new systems for remote detection of impending earthquakes, new advanced earthquake warning systems, and many more. Unfortunately, this research is my "hobby" not by the own choice, but by necessity, or by "must". This is because my over 30 years long searches for a research institution which would accept my continually open offer of official researching these topics, so-far are unsuccessful (i.e. it well may be that at the moment there is no such institution on our planet - if by any chance you accidentally find or create one, please make sure to let me know). Also the name "hobby" completely does not fit to the subject area of this research. After all, it implies the orientation mainly towards gaining various personal benefits. However, what kind of personal benefits one may accomplish through building a starship, an accumulator of energy of a huge capacitance, or an alarming device that warns of an impending earthquake. Because, as so-far, an institution on Earth does not exist that would be interested in sponsoring this research, to earn somehow for the financing of this research (and also for my own living), until the time when I lost my most recent job on 23 September 2005, I used to do a basic lecturing and research in any area for which I was hired to work. In turn funds that I managed to earn, and almost the entire spare time I have in my disposal, I devoted to this "hobby" research on technologies and philosophies of the future. (Since the time I become unemployed, I have even more of free time which I can designate for this "hobby" research. Unfortunately, now the financing begins to be a serious problem. This is because according to the New Zealand law I am not eligible for any unemployment benefit.) For more details

about the course of my life and fate, see the web page [about me](#) listed in the "[Menu 4](#)".

## #J3. Emails to the [author](#) of this web page:

Current email addresses to the author of this web page, i.e. officially to [Dr Eng. Jan Pajak](#) while courteously to **Prof. Dr Eng. Jan Pajak**, at which readers can post possible comments, opinions, descriptions, or information which in their opinion I should learn, are provided on the web page named [pajak\\_jan\\_uk.htm](#) (for its version in the HTML language), or the web page named [pajak\\_jan\\_uk.pdf](#) (for the version of the web page "pajak\_jan\_uk.pdf" in safe PDF format - which safe PDF versions of further web pages by the author can also be downloaded via links from item #B1 of the web page named [text 11.htm](#)).

The author's right for the use of **courteous** title of "Professor" stems from the custom that "with professors is like with generals", namely **when someone is once a professor, than he or she courteously remains a professor forever**. In turn the author of this web page was a professor at 4 different universities, i.e. at 3 of them, from 1 September 1992 untill 31 October 1998, as an "Associate Professor" from English-based educational system, while on one university as a (Full) "Professor" (since 1 March 2007 till 31 December 2007 - means at the last place of employment in his professional life).

However, please notice that because of my rather chronic lack of time, **I reluctantly reply to emails which contain JUST time consuming requests**, while simultaneously they document a complete ignorance of their author in the topic area which I am researching. Therefore, if the reader sends a request to me, I suggest to let me know somehow that he or she actually went through the trouble of reading my web pages and learning what these pages try to say.

## #J4. How with the web page named "[skorowidz links.htm](#)" one can find totaliztic descriptions of topics in which he is interested:

A whole array of topics equally interesting as these from the above web page, is also discussed from the angle that is unique to the philosophy of totalizm. All these related topics can be found and identified with the use of [content index](#) prepared especially to make easier finding these web pages and topics. The name "index" means a list of "key words" usually provided at the end of textbooks, which allows to find fast the description or the topic in which we are interested. My web pages also has such a content "index" - only that it is additionally supplied in green [links](#) which after "clicking" at them with a mouse immediately open the web page with the topic that interest the reader. This content "index" is provided on the web page named [skorowidz links.htm](#). It can be called from the "organising" part of "Menu 1" of every totaliztic web page. I would recommend to look at it and to begin using it systematically - after all it brings closer hundreds of totaliztic topics which can be of interest to everyone.

## #J5. A copy of this web page is also disseminated as a brochure from series [11] in the safe format "PDF":

This web page is also available in the form of a brochure marked [11], which is prepared in "PDF" ("Portable Document Format") - currently considered to be the most safe amongst all internet formats, as normally viruses cannot cling to PDF. This clear brochure is ready both, for printing, as well as for reading from a computer screen. It also has all its green links still active. Thus, if it is read from the computer screen connected to internet, then after clicking onto these green links, the linked web pages and illustrations will open. Unfortunately, because the volume of it is around a double of the volume of web page which this brochure publishes, the memory limitations on a significant number of free servers which I use, do NOT allow to offer it from them (so if it does NOT download from this address, because it is NOT available on this server, then you should click onto any other address from Menu 3, and then check whether in there it is available). In order to open this brochure (and/or download it to own computer), it suffices to either click on the following green link

[free energy.pdf](#)

or to open from any totaliztic web site the PDF file named as in the above green link.

If the reader wishes to check, whether some other totaliztic web page which he or she just is studying, is also available in the form of such PDF brochure, then should check whether it is listed amongst links from "part #B" of the web page named text 11.htm. This is because links from there indicate all totaliztic web pages, which are already published as such brochures from series [11] in PDF format. I wish you a fruitful reading!

## #J6. Copyrights © 2013 by Dr Jan Pajak:

Copyrights © 2013 by Dr Jan Pajak. All rights reserved. This web page is a report from outcomes of research of the author - only that is written in a popular language (so that it can be understood by readers with non-scientific orientation). Ideas presented on this web page (and also in other publications by the author) are unique for the author's research, and thus from the same angle these ideas were NOT presented by any other researcher. As such, this web page presents ideas which are the intellectual property of the author. Therefore, the content of this web page is the subject to the same laws of intellectual ownership as every other scientific publication. Especially the author reserves for himself the credit-rights for the scientific discoveries and inventions described on this web page. Therefore, the author reserves that during repeating any idea presented on this web page (i.e. any theory, principle, deduction, interpretation, device, evidence, proof, etc.), the repeating person gives a full credit to the author of this web page, through clearly explaining that the author of a given idea and/or research is Dr Jan Pajak, through indicating the internet address of this web page under which this idea was published, and through mentioning the date of most recent update of this web page (i.e. the date indicated below).

\* \* \*

**Jeśli wolisz czytać po polsku,  
kliknij na polską flagę**

(if you prefer to read in Polish  
click on the Polish flag)



Date of starting this web page: 25 May 2003  
Date of the most recent update of this page: 7 July 2013  
(Check in "Menu 3" whether there is even a more recent update!)  
[click on this counter of visits](#)