

ONKYO®

AV Receiver

TX-SR701/701E *TX-SR601/601E*

Instruction Manual

Thank you for purchasing the Onkyo AV Receiver. Please read this manual thoroughly before making connections and plugging in the unit. Following the instructions in this manual will enable you to obtain optimum performance and listening enjoyment from your new AV Receiver. Please retain this manual for future reference.

Contents

Before using	2
---------------------	----------

Facilities and connections	8
-----------------------------------	----------

Setup and operation	31
----------------------------	-----------

Remote controller	63
--------------------------	-----------

Appendix	75
-----------------	-----------

WARNING:

TO REDUCE THE RISK OF FIRE OR ELECTRIC SHOCK, DO NOT EXPOSE THIS APPLIANCE TO RAIN OR MOISTURE.

CAUTION:

TO REDUCE THE RISK OF ELECTRIC SHOCK, DO NOT REMOVE COVER (OR BACK). NO USER-SERVICEABLE PARTS INSIDE. REFER SERVICING TO QUALIFIED SERVICE PERSONNEL.



WARNING
RISK OF ELECTRIC SHOCK
DO NOT OPEN

AVIS
RISQUE DE CHOC ELECTRIQUE
NE PAS OUVRIR



The lightning flash with arrowhead symbol, within an equilateral triangle, is intended to alert the user to the presence of uninsulated "dangerous voltage" within the product's enclosure that may be of sufficient magnitude to constitute a risk of electric shock to persons.



The exclamation point within an equilateral triangle is intended to alert the user to the presence of important operating and maintenance (servicing) instructions in the literature accompanying the appliance.

Important Safety Instructions

- 1. Read Instructions** – All the safety and operating instructions should be read before the appliance is operated.
- 2. Retain Instructions** – The safety and operating instructions should be retained for future reference.
- 3. Heed Warnings** – All warnings on the appliance and in the operating instructions should be adhered to.
- 4. Follow Instructions** – All operating and use instructions should be followed.
- 5. Water and Moisture** – Do not use the appliance near water – for example, near a bath tub, wash bowl, kitchen sink, or laundry tub; in a wet basement; or near a swimming pool; and the like.
- 6. Cleaning** – Unplug the appliance from the wall outlet before cleaning. The appliance should be cleaned with a dry cloth or only as recommended by the manufacturer.
- 7. Ventilation** – Slots and openings in the cabinet are provided for ventilation and to ensure reliable operation of the appliance and to protect it from overheating, and these openings must not be blocked or covered. Do not use the appliance on a bed, sofa, rug, or other such surface. Newspapers, table clothes, curtains, and other items can inadvertently block ventilation slots. Do not place the unit near curtains that could obstruct the ventilation. If you install the appliance in a built-in installation, such as a bookcase or rack, ensure that there is adequate ventilation. Leave 20 cm (8") of free space at the top and sides and 10 cm (4") at the rear. The rear edge of the shelf or board above the appliance should be set 10 cm (4") away from the rear panel or wall, creating a flue-like gap for warm air to escape.
- 8. Heat** – The appliance should be situated away from heat sources such as radiators, heat registers, stoves, or other appliances (including amplifier) that produce heat.
- 9. Grounding or Polarization** – The appliance may be equipped with a polarized alternating current line plug (a plug having one blade wider than the other). This plug will fit into the power outlet only one way. This is a safety feature. If you are unable to insert the plug fully into the outlet, try reversing the plug. If the plug should still fail to fit, contact your electrician to replace your obsolete outlet. Do not defeat the safety purpose of the polarized or grounding-type plug.
A grounding type plug has two blades and a third grounding prong. The wide blade or the third prong are provided for your safety. If the provided plug does not fit into your outlet, consult an electrician for replacement of the obsolete outlet.
- 10. Power-Cord Protection** – Power-supply cords should be routed so that they are not likely to be walked on or pinched by items placed upon or against them, paying particular attention to cords at plugs, convenience receptacles, and the point where they exit from the appliance.
- 11. Attachments** – Do not use attachments not recommended by the appliance manufacturer as they may cause hazards.
Accessories – Do not place the appliance on an unstable cart, stand, tripod, bracket, or table. The appliance may fall, causing serious injury to a child or adult, and serious damage to the appliance. Use only with a cart, stand, tripod, bracket, or table recommended by the manufacturer, or sold with the appliance. Any mounting of the appliance should follow the manufacturer's instructions, and should use a mounting accessory recommended by the manufacturer.
- 12. An appliance and cart combination should be moved with care to avoid injury from tip-over.**
Quick stops, excessive force, and uneven surfaces may cause the appliance and cart combination to overturn.
- 13. Lightning** – For added protection for the appliance during a lightning storm, or when it is left unattended and unused for long periods of time, unplug it from the wall outlet and disconnect the antenna or cable system. This will prevent damage to the appliance due to lightning and power-line surges.
- 14. Servicing** – Do not attempt to service the appliance yourself as opening or removing covers may expose you to dangerous voltage or other hazards. Refer all servicing to qualified service personnel.
Damage Requiring Service – Unplug the appliance from the wall outlet and refer servicing to qualified service personnel under the following conditions:
 - When the power-supply cord or plug is damaged,
 - If liquid has been spilled, or objects have fallen into the appliance,
 - If the appliance has been exposed to rain or water,
 - If the appliance does not operate normally by following the operating instructions. Adjust only those controls that are covered by the operating instructions as an improper adjustment of other controls may result in damage and will often require extensive work by a qualified technician to restore the appliance to its normal operation,
 - If the appliance has been dropped or damaged in any way, and
 - When the appliance exhibits a distinct change in performance – this indicates a need for service.
- 15. Object and Liquid Entry** – Never push objects of any kind into the appliance through openings as they may touch dangerous voltage points or short-out parts that could result in a fire or electric shock.
The appliance should not be exposed to dripping or splashing and no objects filled with liquids, such as vases should be placed on the appliance.
Don't put candles or other burning objects on top of this unit.
- 16. Batteries** – Always consider the environmental issues and follow local regulations when disposing of batteries.

PORTABLE CART WARNING



S3125A

Precautions

1. Recording Copyright

Recording of copyrighted material for other than personal use is illegal without permission of the copyright holder.

2. AC Fuse

The fuse is located inside the chassis and is not user-serviceable. If power does not come on, contact your Onkyo authorized service station.

3. Care

From time to time you should wipe the front and rear panels and the cabinet with a soft cloth. For heavier dirt, dampen a soft cloth in a weak solution of mild detergent and water, wring it out dry, and wipe off the dirt. Following this, dry immediately with a clean cloth. Do not use rough material, thinners, alcohol or other chemical solvents or cloths since these could damage the finish or remove the panel lettering.

4. Power

WARNING

BEFORE PLUGGING IN THE UNIT FOR THE FIRST TIME, READ THE FOLLOWING SECTION CAREFULLY.

The voltage of the available power supply differs according to country or region. Be sure that the power supply voltage of the area where this unit will be used meets the required voltage (e.g., AC 230 V, 50 Hz or AC 120 V, 60 Hz) written on the rear panel.

Worldwide models are equipped with a voltage selector to conform to local power supplies. Be sure to set this switch to match the voltage of the power supply in your area before plugging in the unit.

For British models

Replacement and mounting of an AC plug on the power supply cord of this unit should be performed only by qualified service personnel.

IMPORTANT

The wires in the mains lead are colored in accordance with the following code:

- Blue : Neutral
- Brown : Live

As the colors of the wires in the mains lead of this apparatus may not correspond with the colored markings identifying the terminals in your plug, proceed as follows:

The wire which is colored blue must be connected to the terminal which is marked with the letter N or colored black.

The wire which is colored brown must be connected to the terminal which is marked with the letter L or colored red.

IMPORTANT

A 5 ampere fuse is fitted in this plug. Should the fuse need to be replaced, please ensure that the replacement fuse has a rating of 5 amperes and that it is approved by ASTA or BSI to BS1362. Check for the ASTA mark or the BSI mark on the body of the fuse.

IF THE FITTED MOULDED PLUG IS UNSUITABLE FOR THE SOCKET OUTLET IN YOUR HOME THEN THE FUSE SHOULD BE REMOVED AND THE PLUG CUT OFF AND DISPOSED OF SAFELY. THERE IS A DANGER OF SEVERE ELECTRICAL SHOCK IF THE CUT OFF PLUG IS INSERTED INTO ANY 13 AMPERE SOCKET.

If in any doubt, consult a qualified electrician.

For U.S. models

Note to CATV system installer:

This reminder is provided to call the CATV system installer's attention to Section 820-40 of the NEC which provides guidelines for proper grounding and, in particular, specifies that the cable ground shall be connected to the grounding system of the building, as close to the point of cable entry as practical.

FCC INFORMATION FOR USER

CAUTION:

The user changes or modifications not expressly approved by the party responsible for compliance could void the user's authority to operate the equipment.

NOTE:

This equipment has been tested and found to comply with the limits for a Class B digital device, pursuant to Part 15 of the FCC Rules. These limits are designed to provide reasonable protection against harmful interference in a residential installation. This equipment generates, uses and can radiate radio frequency energy and, if not installed and used in accordance with the instructions, may cause harmful interference to radio communications. However, there is no guarantee that interference will not occur in a particular installation. If this equipment does cause harmful interference to radio or television reception, which can be determined by turning the equipment off and on, the user is encouraged to try to correct the interference by one or more of the following measures:

- Reorient or relocate the receiving antenna.
- Increase the separation between the equipment and receiver.
- Connect the equipment into an outlet on a circuit different from that to which the receiver is connected.
- Consult the dealer or an experienced radio/TV technician for help.

For Canadian models

NOTE: THIS CLASS B DIGITAL APPARATUS COMPLIES WITH CANADIAN ICES-003.

For models having a power cord with a polarized plug:

CAUTION: TO PREVENT ELECTRIC SHOCK, MATCH WIDE BLADE OF PLUG TO WIDE SLOT, FULLY INSERT.

Modèle pour les Canadien

REMARQUE: CET APPAREIL NUMÉRIQUE DE LA CLASSE B EST CON-FORME À LA NORME NMB-003 DU CANADA.

Sur les modèles dont la fiche est polarisée:

ATTENTION: POUR ÉVITER LES CHOCS ÉLECTRIQUES, INTRODUIRE LA LAME LA PLUS LARGE DE LA FICHE DANS LA BORNE CORRESPONDANTE DE LA PRISE ET POUSSER JUSQU'AU FOND.

Contents

Before using

Important Safety Instructions	2
Precautions	3
Contents	4
Features	6
Supplied accessories	7
Before using this unit	7
Setting the voltage selector (Worldwide models only)	7
Installing the remote controller batteries	7
Using the remote controller	7

Facilities and connections

Front panel facilities	8
Front panel	8
Front panel display	11
Remote controller	12
Connections	14
TX-SR701/701E	15
TX-SR601/601E	15
Connecting your audio components	16
Connecting your video components	17
12V TRIGGER ZONE 2 terminal	21
PRE OUT (TX-SR701/701E only)	21
Operating components not reached by the remote controller signals (IR IN)	22
If the remote controller signal does not reach the TX-SR701/701E/601/601E remote sensor	22
Connecting the remote zone (Zone 2) speakers ...	23
When using the ZONE 2 SPEAKERS terminals	23
When using the ZONE 2 LINE OUT terminals	23
When using the ZONE 2 PRE OUT terminals (TX-SR701/701E only)	23
Connections	24
AC OUTLETS	24
RI REMOTE CONTROL	24
Connecting speakers	25
Standard speaker setup for surround sound	25
Minimum speaker configuration for surround sound playback	25
Speaker placement	25
Using the speaker cable labels	26
Connecting a subwoofer	26
Connecting the surround back speakers (TX-SR701/701E only)	26
Connecting speakers	27
Connecting the speaker cable	27
Connecting the power	28
Connecting a subwoofer	28
Turning on the power	28
Turning on the power from the remote controller	28

Connecting antennas 29

Assembling the AM loop antenna	29
Connecting the AM antenna cable	29
Connecting the included antennas	29
Connecting an FM outdoor antenna	30
Connecting an AM outdoor antenna	30
Directional linkage	30
Connecting the antenna cable to the 75/300 Ω antenna adapter (For all models other than USA & Canadian models and European models)	30

Setup and operation

Configuring the speakers 31

Displaying the Main Menu	31
Speaker Configuration	31
Setting the speaker distance from your normal listening position	33
Calibrating the speaker levels	34
Buttons used for navigating through the menus	36

Listening to Radio Broadcasts 37

Tuning into a radio station	37
Listening to a stereo radio station (FM mode)	37
Presetting a radio station	38
Selecting a preset radio station	38
Erasing a preset radio station	38

Listening to RDS broadcasts (European models only) 39

Listening to RDS broadcasts	39
PTY program types in Europe	39
Displaying Radio Text (RT)	40
Performing a PTY scan	40
Performing a TP scan	40

Selecting an Audio Component 41

Basic operation	41
Selecting the type of audio input signal	42
Temporarily changing the speaker output levels	43
To change the display of the input source from TAPE to MD	43
Using the sleep time (remote controller only)	44
Listening with headphones	44
Enjoying DVD multichannel audio playback	44
Switching the display	45
Temporarily turning off the sound	45

Listening Modes 46

Selecting a listening mode (TX-SR701/701E)	48
Re-EQ function for movies (TX-SR701/701E only)	49
Selecting a listening mode (TX-SR601/601E)	50
Original filter (CinemaFILTER) loading for movies (TX-SR601/601E only)	51

Input Setup 52

Hardware Setup 55

Hardware Config	55
-----------------------	----

Contents

Preference	56
Preference	56
Audio Adjust	57
Enjoying music in the remote zone	60
Using the buttons	60
Using the remote controller	60
Adjusting the volume for the remote zone	60
Recording	61
Recording the input source (REC OUT selector)	61
Recording both the audio and video	62

Remote controller

Using remote controller	63
Overview	63
Calling up a preset radio station	63
Controlling an Onkyo cassette tape deck	63
Controlling an Onkyo DVD player	64
Controlling an Onkyo CD player	65
Controlling an Onkyo MD recorder	66
Entering a pre-programming code	67
Learning a pre-programming code	67
Pre-programming codes	68
Operating your programmed remote controller	69
DVD MODE (DVD Player Mode)	69
SAT MODE (Satellite Tuner Mode)	69
CABLE MODE (Cable Mode)	69
VCR MODE (VCR Mode)	70
TV MODE (TV Mode)	70
Programming the commands of remote controllers for other devices into the remote controller	71
Programming procedure	71
Erasing the programmed command from one button	72
Erasing all the commands programmed under a MODE button	72
Using the macro function	73
What is the macro function?	73
Programming the macro	73
Executing the macro	73
Erasing a macro from the MACRO 1 (or 2) button	74
Erasing all commands and macros that have been programmed	74

Appendix

Troubleshooting guide	75
POWER	75
SPEAKERS	75
FM/AM TUNER	75
VIDEO and AUDIO	76
REMOTE CONTROLLER	76
OTHER	76
If one of the messages shown below appears	77
Specifications (TX-SR701/701E)	78
Specifications (TX-SR601/601E)	79

Declaration of Conformity

We, ONKYO EUROPE
ELECTRONICS GmbH
INDUSTRIESTRASSE 20
82110 GERMERING,
GERMANY



declare in own responsibility, that the ONKYO product described in this instruction manual is in compliance with the corresponding technical standards such as EN60065, EN55013, EN55020 and EN61000-3-2, -3-3.

GERMERING, GERMANY

I. MORI

ONKYO EUROPE ELECTRONICS GmbH

Features

TX-SR701/701E

Amplifier Features

- 100 W × 2 (Front)/ 100 W (Center)/ 100 W × 2 (Surround)/ 100 W (Surround Back) at 8 ohms, 20 Hz - 20 kHz, 0.08 % THD (FTC rated)
- 130 W × 2 (Front)/ 130 W (Center)/ 130 W × 2 (Surround)/ 130 W (Surround Back) at 6 ohms, 1 kHz (DIN)
- 160 W × 2 (Front)/ 160 W (Center)/ 160 W × 2 (Surround)/ 160 W (Surround Back) at 6 ohms, 1 kHz (JEITA)
- Wide Range Amplifier Technology (WRAT)
- Powered Zone 2 Capability
- State-of-the-art linear PCM 192 kHz/24-bit DACs for All channels
- Optimum gain volume circuitry
- VLSC (Vector Linear Shaping Circuitry) for L/C/R Channels

Audio/Video Features

- THX[®] Select certified
- THX surround EX[®]
- Dolby[®]* Digital, Dolby Digital EX, Dolby Pro Logic II
- DTS, DTS 96/24, DTS-ES Extended Surround, DTS Neo:6
- Non-Scaling Configuration
- Re-EQ
- Pure Audio Mode
- Crossover Adjustment (40/60/80/100/120/150 Hz)
- Onscreen graphical displays
- Digital Outputs (1 coaxial, 1 optical)
- 2 component video inputs and 1 output
- 3 Assignable digital inputs (1 coaxial, 2 optical)
- 5 S-Video inputs and 3 outputs
- Front panel A/V, S-Video, Optical inputs
- Multi channel input for DVD-Audio and Super Audio CD
- Rec out selector and Zone 2 selector
- Pre-out terminals for Front L/R, Center, Surround L/R, Surround Back L/R, Subwoofer and Zone 2 L/R
- Color-coded speaker terminals

FM/AM Tuner Features

- 40 FM/AM random presets
- FM auto tuning
- RDS (European models) with PS/RT/PTY/TP

Other Performance Features

- IntelliVolume
- Powerful backlit/preprogrammed learning remote with macro and mode-key LEDs
- 12V Trigger output for Zone 2
- IR input terminal
- Zone 2 Lineout

TX-SR601/601E

Amplifier Features

- 85 W × 2 (Front)/ 85 W (Center)/ 85 W × 2 (Surround)/ 85 W (Surround Back) at 8 ohms, 20 Hz - 20 kHz, 0.08 % THD (FTC rated)
- 120 W × 2 (Front)/ 120 W (Center)/ 120 W × 2 (Surround)/ 120 W (Surround Back) at 6 ohms, 1 kHz (DIN)
- 150 W × 2 (Front)/ 150 W (Center)/ 150 W × 2 (Surround)/ 150 W (Surround Back) at 6 ohms, 1 kHz (JEITA)
- Wide Range Amplifier Technology (WRAT)
- Powered Zone 2 Capability
- State-of-the-art linear PCM 192 kHz/24-bit DACs for All channels
- Optimum gain volume circuitry
- VLSC (Vector Linear Shaping Circuitry) (except for USA & Canadian models, Australian models)

Audio/Video Features

- Dolby Digital, Dolby Digital EX, Dolby Pro Logic II
- DTS, DTS 96/24, DTS-ES Extended Surround, DTS Neo:6
- Non-Scaling Configuration
- CinemaFILTER
- Crossover Adjustment (60/80/100/120/150 Hz)
- Onscreen graphical displays
- Optical Digital Output
- 2 component video inputs and 1 output
- 3 Assignable digital inputs (1 coaxial, 2 optical)
- 5 S-Video inputs and 3 outputs
- Front panel A/V, S-Video, Optical inputs
- Multi channel input for DVD-Audio and Super Audio CD
- Rec out selector and Zone 2 selector
- Pre-out terminal for Subwoofer
- Color-coded speaker terminals

FM/AM Tuner Features

- 40 FM/AM random presets
- FM auto tuning
- RDS (European models) with PS/RT/PTY/TP

Other Performance Features

- IntelliVolume
- Preprogrammed learning remote with macro and mode-key LEDs
- Zone 2 Lineout
- 12V Trigger output for Zone 2
- IR input terminal

- *Manufactured under license from Dolby Laboratories. "Dolby," "Pro Logic," "Surround EX" and the double-D symbol are trademarks of Dolby Laboratories.
- "Theater-Dimensional" is a trademark of Onkyo Corporation.
- Lucasfilm THX and THX are trademarks or registered trademarks of THX Ltd. All rights reserved. Used under authorization.
- "DTS," "DTS-ES Extended Surround," and "Neo:6" are trademarks of Digital Theater Systems, Inc.
- Xantech is a registered trademark of Xantech Corporation.
- Niles is a registered trademark of Niles Audio Corporation.
- Re-Equalization and the "Re-EQ" logo are trademarks of THX Ltd. Manufactured under license of THX Ltd.

The alphabet displayed at the end of the product name found in catalogs and on the packages represents the color of this receiver. Though the color varies, the specifications and operations are the same.

Supplied accessories

Check that the following accessories are supplied with the TX-SR701/701E/601/601E.

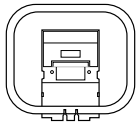

AM loop antenna × 1

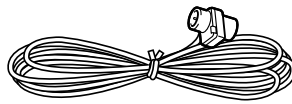

FM indoor antenna × 1

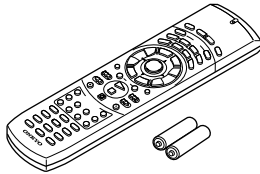

Remote controller × 1
TX-SR701/701E: RC-533M
TX-SR601/601E: RC-515M
Batteries (AA, R6) × 2

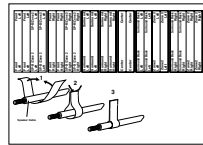

Speaker cable label × 1

The following accessories may be available depending on the area which it was purchased.

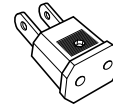

Conversion plug × 1

(Use this plug if the power cord plug of the TX-SR701/701E/601/601E does not fit your AC outlet. Shape may vary depending on the area which it was purchased.)

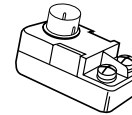

75/300 Ω antenna adapter × 1

Before using this unit

Setting the voltage selector (Worldwide models only)

Worldwide models are equipped with a voltage selector so that you can set your TX-SR701/701E/601/601E to conform with local power supplies. Be sure to set this switch to match the voltage of the power supply in your area before plugging in the unit. Determine the proper voltage for your area: 220-230 V or 120 V. If the preset voltage is not correct for your area, insert a screwdriver into the groove in the switch and slide the switch all the way to the top (120 V) or bottom (220-230 V), whichever is appropriate.

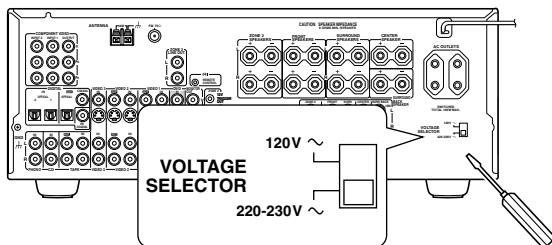

Installing the remote controller batteries

1. Remove the battery compartment cover by pressing it and sliding it in the direction shown by the arrow below.
2. Insert two AA (R6) batteries into the battery compartment. Carefully follow the polarity diagram (positive (+) and negative (-) symbols) inside the battery compartment.
3. After the batteries are installed and seated correctly, replace the compartment cover.

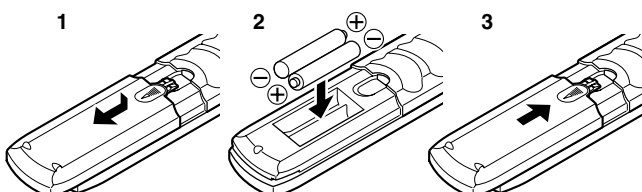

Notes:

- Do not mix new batteries with old batteries or different kinds of batteries.
- To avoid corrosion, remove the batteries if the remote controller will not be used for a long time.
- Remove dead batteries immediately to avoid damage from corrosion. If the remote controller does not operate smoothly, remove the old batteries and replace them both with two new AA batteries.

Using the remote controller

Point the remote controller toward the remote control sensor. The STANDBY indicator lights up when the unit receives a signal from the remote controller.

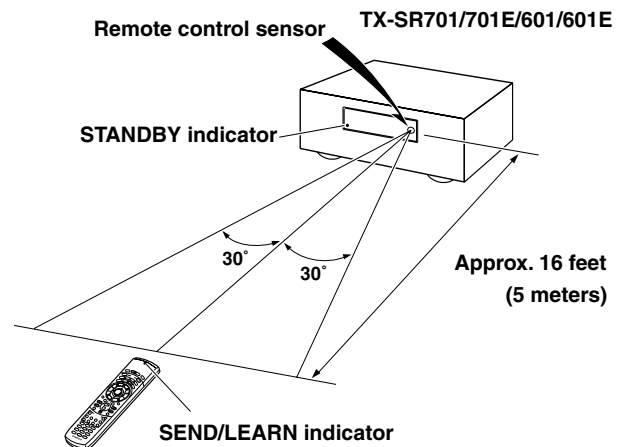

Notes:

- Make sure that the remote control sensor is not subject to strong light such as direct sunlight or inverted fluorescent light for it may prevent proper operation of the remote controller.
- Using another remote controller in the same room or using the TX-SR701/701E/601/601E near equipment that uses infrared rays may cause operational interference.
- Do not put objects on the remote controller. Its buttons may be pressed by mistake and drain the batteries.
- Make sure the audio rack doors do not have colored glass. Placing the TX-SR701/701E/601/601E behind such doors may prevent proper remote controller operation.
- If there is any obstacle between the remote controller and the remote control sensor, the remote controller will not operate.

Front panel facilities

Here is an explanation of the controls and displays on the front panel of the TX-SR701/701E/601/601E.

Front panel

<TX-SR701E>

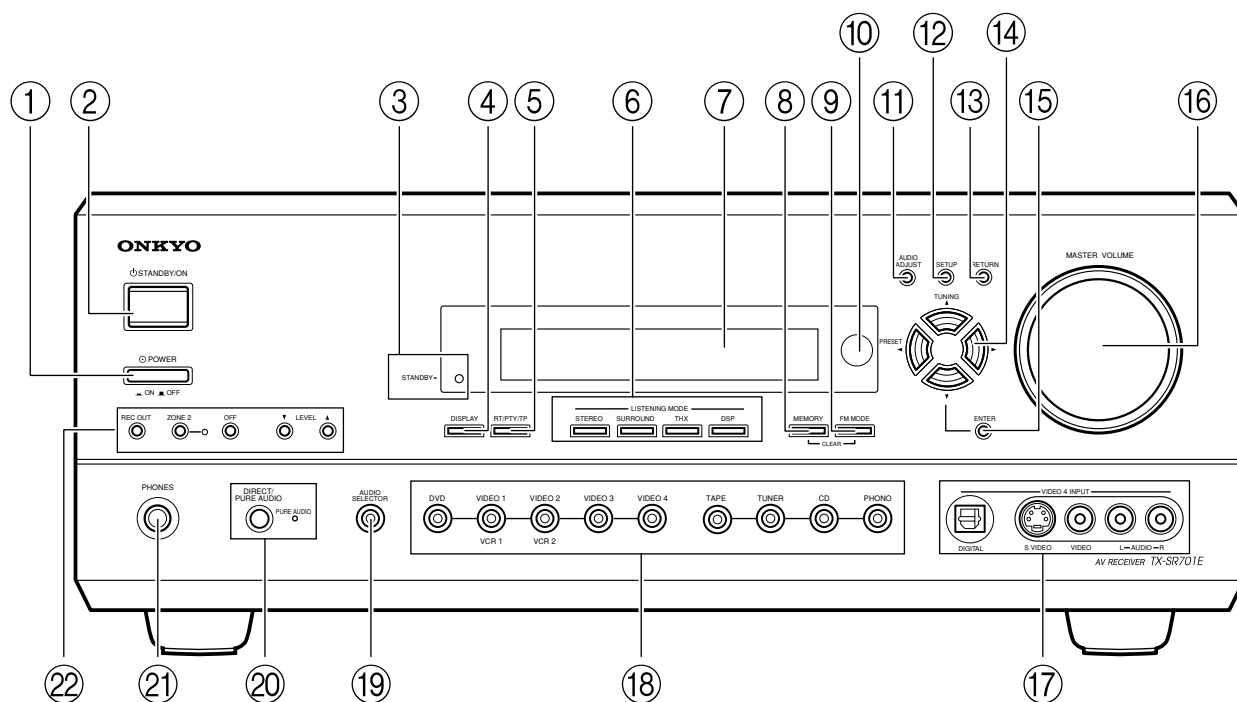

<TX-SR601E>

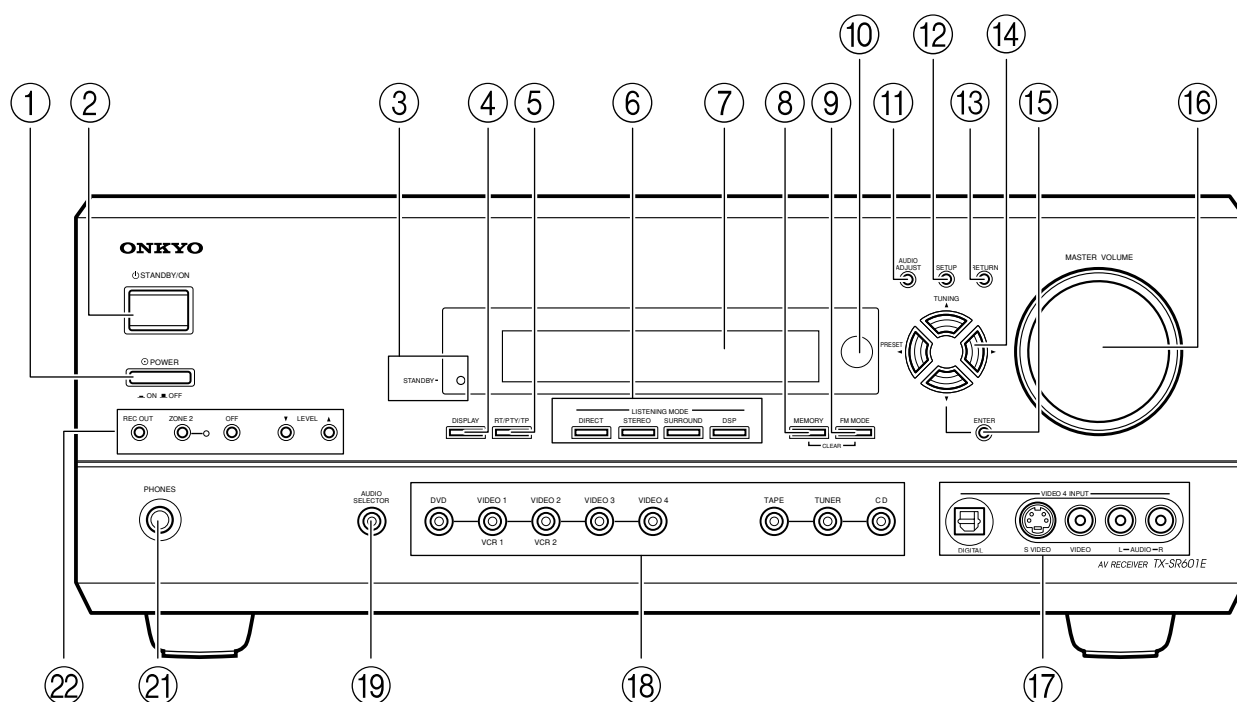

Front panel facilities

For further operational instructions, see the pages indicated in brackets [].

① **POWER switch (for all models other than USA and Canadian models, and Australian models) [28]**

Press to turn on and off the main power supply for the TX-SR701/701E/601/601E. When the TX-SR701/701E/601/601E is turned on with the POWER switch, the STANDBY indicator lights.

- Before turning on the power, check to make sure that all cords are properly connected.
- When the power is turned on, a sudden surge of current will occur that may adversely affect the operation of other devices. To prevent this, do not plug the TX-SR701/701E/601/601E into the same circuit used by sensitive equipment, e.g., computers.

② **STANDBY/ON button [28]**

If pressed with the POWER switch turned on (with the receiver plugged in for US models and Australian models), the TX-SR701/701E/601/601E turns on and the display lights up. If pressed again, the TX-SR701/701E/601/601E returns to the standby state. In the standby state, the display is turned off and the TX-SR701/701E/601/601E cannot be operated.

③ **STANDBY indicator [7, 28]**

Lights when the TX-SR701/701E/601/601E is in the standby state and when a signal is received from the remote controller.

④ **DISPLAY button [45]**

Press to display information about the current input source signal. Each time you press the display button, the screen changes to show you different information concerning the input signal.

⑤ **RT/PTY/TP (European models only) button [40]**

This button is only available on European models. Press this button to tune into the Radio Data System (RDS) for FM broadcasting. RDS was developed within the European Broadcasting Union (EBU) and is available in most European countries. Each time the button is pressed, the display changes from RT (radio text) to PTY (program type) to TP (traffic program) and then back to RT again.

⑤ **DIMMER button (other than European models)**

Press to set the brightness of the front display. There are three settings available: normal, dark, and very dark.

- The brightness of the front display can also be adjusted using the remote controller.

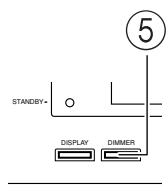

⑥ **LISTENING MODE buttons [46-51]**

Press these buttons to select a listening mode for the current input source. Press the DIRECT (TX-SR601/601E), THX (TX-SR701/701E), STEREO, and SURROUND buttons to select a listening mode directly. Press the DSP button to select any of the possible listening modes for the input source currently selected.

Note:

During playback of a multichannel source, press the DIRECT button to turn off the tone control and the SURROUND button to turn on the tone control. [45]

⑦ **Front display [11]**

⑧ **MEMORY button [38]**

Press to assign the radio station that you are currently tuned into to a preset channel or press to delete a previously preset station.

⑨ **FM MODE button [37]**

Press to change the stereo mode from AUTO to MONO and vice versa. Each time this button is pressed, the AUTO indication turns on and off indicating the current mode. If you are listening to an FM radio station in stereo and the sound cuts out or there is a great deal of noise, switch from AUTO to MONO.

⑩ **Remote control sensor [7]**

⑪ **AUDIO ADJUST button [57]**

Press to adjust the sound quality and the listening mode.

⑫ **SETUP button [31]**

Press to enter the Setup Menu. The OSD Menu will appear on the TV monitor as well as the front display on the TX-SR701/701E/601/601E.

⑬ **RETURN button [32]**

When in the Setup Menu, press to go back one level. If pressed while at the Main Menu, you will exit the Setup Menu.

⑭ **TUNING ▲/▼, PRESET ◀▶, cursor (▲/▼/◀▶) buttons [31, 37, 38]**

To tune into a radio station, press the TUNING ▲/▼ buttons. The tuner frequency is displayed in the front display and it can be changed in 100-kHz (or 50-kHz) increments for FM and 10-kHz (or 9-kHz) increments for AM.

When FM is selected as the input source, you can hold down either the TUNING ▲ or ▼ button and then release it to activate the auto-search feature. It will search for a station in the direction of the button you pressed and stop when it tunes into one. When navigating through the menu settings, these buttons move the cursor up or down (or change the highlighted item).

To select a radio station that was stored using the MEMORY button, press the PRESET ◀▶ buttons.

When navigating through the menu settings, these buttons select the value or item that you selected with the TUNING ▲/▼ buttons.

When you press the SETUP button, the TUNING and PRESET buttons become cursor buttons to be used for Setup Menu operations.

⑮ **ENTER button [31]**

Press to display the screen for the item that is selected in the Setup Menu.

⑯ **MASTER VOLUME dial [41]**

Use to control the volume in the main zone. The volume for the remote zone (Zone 2) is independent.

⑰ **VIDEO 4 INPUT terminals [21]**

For connecting a video camera or game device.

Front panel facilities

⑱ **Input source buttons (DVD, VIDEO 1–4, TAPE, TUNER, CD, and PHONO (TX-SR701/701E only)) [41]**

These buttons are used to select the input source.

Press these buttons to select the input source for the main zone.

To select the input source for the remote zone (Zone 2) or recording out (Rec Out), first press the ZONE 2 or REC OUT button, and then press the desired input source button. The input channel with its indicator lit red is output to REC OUT and the one with its indicator lit green is output to ZONE 2.

⑲ **AUDIO SELECTOR button [42]**

Press to select the type of audio input signal.

⑳ **DIRECT/PURE AUDIO button and indicator (TX-SR701/701E only) [46, 48]**

㉑ **PHONES jack [44]**

This is a standard stereo jack for connecting stereo headphones.

㉒ **REC OUT, ZONE 2, OFF, LEVEL ▼ / ▲ buttons, and ZONE 2 indicator [60, 61]**

The REC OUT and ZONE 2 buttons allow you to use the TX-SR701/701E/601/601E to output to a remote zone (Zone 2) or to another component for recording (Rec Out).

To turn off the output, press the OFF button. The ZONE 2 indicator lights when a signal is output to the remote zone (Zone 2). When the ZONE 2 indicator is off, then either output to the remote zone is turned off or Rec Out is selected. Press the LEVEL ▼ / ▲ buttons to enter the mode for adjusting the volume in the remote zone (Zone 2).

Note:

The Rec Out and Zone 2 buttons use the same circuit and therefore cannot be used at the same time. When REC OUT is selected, nothing is output to Zone 2. When ZONE 2 is selected, REC OUT is automatically fixed to SOURCE.

Front panel facilities

Front panel display

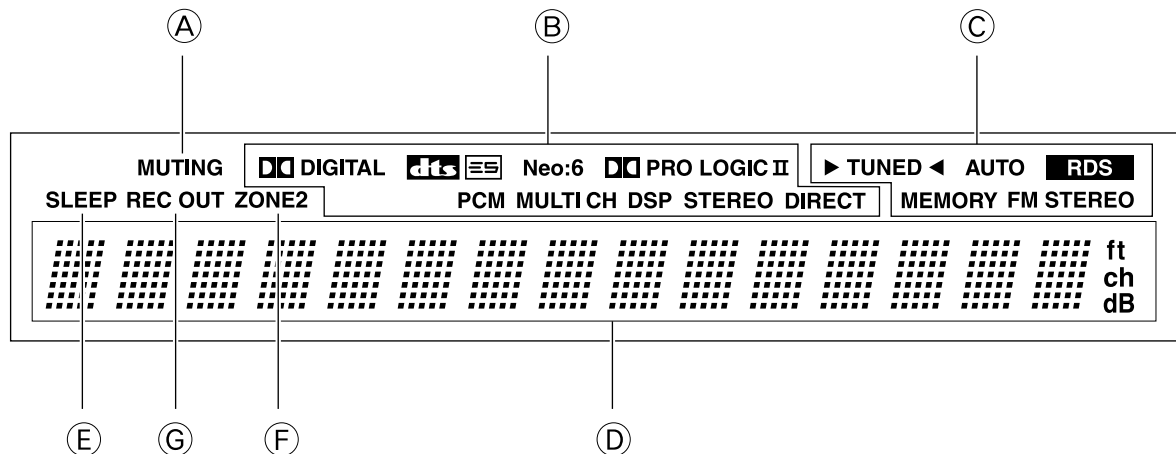

Ⓐ **MUTING indicator**

Flashes when the mute function is turned on.

Ⓑ **Listening mode or digital input format indicators**

One of these indicators lights to show the format of the current input source. In addition, one of the listening mode indicators lights to indicate the current listening mode.

Ⓒ **Tuning indicators**

TUNED indicator

Lights when a radio station is received.

AUTO indicator

Lights when receiving FM broadcasts in the stereo mode. Turns off when placed into the monaural mode.

RDS indicator (European models only)

Lights when an RDS station is received.

MEMORY indicator

Lights when the MEMORY button is pressed to preset a radio station.

FM STEREO indicator

Lights when an FM broadcast station is received in stereo.

Ⓓ **Multi function display**

During normal operation, shows the current input source and volume. When the FM or AM input is selected, shows the frequency and preset number. When the DISPLAY button is pressed, shows the listening mode and input source format. However, does not show the source format when the FM or AM source is selected.

Ⓔ **SLEEP indicator**

Lights when the sleep timer is turned on.

Ⓕ **ZONE 2 indicator**

Lights when using the remote zone (Zone 2).

Ⓖ **REC OUT indicator**

Lights when recording the input source from one component to another (Rec Out)

Remote controller

RC-533M

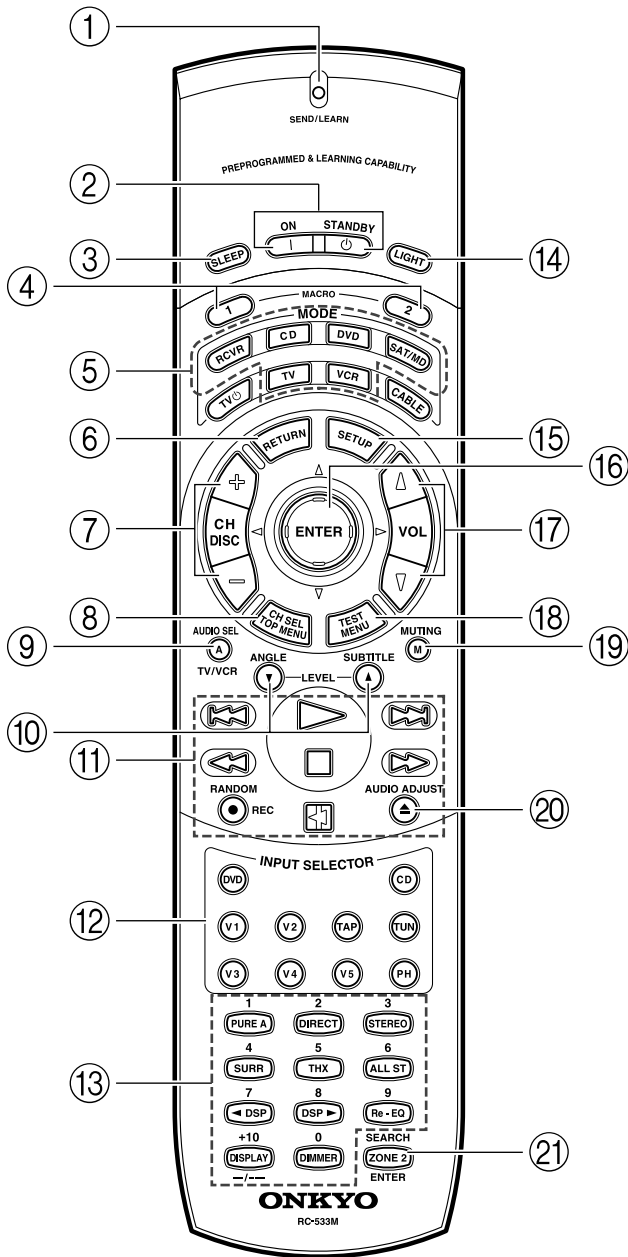

1 SEND/LEARN indicator

Lights red when signals are sent by the remote controller. It also flashes when a button is pressed when the battery power is low.

2 ON/STANDBY button [28]

ON: Press to turn on the TX-SR701/701E/601/601E.

STANDBY: Press to place the TX-SR701/701E/601/601E in the standby state.

Be aware that pressing the STANDBY button only places the TX-SR701/701E/601/601E in standby and does not turn the power completely off.

3 SLEEP button [44]

Press to set the sleep function.

The SLEEP button enables you to set the TX-SR701/701E/601/601E to turn off automatically after a specified time period.

4 MACRO 1, 2 button [73]

Press to program or execute the macro function.

5 MODE buttons and indicators [28, 63-74]

Press to select the component to be operated by the remote controller. When a MODE button is pressed, it will light for 8 seconds. The selected MODE button will also light whenever any other operation button is pressed.

6 RETURN button [32]

Press to enter the selected setting and return to the previous menu.

7 CH +/-, DISC +/- button

Press to select a preset channel for the tuner (CH). [38]

When the CD mode is selected, also press to select a disc when operating components with disc changers (DISC). [65]

8 CH SEL/TOP MENU button

Press to select a speaker channel when adjusting the speaker level (CH SEL). [43]

When the DVD mode is selected, press to display the menu screens of the DVD player (TOP MENU). [64]

9 AUDIO SEL/TV/VCR button [47]

Press to select the audio input signal. The setting changes from "Auto" to "Multich" (only if DVD is selected as the input source) to "Analog" and back each time this button is pressed.

10 LEVEL +/-/ANGLE and LEVEL +/-/SUBTITLE buttons

Press to adjust the volume of the speaker selected using the CH SEL button (LEVEL +/-). [43]

Press the ANGLE button to select a camera angle when playing a DVD-Video with multiple angle playback.

Press the SUBTITLE button to select a subtitle language when playing a DVD-Video. [64]

11 CD/TAPE/DVD/MD operation buttons [63-66]

Press to operate other Onkyo components connected to the TX-SR701/701E/601/601E using the **R I** terminals.

RC-515M

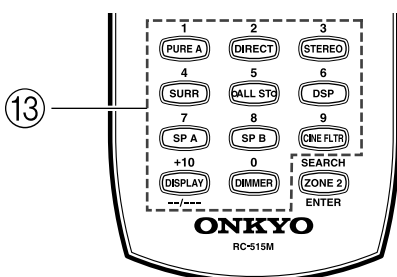

Remote controller

⑫ INPUT SELECTOR buttons [41]

Press to select an input source.

Same as the input selector buttons on the front panel of the TX-SR701/701E/601/601E. The input source for each button is given here. DVD:DVD, CD:CD, V1:VIDEO1, V2:VIDEO2, V3:VIDEO3, V4:VIDEO4, V5:VIDEO5 (not used with the TX-SR701/701E/601/601E), TAP:TAPE, TUN:FM/AM, PH:PHONO (not used with the TX-SR601/601E).

⑬ Numeric key/Listening mode, SP A, SP B, CINE FLTR, DISPLAY, DIMMER buttons

1 to 9, +10, --/--, 0: For entering the number of a track. [64-66]

PURE A:

TX-SR601/601E: Not used with the TX-SR601/601E.

TX-SR701/701E: Press to select the Pure Audio mode. [46, 48]

DIRECT, STEREO, SURR, ALL ST, DSP (TX-SR601/601E), DSP ◀/▶ (TX-SR701/701E), THX (TX-SR701/701E): You can select a listening mode. [48-51]

Note:

During playback of a multichannel source, press the DIRECT button to turn off the tone control and the SURR button to turn on the tone control.

SP A, SP B: Not used with the TX-SR601/601E.

CINE FLTR (TX-SR601/601E): Depending on the listening mode, you can turn the CinemaFILTER function on or off. [51]

Re-EQ (TX-SR701/701E): Depending on the listening mode, you can turn the Re-EQ function on or off. [49]

DISPLAY: For changing the display in the front display. [45]

DIMMER: Adjusts the display brightness.

There are three settings available: normal, dark, and very dark.

⑭ LIGHT button (RC-533M only)

Press to turn on and off the lights in the buttons of the remote controller.

⑮ SETUP button [31]

Press to display the Setup Menu on the TV screen and in the display. Press again to exit the menu.

⑯ ▲/▼/◀/▶, ENTER button [31]

When in the Setup Menu, press the upper and lower arrow buttons to select an item, press the right and left arrow buttons to select parameter values or modes, and press the ENTER button to advance to the next item.

⑰ VOL ▲/▼ button [41]

Press to adjust the volume.

⑱ TEST/MENU button

This button is used to set the speaker output levels. Use this button in conjunction with the LEVEL ▲/▼ and CH SEL buttons to calibrate the speakers levels without entering the Setup Menu. [43]

When the DVD mode is selected, press to display the DVD menu (MENU). [64]

⑲ MUTING button [45]

⑳ AUDIO ADJUST button [57]

㉑ ZONE 2/SEARCH/ENTER button

When the DVD mode is selected, press to find the specific section on a DVD where you want to start playback (SEARCH). [64]

When in the RCVR mode, press to perform operations on the remote zone (ZONE 2). [60]

When in the MD mode, press to enter the selected song (ENTER). [66]

Connections

- Be sure to always refer to the instructions that came with the component that you are connecting.
- Do not plug in the power cord until all connections have been properly made.
- For input jacks, red connectors (marked R) are used for the right channel, white connectors (marked L) are used for the left channel, and yellow connectors (marked V) are used for video connection.
- Insert all plugs and connectors securely. Improper connections can result in noise, poor performance, or damage to the equipment.

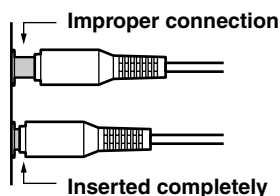

- Do not bind audio/video connection cables with power cords and speaker cables. Doing so may adversely affect the picture and sound quality.

Cables are depicted in the connection diagrams as shown below.

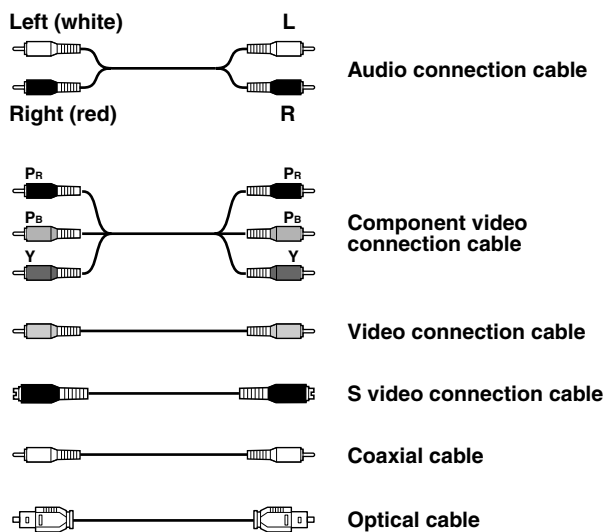

Connections

TX-SR701/701E

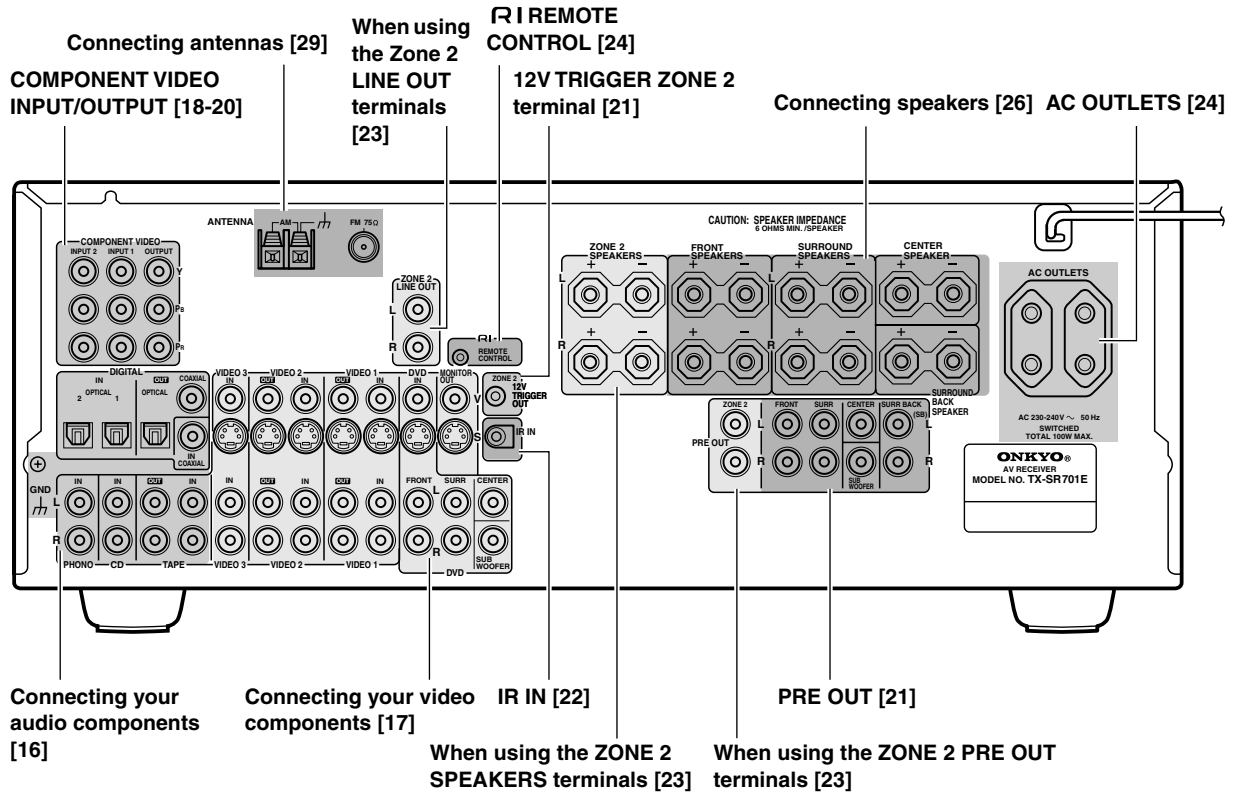

TX-SR601/601E

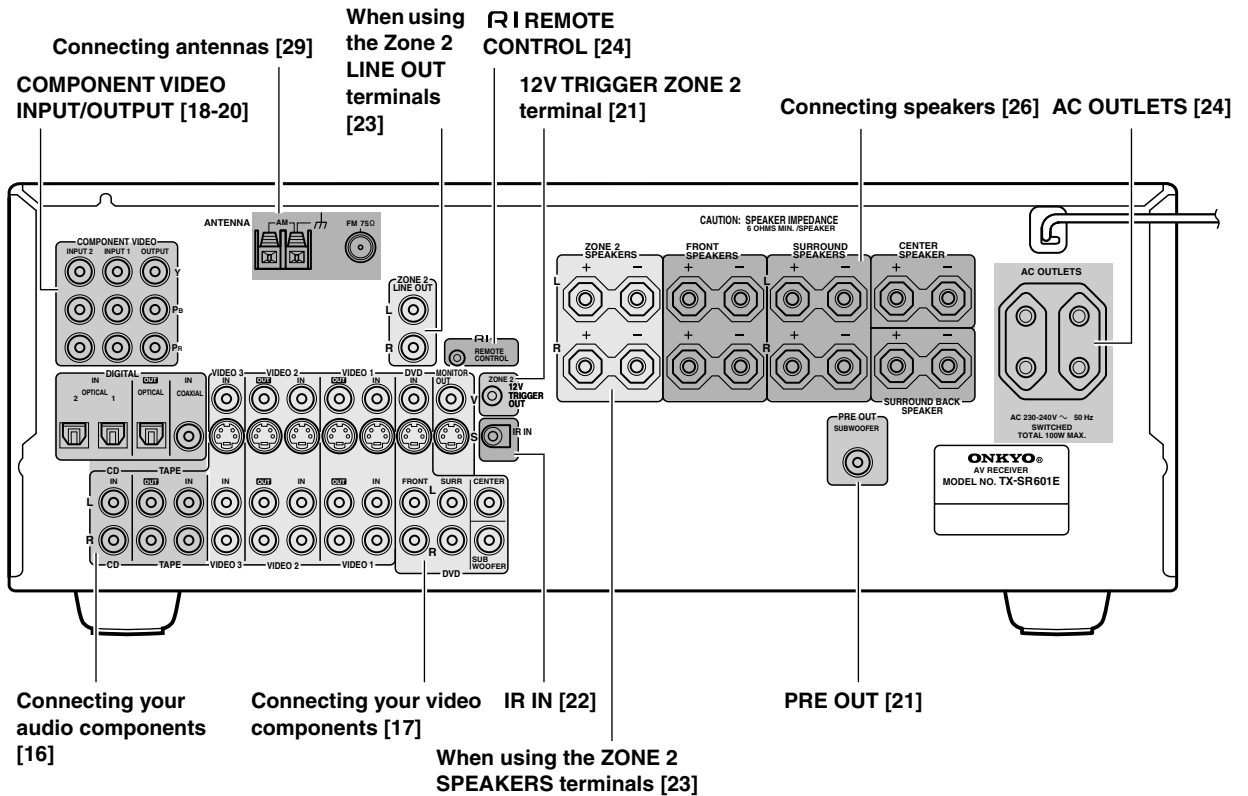

Connections

Here is an explanation of typical ways to connect various components to the TX-SR701/701E/601/601E. There are many ways that any one component can be connected, and it is up to you to decide which method best fits your situation. The directions given here are only one option and should only be thought of as such. It is best to fully understand the nature of each connector and terminal as well as those of your components and their features to ascertain which method of connection is best.

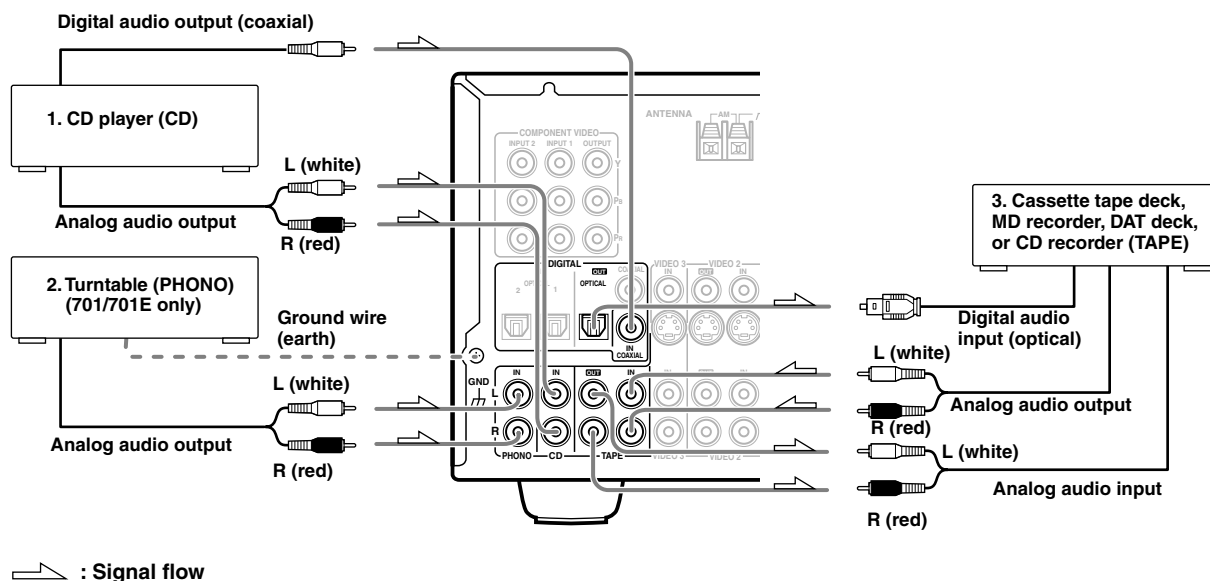

Connecting your audio components

Below is an example of how you can connect your audio components to the TX-SR701/701E/601/601E. Refer to the diagram above for the following connection examples.

IN/OUT (analog audio)

These are the analog audio inputs and outputs. There are seven audio inputs and three audio outputs on the rear panel. The audio inputs and outputs require RCA-type connectors.

DIGITAL INPUT/OUTPUT

On the rear panel of the TX-SR701/701E/601/601E, there are one coaxial digital input, two optical digital inputs, one coaxial digital output (TX-SR701/701E only), and one digital output. To the digital inputs, connect CD players, LD players, DVD players, or other digital source component. To the digital outputs, connect MD recorders, CD recorders, DAT decks, or other similar components.

- Since an analog connection must be made when using REC OUT or ZONE 2, make sure that the connection to the input source is not digital only, but analog as well.
- When using an optical input or output jack, always use an optical fiber cable.

1. Connecting a compact disc player (CD)

Using an RCA audio cable, connect the output jacks of the compact disc player to the CD audio jacks of the TX-SR701/701E/601/601E. Make sure that you properly connect the left channel to the L jack and the right channel to the R jack.

If the compact disc player has a digital output, connect it to either the DIGITAL INPUT COAXIAL jack or the DIGITAL INPUT OPTICAL jack of the TX-SR701/701E/601/601E depending on the type of connector on the compact disc player.

With the initial settings of the TX-SR701/701E/601/601E, the CD input source is set for digital input at the COAXIAL jack (COAX).

If the digital connection is made to a different jack, this must be changed at "Input Setup" → "Digital Input" (see page 52).

2. Connecting a turntable (PHONO) (TX-SR701/701E only)

Using an RCA audio cable, connect the output jacks of the turntable to the PHONO audio jacks of the TX-SR701/701E. Make sure that you properly connect the left channel to the L jack and the right channel to the R jack.

Note:

The TX-SR701/701E is designed for use with moving magnet cartridges. For proper operation, connect a ground (or earth) wire to the GND terminal. For some turntables, however, connecting the ground wire may cause increased noise, and in such a case, a ground wire is not necessary and should not be connected.

3. Connecting a cassette tape deck, MD recorder, DAT deck, or CD recorder (TAPE)

Using RCA audio cables, connect the output jacks (PLAY) of the device to the TAPE IN audio jacks of the TX-SR701/701E/601/601E and connect the input jacks (REC) of the device to the TAPE OUT audio jacks of the TX-SR701/701E/601/601E. Make sure that you properly connect the left channels to the L jacks and the right channels to the R jacks.

If the device has a digital output, connect it to either the DIGITAL IN COAXIAL jack or the DIGITAL IN OPTICAL jack of the TX-SR701/701E/601/601E depending on the type of connector on the device.

With the initial settings of the TX-SR701/701E/601/601E, nothing is allocated as the digital input source for TAPE (----).

If you connect the digital audio output, be sure to make the appropriate changes at "Input Setup" → "Digital Input" (see page 52).

If the device has a digital input, connect it to the DIGITAL OUTPUT jack of the TX-SR701/701E/601/601E for digital recording of the signal from the digital input of the TX-SR701/701E/601/601E.

Note:

The output from the DIGITAL OUT jack of the TX-SR701/701E/601/601E is only the digital signal input to the DIGITAL IN jack.

Connections

Connecting a DVD Player with 5.1-Channel Output

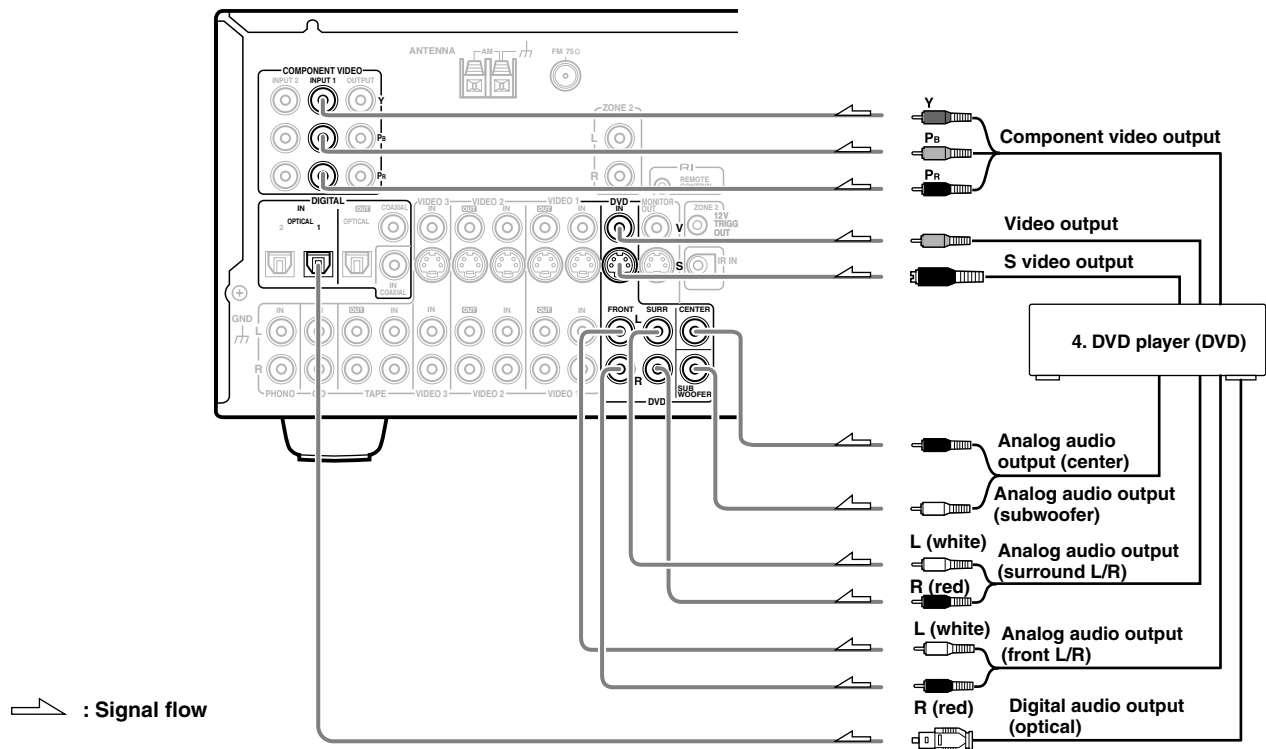

Connecting your video components

Below is an example of how you can connect your video components to the TX-SR701/701E/601/601E. Refer to the diagram above for the following connection examples.

Video signal will be output if you use any one of COMPONENT, S, or composite terminals. However, you are recommended to match the type of video terminals for connection between video devices (ex. DVD player and VCR), TX-SR701/701E/601/601E and TV/monitor.

COMPONENT VIDEO INPUT/OUTPUT

For DVD players or other devices that have component video connectors, the TX-SR701/701E/601/601E has two banks of component video input connectors (Y, PB, PR) for direct component video input. TX-SR701/701E/601/601E also has one bank of component video output connectors for direct component video output to the matrix decoder of a television, projector, or other display device. By sending the pure component video signal directly, the signal forgoes the extra processing that normally would degrade the image. The result is vastly increased image quality, with incredibly lifelike colors and crisp detail.

- The signal that comes in from COMPONENT VIDEO INPUT is only sent to COMPONENT VIDEO OUTPUT. When connecting a video player to the COMPONENT VIDEO INPUT jacks, be sure to connect your television to the COMPONENT VIDEO OUTPUT jacks.

VIDEO IN/OUT, S VIDEO IN/OUT

These are the video inputs and outputs. On the rear panel, there are four video inputs and two video outputs and each one includes both composite video and S video configurations.

Connect VCRs, VTRs, LD players, DVD players, and other video components to the video inputs. Connect VCRs, VTRs, and other recording components to the video outputs to make video recordings.

- When connecting a VCR or other video component, make sure you connect its audio and video leads to the same bank (e.g., both to VIDEO 3).
- The VIDEO 4 inputs are located on the front panel.

The flow of the video signals is as follows:

The signal that comes in from a VIDEO IN jack is sent to both the VIDEO OUT and S VIDEO OUT jacks. The signal that comes in from a S VIDEO IN jack is sent to both the S VIDEO OUT and VIDEO OUT jacks. It is not necessary to make both video and S video connections.

Notes:

- If your video output device (e.g., television or projector) is connected only to the MONITOR OUT VIDEO jack, MONITOR OUT S VIDEO jack, or both, and the video signal from the source component is input through the component video connectors, no picture will appear. Video sources input from the component video connectors can only be output from the component video connectors.
- For more information about the DIGITAL INPUT/OUTPUT jacks, see page 16.

Connections

Connecting a DVD Player with 2-Channel (L/R) Audio Output

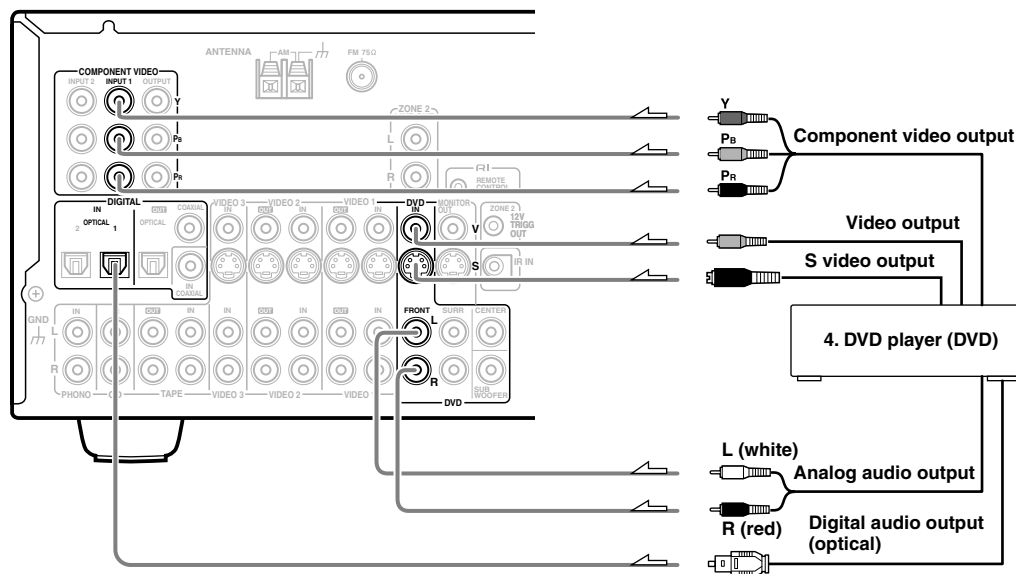

 : Signal flow

4. Connecting a DVD player (DVD)

Using an RCA video cable, connect the video output jack (composite) of the DVD player to the DVD V IN jack of the TX-SR701/701E/601/601E. Or if the DVD player has an S video output jack, connect it to the DVD S IN jack with an S video cable. Or if the device has component video outputs, connect them to the COMPONENT VIDEO INPUT 1 or 2 jacks on the TX-SR701/701E/601/601E.

With the initial settings of the TX-SR701/701E/601/601E, the DVD input source is set for the COMPONENT VIDEO INPUT 1 jacks.

If you connect the DVD player to the COMPONENT VIDEO INPUT 2 jacks, this must be changed at “Input Setup” → “Component Video” (see page 53).

Using an RCA audio connection cable, connect the audio output jacks of the DVD player to the DVD FRONT L/R jacks of the TX-SR701/701E/601/601E. Make sure that you properly connect the left channel to the L jack and the right channel to the R jack.

If the device has a 5.1-channel output, connect the DVD FRONT L/R, SURR L/R, CENTER, and SUBWOOFER (5.1-channel input) jacks of the TX-SR701/701E/601/601E to the 5.1-channel output jacks of the DVD player. Make sure that you properly connect the left channels to the L jacks and the right channels to the R jacks.

If the device has a digital output, connect it to either the DIGITAL IN COAXIAL jack or the DIGITAL IN OPTICAL jack of the TX-SR701/701E/601/601E depending on the type of connector on the DVD player.

With the initial settings of the TX-SR701/701E/601/601E, the DVD input source is set for digital input at the OPTICAL 1 jack (OPT 1).

If the digital connection is made at a different jack, this must be changed at “Input Setup” → “Digital Input” (see page 52).

Note:

If the DVD player has both 5.1-channel audio outputs and 2-channel audio outputs, and you want to connect the DVD player only using the FRONT L/R jacks on the TX-SR701/701E/601/601E, use the 2-channel audio output jacks on the DVD player.

Connections

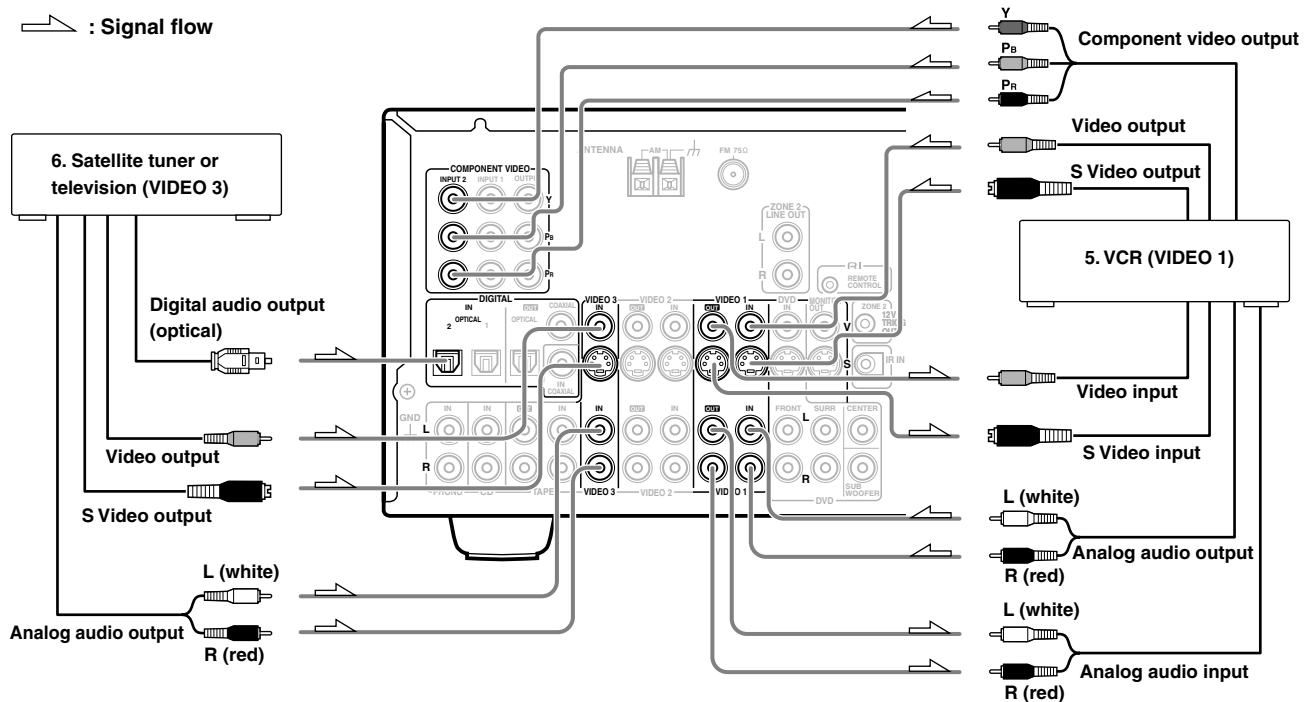

5. Connecting a video cassette recorder (VIDEO 1)

Using RCA video cables, connect the video output jack (composite) of the video cassette recorder to the VIDEO 1 V IN jack of the TX-SR701/701E/601/601E and connect the video input jack of the video cassette recorder to the VIDEO 1 V OUT jack of the TX-SR701/701E/601/601E. Or if the video cassette recorder has S video input and output jacks, using S video cables, connect the S video output jack of the video cassette recorder to the VIDEO 1 S IN jack of the TX-SR701/701E/601/601E and connect the video input jack of the video cassette recorder to the VIDEO 1 S OUT jack of the TX-SR701/701E/601/601E. Or if the video cassette recorder has component video outputs, connect them to the COMPONENT VIDEO INPUT 1 or 2 jacks on the TX-SR701/701E/601/601E.

With the initial settings of the TX-SR701/701E/601/601E, the VIDEO 1 input source is set for the COMPONENT VIDEO INPUT 2 jacks.

If you connect the video cassette recorder to the COMPONENT VIDEO INPUT 1 jacks, this must be changed at “Input Setup” → “Component Video” (see page 53).

Using RCA audio cables, connect the audio output jacks of the video cassette recorder to the VIDEO 1 IN audio jacks of the TX-SR701/701E/601/601E and connect the audio input jacks of the video cassette recorder to the VIDEO 1 OUT audio jacks of the TX-SR701/701E/601/601E. Make sure that you properly connect the left channels to the L jacks and the right channels to the R jacks.

If you are connecting a digital output device to the VIDEO 1 jack instead of a VCR, connect it to either the DIGITAL IN COAX jack or DIGITAL IN OPT jack depending on the type of connector on the device.

With the initial settings of the TX-SR701/701E/601/601E, nothing is allocated as the digital input source for VIDEO 1 (----). If you connect the digital audio output, be sure to make the appropriate changes at “Input Setup” → “Digital Input” (see page 52).

6. Connecting a satellite tuner, television, or settop box (VIDEO 3)

Using an RCA video cable, connect the video output jack (composite) of the device to the VIDEO 3 V IN jack of the TX-SR701/701E/601/601E. Or if the device has an S video output jack, connect it to the VIDEO 3 S IN jack of the TX-SR701/701E/601/601E using an S video cable. Or if the device has component video outputs, connect them to the COMPONENT VIDEO INPUT 1 or 2 jacks on the TX-SR701/701E/601/601E.

With the initial settings of the TX-SR701/701E/601/601E, the VIDEO 3 input source is set for the COMPONENT VIDEO INPUT 2 jacks.

If you connect the device to the COMPONENT VIDEO INPUT 1 jacks, this must be changed at “Input Setup” → “Component Video” (see page 53).

Using an RCA audio cable, connect the audio output jack of the device to the VIDEO 3 IN audio jacks of the TX-SR701/701E/601/601E. Make sure that you properly connect the left channel to the L jack and the right channel to the R jack.

If the device has a digital output, connect it to either the DIGITAL IN COAXIAL jack or the DIGITAL IN OPTICAL jack of the TX-SR701/701E/601/601E depending on the type of connector on the device.

With the initial settings of the TX-SR701/701E/601/601E, the VIDEO 3 input source is set for digital input at the OPTICAL 2 jack (OPT 2).

If the digital connection is made at a different jack, this must be changed at “Input Setup” → “Digital Input” (see page 52).

Connections

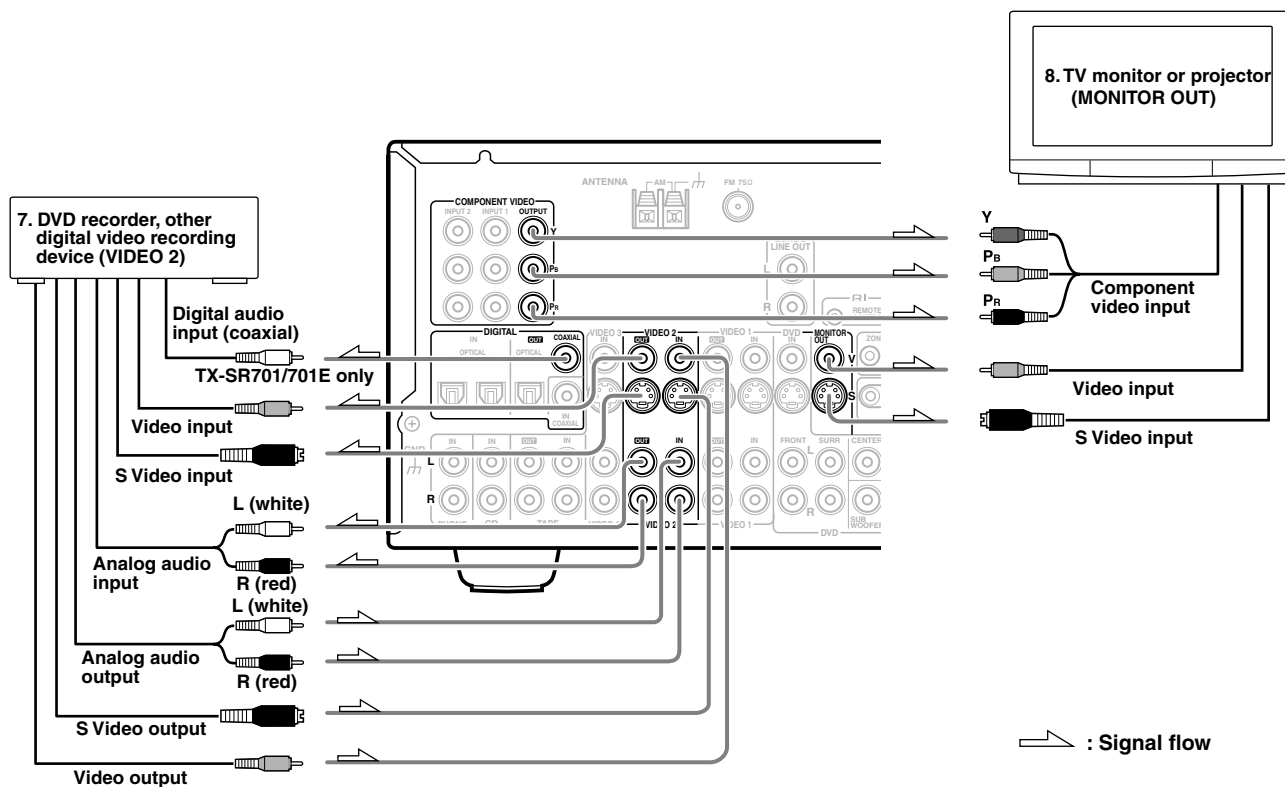

7. Connecting a DVD recorder or other digital video recording device (VIDEO 2)

Using RCA video cables, connect the video output jack (composite) of the device to the VIDEO 2 V IN jack of the TX-SR701/701E/601/601E and connect the video input jack of the device to the VIDEO 2 V OUT jack of the TX-SR701/701E/601/601E. Or if the device has S video input and output jacks, using S video cables, connect the S video output jack of the device to the VIDEO 2 S IN jack of the TX-SR701/701E/601/601E and connect the video input jack of the device to the VIDEO 2 S OUT jack of the TX-SR701/701E/601/601E. Or if the device has component video outputs, connect them to the COMPONENT VIDEO INPUT 1 or 2 jacks on the TX-SR701/701E/601/601E.

With the initial settings of the TX-SR701/701E/601/601E, the VIDEO 2 input source is set for the COMPONENT VIDEO INPUT 2 jacks.

If you connect the device to the COMPONENT VIDEO INPUT 1 jacks, this must be changed at "Input Setup" → "Component Video" (see page 53).

Using RCA audio cables, connect the audio output jacks of the device to the VIDEO 2 IN audio jacks of the TX-SR701/701E/601/601E and connect the audio input jacks of the device to the VIDEO 2 OUT audio jacks of the TX-SR701/701E/601/601E. Make sure that you properly connect the left channels to the L jacks and the right channels to the R jacks.

If the device has a digital output, connect it to either the DIGITAL IN COAXIAL jack or the DIGITAL IN OPTICAL jack of the TX-SR701/701E/601/601E depending on the type of connector on the device.

With the initial settings of the TX-SR701/701E/601/601E, nothing is allocated as the digital input source for VIDEO 2 (---).

If you connect the digital audio output, be sure to make the appropriate changes at "Input Setup" → "Digital Input" (see page 52).

If the device has a digital input, connect it to the DIGITAL OUTPUT jack of the TX-SR701/701E/601/601E for digital recording of the signal from the digital input of the TX-SR701/701E/601/601E.

Note:

The output from the DIGITAL OUT jack of the TX-SR701/701E/601/601E is only the digital signal input to the DIGITAL IN jack.

8. Connecting a television monitor or projector (MONITOR OUT)

The TX-SR701/701E/601/601E is equipped with a simple Y/C separate circuit and simple Y/C mixed circuit. Since both the signal from the S and V inputs are output to the MONITOR OUT S output, if the television or projector is equipped with an S video input, it is unnecessary to connect the video connectors. If it is equipped with only a video input, connect it to the MONITOR OUT V output.

Using an RCA video cable, connect the video input jack (composite) of the device to the MONITOR OUT V jack of the TX-SR701/701E/601/601E. Or if the device has an S video input jack, connect it to the MONITOR OUT S jack of the TX-SR701/701E/601/601E using an S video cable. Or if the device has component video inputs, connect them to the bank of COMPONENT VIDEO OUTPUT jacks on the TX-SR701/701E/601/601E.

Note:

Note that the Setup Menu will only be displayed on the monitor connected to MONITOR OUT (S or V) and not those connected to the COMPONENT VIDEO OUTPUT jacks.

Connections

9. Connecting video camera, etc. (VIDEO 4 INPUT)

Using an RCA video cable, connect the video output jack (composite) of the device to the VIDEO 4 VIDEO jack of the TX-SR701/701E/601/601E. Or if the device has an S video output jack, connect it to the VIDEO 4 S VIDEO jack of the TX-SR701/701E/601/601E using an S video cable.

Using an RCA audio cable, connect the audio output jack of the device to the VIDEO 4 AUDIO jacks of the TX-SR701/701E/601/601E. Make sure that you properly connect the left channel to the L jack and the right channel to the R jack.

If the device has an optical digital output, connect it to the VIDEO 4 DIGITAL jack of the TX-SR701/701E/601/601E.

The VIDEO 4 digital input is fixed to the OPTICAL input on the front panel.

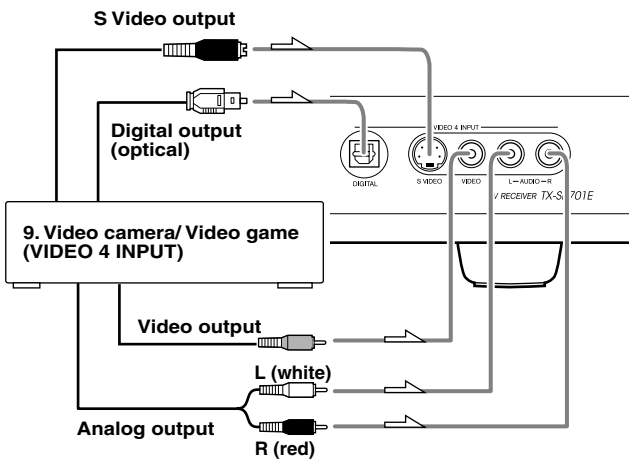

12V TRIGGER ZONE 2 terminal

When the TX-SR701/701E/601/601E is in the ZONE 2 mode, this terminal outputs at 12 V/100 mA.

PRE OUT (TX-SR701/701E only)

These jacks are for connecting an auxiliary power amplifier.

You can use an auxiliary power amplifiers to listen at louder volumes than you can with the TX-SR701/701E alone. When using a power amplifier, connect each speaker to the power amplifier.

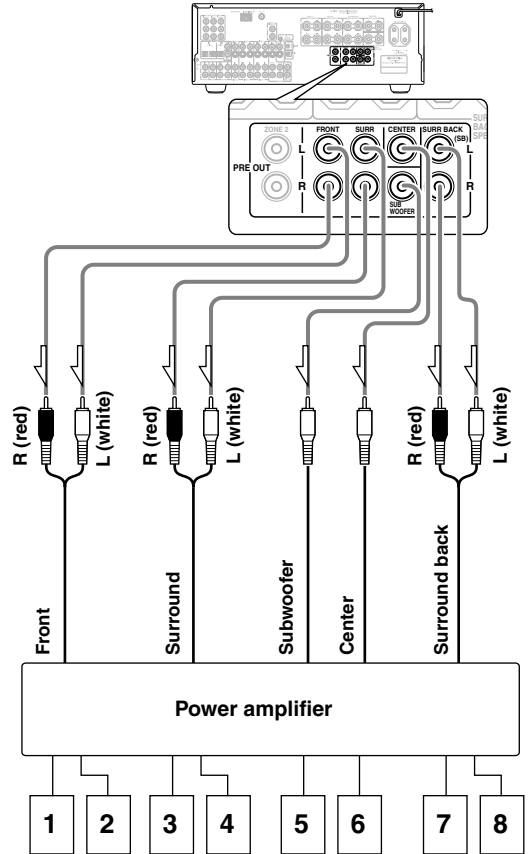

- | | |
|---------------------------|--------------------------------|
| 1. Front right speaker | 5. Subwoofer |
| 2. Front left speaker | 6. Center speaker |
| 3. Surround right speaker | 7. Surround back right speaker |
| 4. Surround left speaker | 8. Surround back left speaker |

Note:

If you use a power amplifier connected to the SURR BACK PRE OUT terminal and connect two surround back speakers to the amplifier, set the “Hardware Config” → “b. Surr Back” setting to “2ch (PRE OUT)” (see page 55).

Operating components not reached by the remote controller signals (IR IN)

In order to use the remote controller to control the TX-SR701/701E/601/601E from a remote location, you will need to prepare a multi-room kit (sold separately) such as one of those given below:

- Onkyo's Multi-Room System kit (IR Remote Controller Extension System)
- Multiroom A/V distribution and control system such as those from Niles® and Xantech®

If the remote controller signal does not reach the TX-SR701/701E/601/601E remote sensor

If the TX-SR701/701E/601/601E is located inside a cabinet or other enclosure where the infrared rays from the remote controller cannot enter, then operation with the remote controller will not be possible. In such a case, it will be necessary to install a remote sensor at a location outside of the cabinet where the infrared rays from the controller can reach.

With this connection, select "Main" at "Hardware Config" → "IR IN Position" (see page 55).

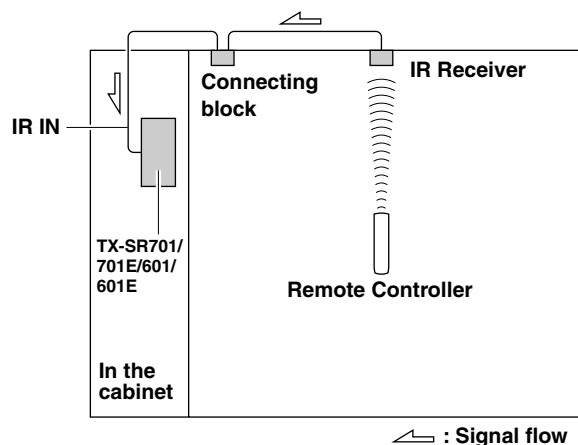

Make the connections as shown below. Do not plug in any equipment to the power outlet until all the connections are complete.

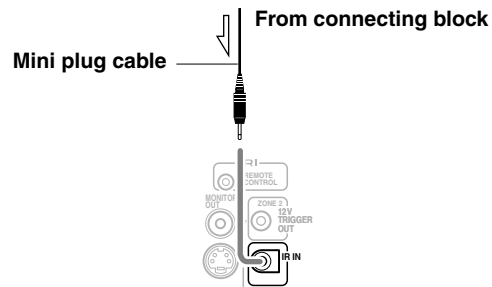

TX-SR701/701E/601/601E

The IR IN input allows you to control the TX-SR701/701E/601/601E from the remote zone (Zone 2) with the remote controller even though the remote zone may be on the other side of the building from the main zone. The diagram below shows how to make the proper connections for the remote zone.

With this connection, select "Zone 2" at "Hardware Config" → "IR IN Position" (see page 55).

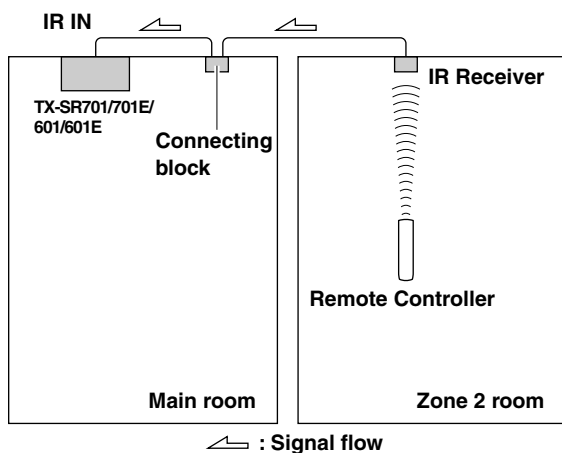

Connecting the remote zone (Zone 2) speakers

The TX-SR701/701E/601/601E allows you to listen to two separate input sources at the same time. This allows you to, for example, place speakers in two different rooms so that two or more people can enjoy two different kinds of music at the same time. The room where the TX-SR701/701E/601/601E is actually located is referred to as the main room while the separate room is referred to as the remote zone (Zone 2). In addition, the IR IN terminal of the TX-SR701/701E/601/601E allows you to control the TX-SR701/701E/601/601E from the remote zone (Zone 2) with the remote controller even though the remote zone is physically separated. The diagrams below show how to make the proper connections for the remote zone.

When using the ZONE 2 SPEAKERS terminals

You can connect the speakers for the remote zone (Zone 2) to the ZONE 2 SPEAKERS terminals. When you connect the speakers to the ZONE 2 SPEAKERS terminals, set the “Hardware Config” setting to “Zone 2.” In this setting, while you use the remote zone (Zone 2), surround playback will not be available for the main room (2ch stereo playback only). When you are not using the Zone 2, 6.1-channel playback will be available for the main room.

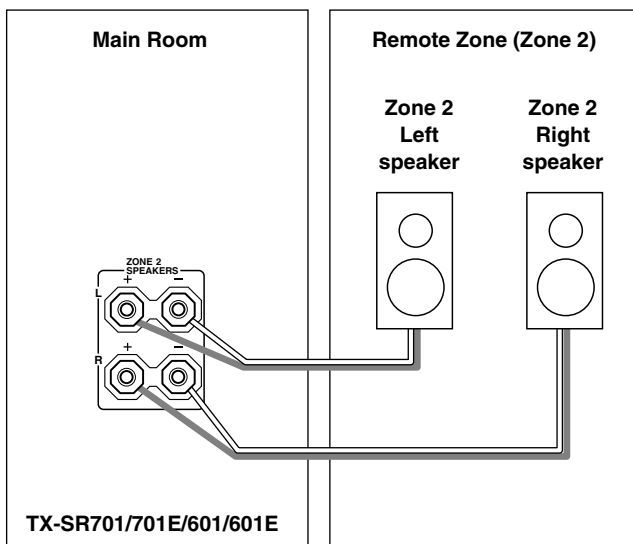

Note:

It is important to be aware of the speaker impedance (see page 31).

When using the ZONE 2 LINE OUT terminals

The ZONE 2 LINE OUT terminal is a constant output. Connect to the LINE input of the amplifier (CD, tape, etc.). Adjust the volume with the amplifier connected to the ZONE 2 LINE OUT terminal. In this connection, whatever the “Hardware Config” setting is set to, 6.1 channel playback is always available for main room.

1. Connect the TX-SR701/701E/601/601E to the amplifier for the remote zone.
2. Connect the remote zone speaker cables to the speaker terminals on the amplifier.

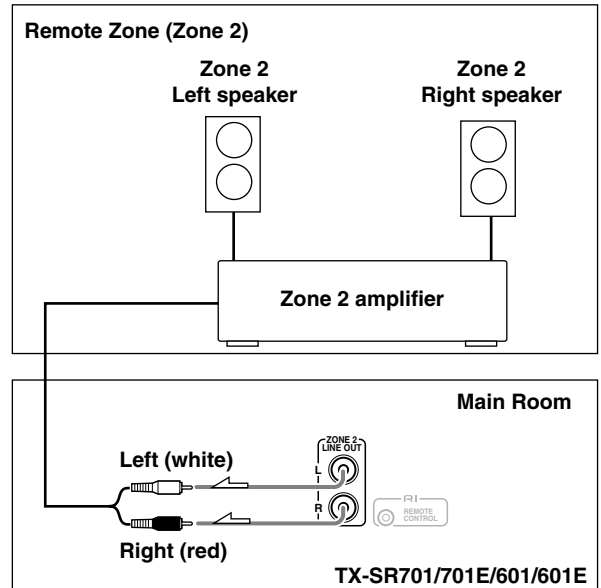

Note:

The ZONE 2 out terminals of the TX-SR701/701E/601/601E are of a fixed output level.

When using the ZONE 2 PRE OUT terminals (TX-SR701/701E only)

You can connect the amplifier for the remote zone (Zone 2) to the ZONE 2 PRE OUT terminals and connect the remote zone speakers.

When you connect the speakers to the ZONE 2 SPEAKERS terminals, set the “Hardware Config” setting to “Zone 2.” In this setting, while you use the remote zone (Zone 2), surround playback will not be available for the main room (2ch stereo playback only). When you are not using the Zone 2, 6.1-channel playback will be available for the main room.

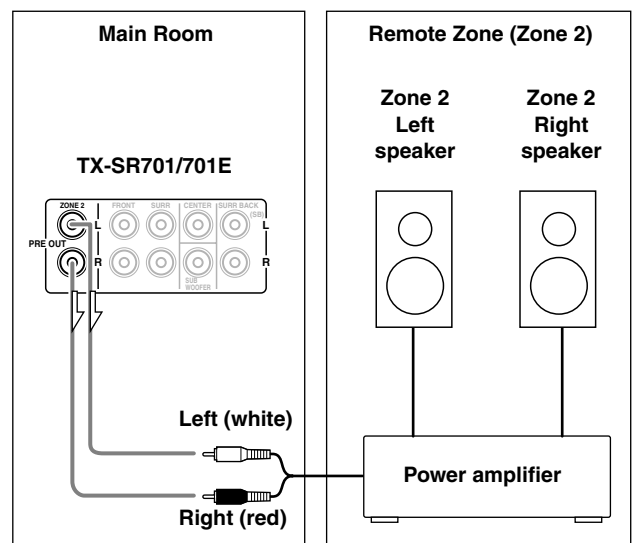

Connections

AC OUTLETS

The TX-SR701/701E/601/601E is equipped with AC mains outlets for connecting the power cords from other devices so that their power is supplied through the TX-SR701/701E/601/601E. By doing this, you can leave the connected device turned on and have the STANDBY/ON button on the TX-SR701/701E/601/601E turn on and off the device together with the TX-SR701/701E/601/601E.

The shape, number, and total capacity of the AC outlets may differ depending on the area of purchase.

Caution:

Make sure that the total capacity of the components connected to the TX-SR701/701E/601/601E does not exceed the capacity that is printed on the rear panel (e.g., TOTAL 120W).

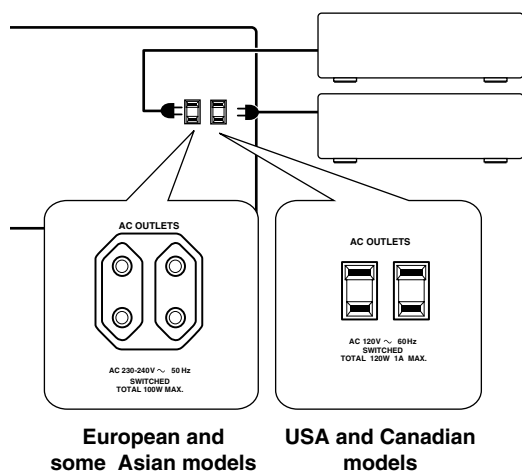

RI REMOTE CONTROL

The RI terminal on the TX-SR701/701E/601/601E is for connecting other Onkyo components equipped with the RI same terminal. When a component is connected to the terminal, it can be operated by the remote controller supplied with the TX-SR701/701E/601/601E. In addition, when you connect a component to the RI terminal, you can also perform the system operations given below.

Power on/ready function

When the TX-SR701/701E/601/601E is in the standby state, if an RI-connected component is turned on, the TX-SR701/701E/601/601E also turns on and the input source selected at the TX-SR701/701E/601/601E automatically switches to that component.

Be aware that this function will not work if the power cord for the -connected component is connected to the AC OUTLET on the TX-SR701/701E/601/601E, or if the TX-SR701/701E/601/601E has already been turned on.

Direct change function

When the play button is pressed at an RI-connected component, the input source selected at the TX-SR701/701E/601/601E automatically changes to that component.

Power off function

When the TX-SR701/701E/601/601E is placed in the standby state, all RI-connected components are also automatically put into the standby state.

Also, if you press the ON button on the TX-SR701/701E/601/601E remote controller while the TX-SR701/701E/601/601E is turned on, all RI-connected components (DVD players, CD players, MD recorders, tuners, etc.) are also turned on.

Dimmer function

The Dimmer function (display brightness adjustment) of the TX-SR701/701E/601/601E can be used to synchronize the display brightness on the connected device using the RI connection.

Caution:

If an MD recorder is connected to the TAPE jack on the TX-SR701/701E/601/601E, switch the Input Selector from TAPE to MD (see page 43).

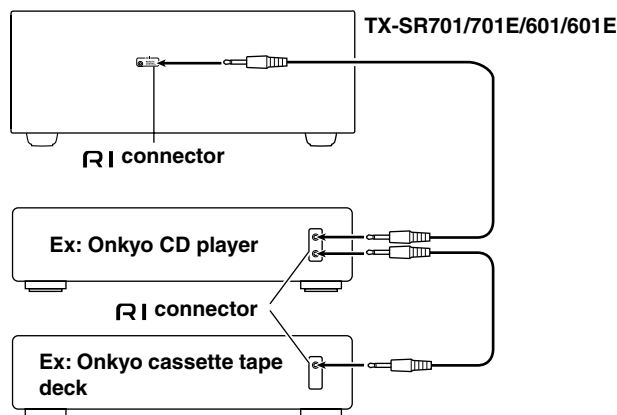

To connect components using the RI terminal, simply connect a remote control cable from this RI terminal to the RI terminal of the other component. An RI remote control cable with a 1/8-inch (3.5-mm) miniature two-conductor plug comes with every cassette tape deck, compact disc player, MD recorder, and DVD player that has an RI terminal.

- When performing operations with RI-connected components using the RI system, do not use the remote zone (Zone 2).
- For remote control operation, the audio connection cables must also be connected.
- If a component has two RI terminals, you can use either one to connect to the TX-SR701/701E/601/601E. The other one can be used to daisy chain with another component.
- With Onkyo DVD players, you can enter the pre-program code so that you can operate the DVD player directly with the remote controller without connecting the RI terminals (see page 67).

Connecting speakers

Before connecting the speakers, it is very important to place them properly for the optimum sound space for your listening pleasure. Be sure to refer to the instruction manuals that came with the speakers during placement and connection. Furthermore, be aware that for surround playback, the configuration and placement of your speakers are both very important.

Standard speaker setup for surround sound

- **Front right and left speakers**
Produces a basic sound image.
- **Center speaker**
Produces a rich sound image by serving as a sound source for the front right and left speakers and enhancing the sonic movement.
- **Surround right and left speakers**
Adds three-dimensional sonic movement and produces environmental sound associated with the background and effect sound for each scene.
- **Surround back speaker**
Required for enjoying Dolby Digital EX, THX Surround EX (TX-SR701/701E only), or DTS-ES audio. Improves the quality of sound effects and the realistic acoustics.
- **Subwoofer**
Produces powerful and heavy bass.

Minimum speaker configuration for surround sound playback

- **Front right and left speakers**
- **Surround right and left speakers**

The sound recorded for the center speaker and the subwoofer will be properly distributed to the front right and left speakers for optimized surround playback.

Speaker placement

Ideal speaker placement varies depending on the size of your room and the wall coverings. Here, only typical examples of speaker placement and recommendations are shown.

Important points regarding speaker placement

Front left and right speakers and center speaker

- Place these three speakers all at the same height.
- Place each speaker so that it is aimed at the location of the listener's ears when at the listening position.
- Place front left and right speakers at the same distance from the listening position.

Surround left and right speakers

Place these speakers so that their height is 3 feet (1 meter) higher than that of the listener's ears.

Surround back speakers

- Place these speakers so that their height is 3 feet (1 meter) higher than that of the listener's ears.
- (TX-SR701/701E only) When using surround back left and right speakers, place them behind the listener so that the angles between the lines from each speaker to the listener and a line straight back from the listener are less than 30 degrees.

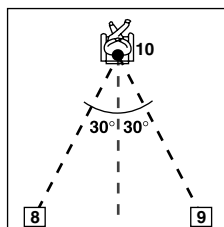

Subwoofer

When bass sound is reproduced, its volume and quality greatly depend on subwoofer placement. Those characteristics also depends on the shape of your listening room as well as your listening point. Generally speaking, good bass sound is obtained when the subwoofer is placed in the corner of the room or at one-third the length of the room.

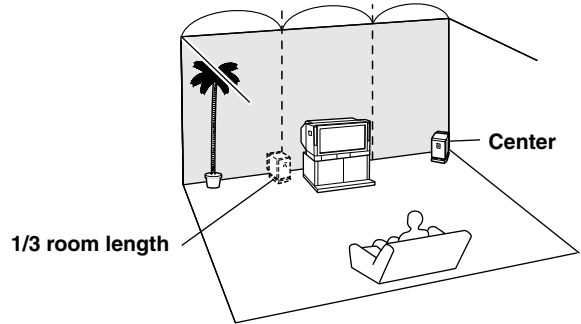

(Only one surround back speaker)

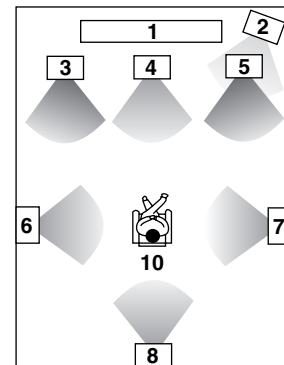

(Two surround back speakers (TX-SR701/701E only))

Layout with dipolar speakers

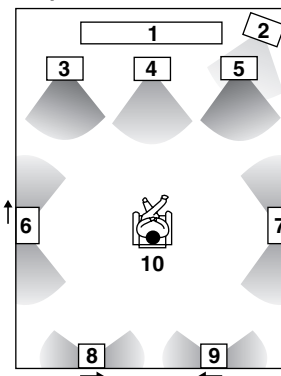

Layout with monopolar speakers

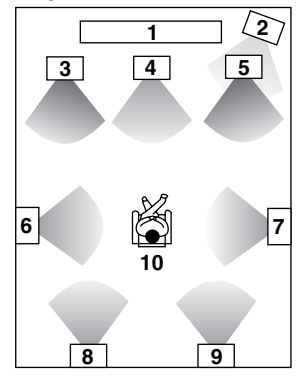

1. TV or screen
2. Subwoofer
3. Front left speaker
4. Center speaker
5. Front right speaker
6. Surround left speaker
7. Surround right speaker
8. Surround back speaker (or Surround back left speaker)
9. Surround back right speaker
10. Listening position

Most dipoles have an arrow on them to indicate their orientation in which that should be placed. For the correct acoustical phasing in the room, dipolar surround speakers should be placed so that their arrows point forward toward the screen and dipolar surround speakers should be placed so that their arrows point to each other.

Connecting speakers

Using the speaker cable labels

The positive speaker terminals on the TX-SR701/701E/601/601E are color coded for easy identification. Attach the supplied speaker labels to the speaker cables, and then match the colors on the speaker cables to the corresponding terminals.

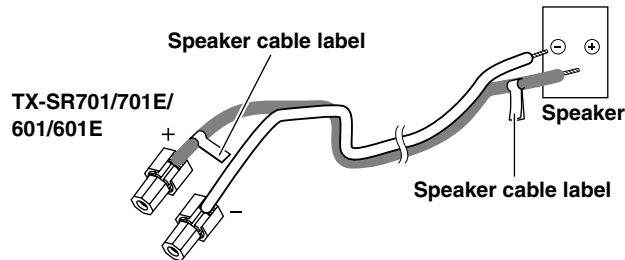

The speaker channels are colored as follows:

- Front left speaker (+): White
- Front right speaker (+): Red
- Center speaker (+): Green
- Surround left speaker (+): Blue
- Surround right speaker (+): Grey
- Surround back speaker (+): Brown
- Zone 2 left speaker (+): White
- Zone 2 right speaker (+): Red

Note:

If you select “2ch (PRE OUT)” at the “1. Hardware Config” menu → “ b. Surr Back” and use the PRE OUT terminals for 7.1ch sound, connect the speakers to the power amplifier connected to the PRE OUT terminals without connecting any speakers to the Surround Back Speaker terminals on the TX-SR701/701E. Using the surround back terminals on both the TX-SR701/701E and power amplifier will not produce correct surround sound effect (see page 55).

Connecting a subwoofer

Use the SUBWOOFER PRE OUT jack to connect a subwoofer with a built-in power amplifier. If your subwoofer does not have a built-in amplifier, connect an amplifier to the SUBWOOFER PRE OUT jack and the subwoofer to the amplifier.

Connecting the surround back speakers (TX-SR701/701E only)

If you connect the surround back speakers to the power amplifier connected to the SURR BACK PRE OUT terminals on the TX-SR701/701E for 7.1ch sound playback, do not connect the surround back speakers to the SURROUND BACK SPEAKER terminals on the TX-SR701/701E. Connecting the surround back speakers to both the TX-SR701/701E and power amplifier will not produce correct surround sound effect.

Connecting speakers

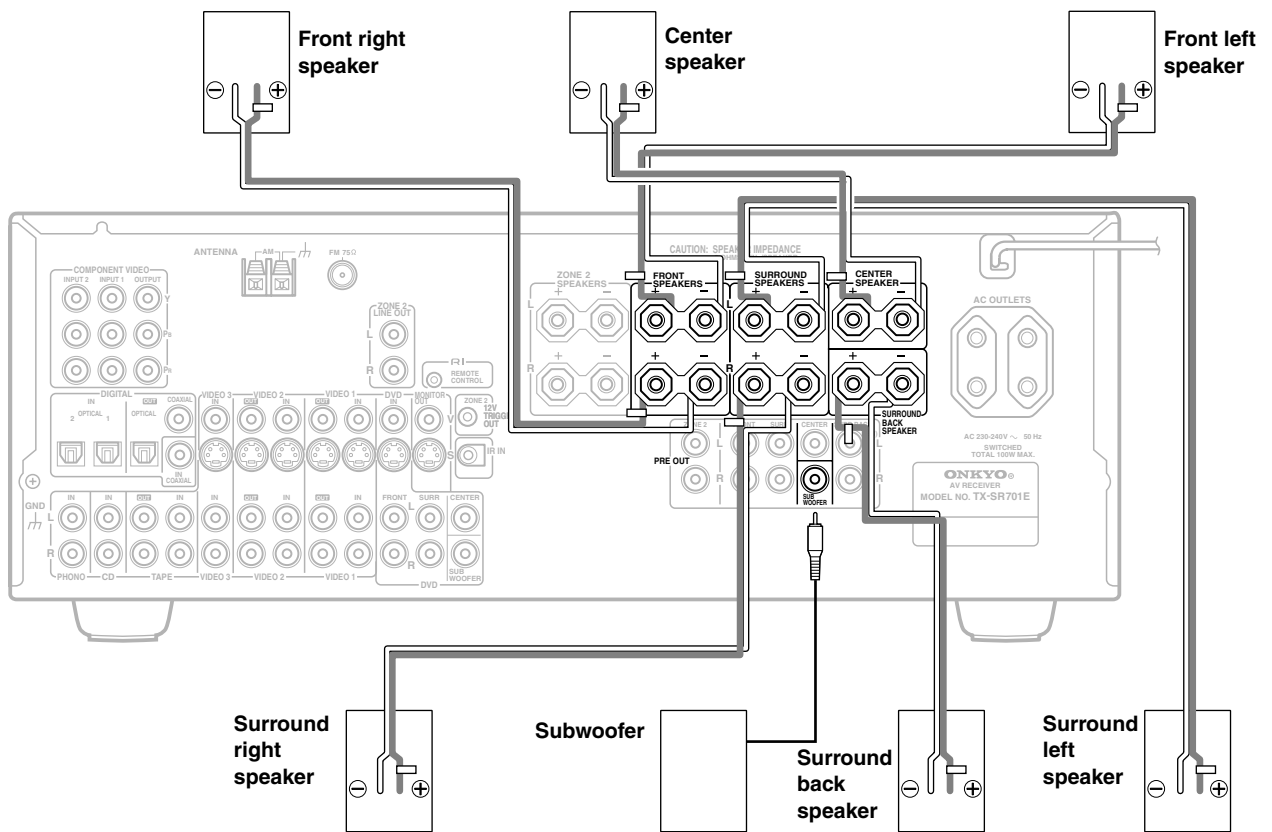

Connecting speakers

After determining the layout of your speaker system, it is now necessary to connect the speakers correctly to your TX-SR701/701E/601/601E.

Caution:

- Be sure to connect the positive (+) and negative (-) cables for the speakers properly. If they are mixed up, the left and right signals will be reversed and the audio will sound unnatural.
- Do not connect more than one speaker cable to one speaker terminal. Doing so may damage the TX-SR701/701E/601/601E.
- **Connect only speakers with an impedance between 6 and 16 Ω to the TX-SR701/701E/601/601E. Connecting speakers with an impedance lower than 6 Ω may damage the amplifier.**
- Even if you are using only one speaker or listening to monaural (mono) sound, never connect a single speaker in parallel to both the right and left-channel terminals.

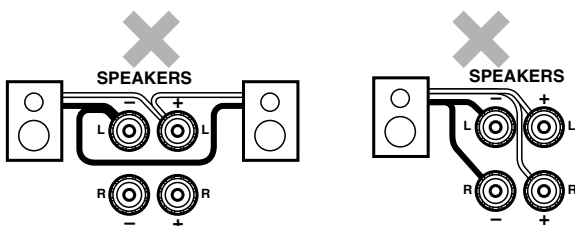

- To prevent damage to circuitry, never short-circuit the positive (+) and negative (-) speaker wires.

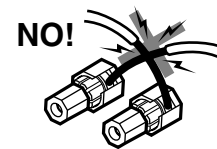

Connecting the speaker cable

1. Strip away approx. 5/8 inch (15 mm) of the wire insulation.
2. Twist the wire ends tightly together.
3. Unscrew the speaker terminal cap.
4. Insert the exposed wire end.
5. Screw down the speaker terminal cap.

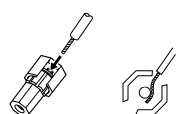
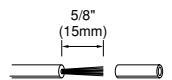

Connecting the power

Diagram for TX-SR701/701E

(USA and Canadian models and Australian models)

STANDBY/ON

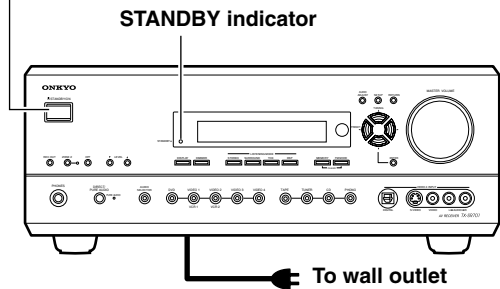

(All models other than USA and Canadian models and Australian models)

STANDBY/ON

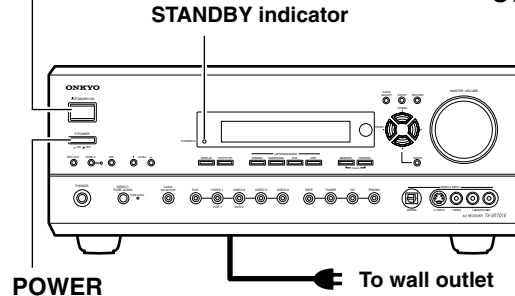

Diagram for RC-533M

ON
STANDBY
RCVR
MODE



- Turning on the power may cause a momentary power surge, which might interfere with other electrical equipment on the same circuit, such as computers. If this happens, use a wall outlet on a different circuit.

(All models other than USA and Canadian models and Australian models)

- The TX-SR701/701E/601/601E is shipped with the main power (POWER) switch in the on position (ON). When the power cord is plugged in for the first time, the TX-SR701/701E/601/601E will automatically enter the standby state and the STANDBY indicator will light (same condition after step 2 below).

Turning on the power

- Plug the power cord into an AC wall outlet.

(USA and Canadian models and Australian models)

The STANDBY indicator will light up.



(All models other than USA and Canadian models and Australian models)

Press the POWER switch to set the TX-SR701/701E/601/601E to standby state.

The STANDBY indicator will light up.



- Press the STANDBY/ON button to turn on the TX-SR701/701E/601/601E.

The display will light up and the STANDBY indicator will turn off.

If you press the STANDBY/ON button again, the receiver returns to standby state.



Turn off



Turning on the power from the remote controller

Before you can use the remote controller, you must perform step 1 above and place the TX-SR701/701E/601/601E in the standby state.

- Press the RCVR MODE button.

The RCVR MODE button lights.



- Press the ON button to turn on the TX-SR701/701E/601/601E (take it out of the standby state).

To return the TX-SR701/701E/601/601E to the standby state, press the STANDBY button.

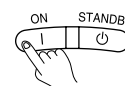

Memory preservation (Other than USA and Canadian models and Australian models)

The TX-SR701/701E/601/601E does not require memory preservation batteries. A built-in memory backup system preserves the contents of memory (e.g., speaker settings and surround settings) during power failures and even when the power is turned off with the POWER switch. The backup system is charged when the POWER switch is turned on.

The length of time that the memory will be preserved will vary depending on the ambient climate. On the average, memory contents are protected over a period of a few weeks after the last time the unit has been turned off. This period may be shorter when the unit is exposed to a highly humid climate.

Memory preservation (USA and Canadian models and Australian models)

The TX-SR701/701E/601/601E does not require memory preservation batteries. A built-in memory backup system preserves the contents of memory (e.g., speaker settings and surround settings) during power failures and even when the unit is unplugged. The unit must be plugged in order to charge the back-up system.

The length of time that the memory will be preserved will vary depending on the ambient climate. On the average, memory contents are protected over a period of a few weeks after the last time the unit has been unplugged. This period may be shorter when the unit is exposed to a highly humid climate.

Connecting antennas

To use the tuner of the TX-SR701/701E/601/601E, it is necessary to prepare the supplied FM and AM antennas.

- Adjustment and placement of the FM and AM antennas for better reception must be done while listening to a station broadcast.
- If better reception cannot be obtained, then placement of an outside antenna is recommended.

Assembling the AM loop antenna

Assemble the loop antenna as shown in the illustration.

- Refer to “Connecting the AM loop antenna” below for details on how to connect the loop antenna.

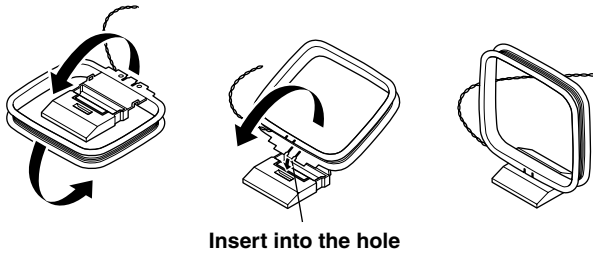

Connecting the AM antenna cable

1. Press down the lever at the antenna terminal.
2. Insert the wire into the terminal hole.
3. Release the lever.

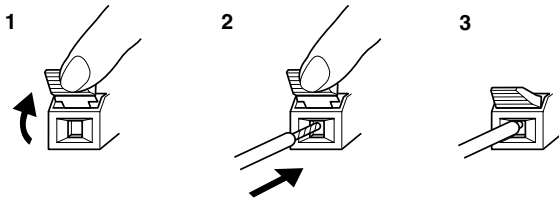

Connecting the included antennas

Connecting the FM indoor antenna:

The FM indoor antenna is for indoor use only. During use, extend the antenna and adjust its orientation until the clearest signal is received. Fix it with push pins or similar items in the position that will cause the least amount of distortion.

If the reception is not very clear with the attached FM indoor antenna, the use of an outdoor antenna is recommended.

Connecting the AM loop antenna:

The AM loop antenna is for indoor use only. Set it in the direction and position where you receive the clearest sound. Put it as far away as possible from the TX-SR701/701E/601/601E, televisions, speaker cables, and power cords.

If the reception is not very clear with the attached AM indoor antenna, the use of an outdoor antenna is recommended.

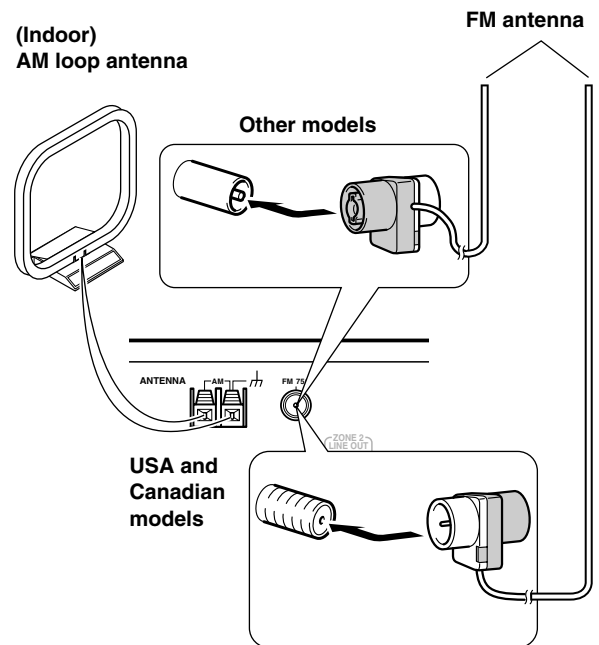

Hint:

Either of the split ends of the AM antenna can be connected to either terminal. Unlike speaker cabling, there is no polarity for AM broadcast signals.

Connecting antennas

Connecting an FM outdoor antenna

Make sure to follow the general rules given below:

- Keep the antenna away from noise sources (neon signs, busy roads, etc.).
- It is dangerous to put the antenna close to power lines. Keep it well away from power lines, transformers, etc.

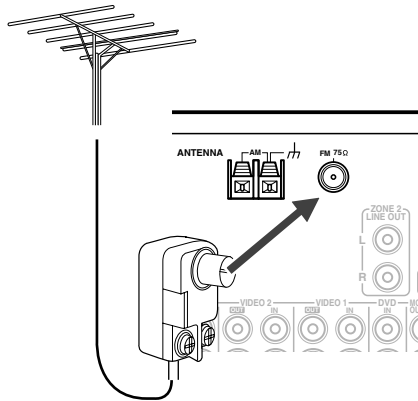

Connecting an AM outdoor antenna

If reception is poor with the indoor AM antenna, stretch out the outdoor antenna (16 feet (5 meters) or more) above a window or outside.

- Keep the indoor AM loop antenna connected. Do not remove it.

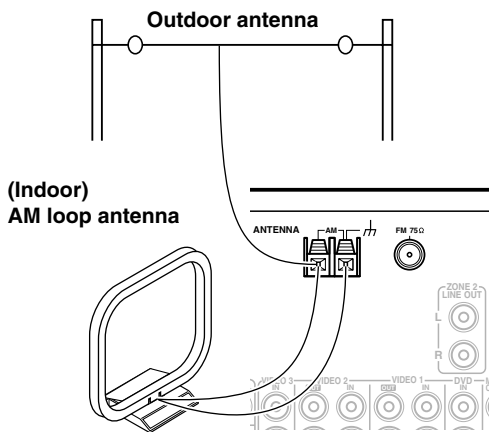

Note:

If you are using the TX-SR701/701E/601/601E worldwide model in a region where AM frequencies are delineated by 10-kHz steps, be sure to set the “AM Frequency Step” Setup setting accordingly (see page 55).

Directional linkage

Do not use the same antenna for both FM and TV (or VCR) reception since the FM and TV (or VCR) signals can interfere with each other. If you must use a common FM/TV (or VCR) antenna, use a directional linkage type splitter.

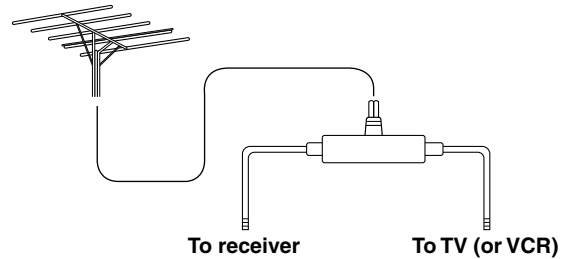

Connecting the antenna cable to the 75/300 Ω antenna adapter (For all models other than USA & Canadian models and European models)

Connecting the 300 Ω ribbon wire:

Loosen the screws on the adapter and wrap the wires of the ribbon wire around these screws. Then tighten the screws down with a screwdriver.



Connecting the coaxial cable:

1. With your fingernail, or a small screwdriver, press the stoppers of the 75/300 Ω antenna adapter outward and remove the cover.
2. Remove the transformer wire A from slit B and insert it into slit C.
3. Prepare the coaxial cable as shown in the diagram.
4. Connect the 75/300 Ω antenna adapter to the coaxial cable.

1. Insert the end of the cable.
2. Clamp it in place with pliers.

3. Reinstall the cover.

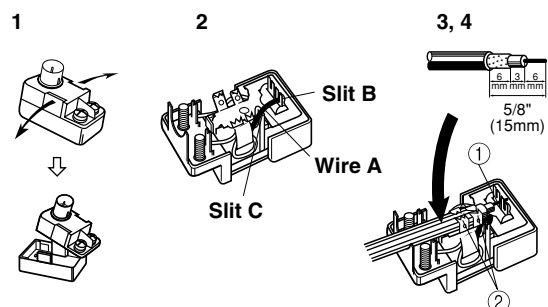

Configuring the speakers

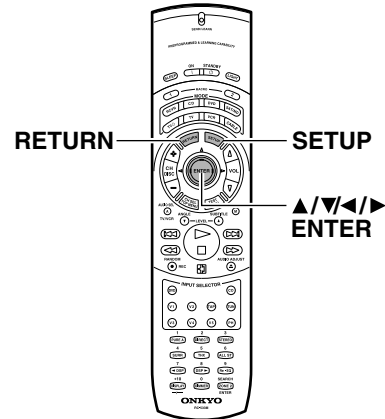
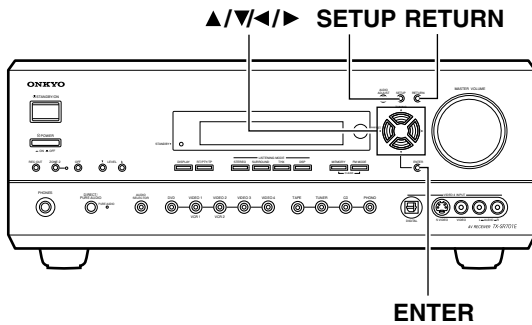

To create the optimum sound space for both visual and audio pleasure, it is necessary to set the size of the speakers and their distance from your normal listening position. Once made, you will not need to change these settings unless you change the speaker configuration or positions. Once you have connected the speakers, complete the following settings using the OSD Setup menu* before using the speakers.

*OSD Setup Menu

The OSD (On Screen Display) Setup Menu is displayed on the TV or projector monitor connected to the TX-SR701/701E/601/601E. It is used to configure the various settings of the TX-SR701/701E/601/601E for optimum performance.

Speaker Configuration

For your reference to speaker size settings, if the diameter of your speaker unit is larger than 6-1/2" (16 cm), use the "Large" setting; otherwise use the "Small" setting.

1. Display the main menu.
2. Use the ▲ and ▼ cursor buttons to select "1. Speaker Config."

Displaying the Main Menu

1. Display the main menu.

Press the SETUP button on the front panel or on the remote controller to display the main menu (Menu) on the monitor and front display.

TX-SR701/701E/601/601E **Remote controller**

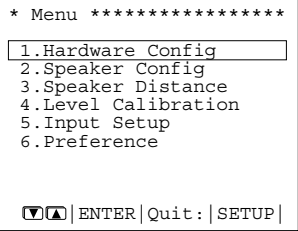

TX-SR701/701E/601/601E

Remote controller

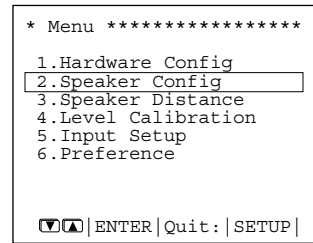
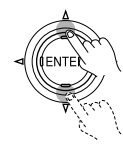
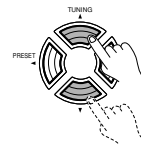

3. Press the ENTER button.

TX-SR701/701E/601/601E

Remote controller



The speaker configuration menu appears.

TX-SR701/701E

TX-SR601/601E

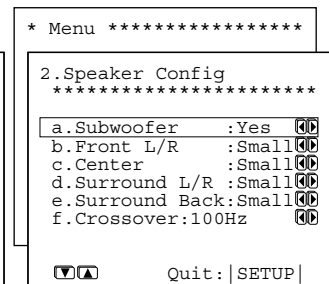
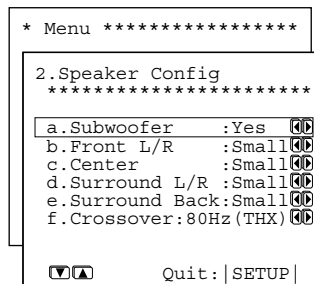

Configuring the speakers

4. Use the ▲ and ▼ cursor buttons to select “Subwoofer” and then use the ◀ and ▶ cursor buttons to select the subwoofer setting.

Yes: Select when a subwoofer is connected.

No: Select when a subwoofer is not connected.

TX-SR701/701E/601/601E

Remote controller

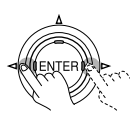
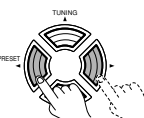
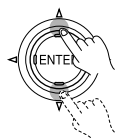
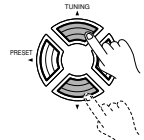

5. Use the ▲ and ▼ cursor buttons to select “Front L/R” and then use the ◀ and ▶ cursor buttons to select the front speaker setting.

Large: Select if the front speakers are large sized.

Small: Select if the front speakers are small sized.

- If “No” is selected for the Subwoofer setting, this setting is fixed to “Large.”

6. Use the ▲ and ▼ cursor buttons to select “Center” and then use the ◀ and ▶ cursor buttons to select the center speaker setting.

None: Select if no center speaker is connected.

Large: Select if the center speaker is large sized.

Small: Select if the center speaker is small sized.

- If “Small” is selected for the Front setting, “Large” cannot be selected for this setting.

7. Use the ▲ and ▼ cursor buttons to select “Surround L/R” and then use the ◀ and ▶ cursor buttons to select the surround speaker setting.

None: Select if no surround left and right speakers are connected.

Large: Select if the surround left and right speakers are large sized.

Small: Select if the surround left and right speakers are small sized.

- If “Small” is selected for the Front setting, “Large” cannot be selected for this setting.

8. Use the ▲ and ▼ cursor buttons to select “Surround back” and then use the ◀ and ▶ cursor buttons to select the surround back speaker setting.

None: Select if no surround back speaker is connected.

Large: Select if the surround back speaker is large sized.

Small: Select if the surround back speaker is small sized.

- If “None” is selected for the Surround setting, this setting will be disabled.
- If “Small” is selected for the Surround setting, “Large” cannot be selected for this setting.

9. Use the ▲ and ▼ cursor buttons to select “Crossover” and then use the ◀ and ▶ cursor buttons to select the crossover frequency mode setting.

Adjustable Crossover for Bass Management

TX-SR701/701E

f. Crossover

This setting allows you to set the crossover frequency for your speaker system. The crossover frequency is the minimum frequency delivered to a speaker and can be set to 40 Hz, 60 Hz, 80 Hz (THX), 100 Hz, 120 Hz, or 150Hz. Select “80Hz (THX)” if you are using a THX-certified speaker system. This setting is valid when “Subwoofer” is set to “Yes,” or for speakers that are set to “Small,” at the “Speaker Config” menu. Frequencies below this are cut from speakers set to “Small” and sent to the subwoofer (or to speakers set to “Large”).

Note:

When “Large” is set, the complete frequency range for that speaker channel will be output. When “Small” is set, the frequencies below 80 Hz for that speaker channel are output to the subwoofer. If Subwoofer is set to “No” in the Speaker Config menu, then they will be output to the left and right front speakers. (Set all speakers for THX speaker systems to “small.”)

TX-SR601/601E

f. Crossover

This setting allows you to set the crossover frequency for your speaker system. The crossover frequency is the minimum frequency delivered to a speaker and can be set to 60 Hz, 80 Hz, 100 Hz, 120 Hz, or 150Hz. This setting is valid when “Subwoofer” is set to “Yes,” or for speakers that are set to “Small,” at the “Speaker Config” menu. Frequencies below this are cut from speakers set to “Small” and sent to the subwoofer (or to speakers set to “Large”).

The following table lists the crossover frequency you should choose depending on the diameter of your front speakers.

Front speaker diameter	crossover frequency
Larger than 12" (30cm)	40
8"~12" (20-30 cm)	60
6-1/2"~8" (16-20 cm)	80
5-1/4"~6-1/2" (13-16cm)	100
3-1/2"~5-1/4" (9-13 cm)	120
Less than 3-1/2" (9 cm)	150

Note:

When “Large” is set, the complete frequency range for that speaker channel will be output. When “Small” is set, the frequencies below 80 Hz for that speaker channel are output to the subwoofer. If Subwoofer is set to “No” in the 1-1. Speaker Config Sub-menu, then they will be output to the left and right front speakers.

Press the RETURN button to return to the main menu.

Press the SETUP button on the front panel or on the remote controller to exit the Setup menu.

Configuring the speakers

Setting the speaker distance from your normal listening position

Each speaker can be set between 1 and 30 feet (0.3 and 9 meters) in 1-foot (0.3 meter) increments. Select the setting closest to the actual distance from the speaker to your normal listening position.

Note:

Speakers that you selected “No” or “None” for in the “Speaker Config” menu will be disabled.

TX-SR701/701E

Notes:

- For the front L/R, center and subwoofer speakers, the speaker distance values you can set will be between the current maximum value(s) among all speakers and the values 10 feet (3 meters) lower than the current maximum value(s). For example, if the current maximum value is 30 feet (9 meters), the speaker distance values you can set will be between 20 feet (6 meters) and 30 feet (9 meters).
- For the surround and surround back speakers, the speaker distance values you can set will be between the current maximum value(s) among all speakers and the values 20 feet (6 meters) lower than the current maximum value(s).
- Whenever you set the speaker distance value for any one of the speakers, if you enter any values higher than the current maximum value, the value you enter will be the new maximum value and any other speaker distance values you already set will automatically be adjusted to the values so that they keep the same value difference to the new maximum value as the one to the last maximum value.

1. Use the ▲ and ▼ cursor buttons to select “3. Speaker Distance” on the main menu and then press the ENTER button.

The “Speaker Distance” menu appears.

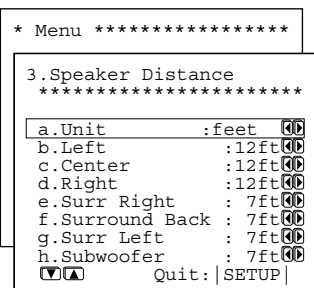
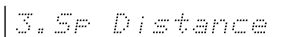
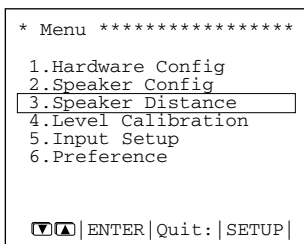
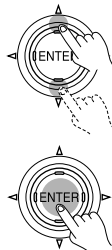

2. Use the ▲ and ▼ cursor buttons to select “Unit” and then use the ◀ and ▶ cursor buttons to select the desired unit of measure.

feet: Select if you will enter the distances in feet.

meters: Select if you will enter the distances in meters.

3. Use the ▲ and ▼ cursor buttons to select “Left” and then use the ◀ and ▶ cursor buttons to set the distance from the front left speaker to your normal listening position.

4. Use the ▲ and ▼ cursor buttons to select “Center” and then use the ◀ and ▶ cursor buttons to set the distance from the center speaker to your normal listening position.

5. Use the ▲ and ▼ cursor buttons to select “Right” and then use the ◀ and ▶ cursor buttons to set the distance from the front right speaker to your normal listening position.

6. Use the ▲ and ▼ cursor buttons to select “Surr Right” and then use the ◀ and ▶ cursor buttons to set the distance from the surround right speaker to your normal listening position.

7. Do the following when you use two surround back speakers. If you use one surround back speaker, go to step 8.

Use the ▲ and ▼ cursor buttons to select “Surround Back R” and then use the ◀ and ▶ cursor buttons to set the distance from the surround back right speaker to your normal listening position.

8. When you use one surround back speaker:

Use the ▲ and ▼ cursor buttons to select “Surround Back” and then use the ◀ and ▶ cursor buttons to set the distance from the surround back speaker to your normal listening position.

When you use two surround back speakers:

Use the ▲ and ▼ cursor buttons to select “Surround Back L” and then use the ◀ and ▶ cursor buttons to set the distance from the surround back left speaker to your normal listening position.

9. Use the ▲ and ▼ cursor buttons to select “Surr Left” and then use the ◀ and ▶ cursor buttons to set the distance from the surround left speaker to your normal listening position.

10. Use the ▲ and ▼ cursor buttons to select “Subwoofer” and then use the ◀ and ▶ cursor buttons to set the distance from the subwoofer speaker to your normal listening position.

Press the RETURN button to return to the main menu.

Press the SETUP button on the front panel or SETUP button on the remote controller button to exit the Setup menu.

Configuring the speakers

TX-SR601/601E

- Use the ▲ and ▼ cursor buttons to select “3. Speaker Distance” on the main menu and then press the ENTER button.

The “Speaker Distance” menu appears.

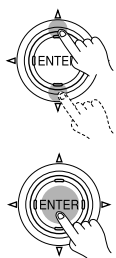

```
* Menu *****
1.Hardware Config
2.Speaker Config
3.Speaker Distance
4.Level Calibration
5.Input Setup
6.Preference

[ENTER] | Quit: | SETUP |
```

```
* Menu *****
3.Speaker Distance
*****
a.Unit : feet [ENTER]
b.Front L/R : 12ft [ENTER]
c.Center : 12ft [ENTER]
d.Surr Right : 7ft [ENTER]
e.Surround Back : 7ft [ENTER]
f.Surr Left : 7ft [ENTER]
g.Subwoofer : 7ft [ENTER]

[ENTER] | Quit: | SETUP |
```

```
3.Sp Distance
```

```
Unit : feet
```

- Use the ▲ and ▼ cursor buttons to select “Unit” and then use the ◀ and ▶ cursor buttons to select the desired unit of measure.

feet: Select if you will enter the distances in feet.

meters: Select if you will enter the distances in meters.

- Use the ▲ and ▼ cursor buttons to select “Front L/R” and then use the ◀ and ▶ cursor buttons to set the distance from the front speakers to your normal listening position.
- Use the ▲ and ▼ cursor buttons to select “Center” and then use the ◀ and ▶ cursor buttons to set the distance from the center speaker to your normal listening position.

Note:

The speaker distance value for center speaker cannot be 5 feet (1.5 meters) higher and 5 feet (1.5 meters) lower than the one set to front speaker. For example, if 20 feet (6 meters) is set for the front speakers, then the center speaker distance can only be set between 15 and 25 feet (4.5 and 7.5 meters).

- Use the ▲ and ▼ cursor buttons to select “Surr Right” and then use the ◀ and ▶ cursor buttons to set the distance from the surround right speaker to your normal listening position.
- Use the ▲ and ▼ cursor buttons to select “Surround Back” and then use the ◀ and ▶ cursor buttons to set the distance from the surround back speaker to your normal listening position.

Note:

The speaker distance value for surround back speaker cannot be 5 feet (1.5 meters) higher and 15 feet (4.5 meters) lower than the one set to front speaker. For example, if 20 feet (6 meters) is set for the front speakers, then the surround back speaker distance can only be set between 5 and 25 feet (1.5 and 7.5 meters).

- Use the ▲ and ▼ cursor buttons to select “Surr Left” and then use the ◀ and ▶ cursor buttons to set the distance from the surround left speaker to your normal listening position.

- Use the ▲ and ▼ cursor buttons to select “Subwoofer” and then use the ◀ and ▶ cursor buttons to set the distance from the subwoofer speaker to your normal listening position.

Note:

The speaker distance value for subwoofer speaker cannot be 5 feet (1.5 meters) higher and 5 feet (1.5 meters) lower than the one set to front speaker. For example, if 20 feet (6 meters) is set for the front speakers, then the subwoofer speaker distance can only be set between 15 and 25 feet (4.5 and 7.5 meters).

Press the RETURN button to return to the main menu.

Press the SETUP button on the front panel or SETUP button on the remote controller button to exit the Setup menu.

Calibrating the speaker levels

Use this menu to set the volume for each speaker so that each volume is heard by the listener at the same level. This is especially important for speaker layouts where the left and right speakers are at different distances or in asymmetrical positions due to room designs and configurations. These settings and the distance settings performed in the Speaker Distance menu are vital to create the proper sound space and dynamics.

Note:

The speaker level settings here are not effective for multi-channel input sources. To adjust the speaker levels for multi-channel input sources, you will need to use the CH SEL, LEVEL ▲, and LEVEL ▼ buttons on the remote controller. See page 44.

TX-SR701/701E

- Use the ▲ and ▼ cursor buttons to select “4. Level Calibration” on the main menu and then press the ENTER button.

The “Level Calibration” menu appears.

You will hear a pink noise from the front left speaker. At this time, the volume of the pink noise will automatically increase to a predetermined reference level (82).

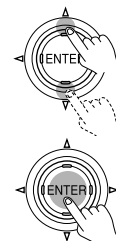

```
* Menu *****
1.Hardware Config
2.Speaker Config
3.Speaker Distance
4.Level Calibration
5.Input Setup
6.Preference

[ENTER] | Quit: | SETUP |
```

```
4.Level Cal
```

```
* Menu *****
4.Level Calibration
*****
a.Left : 0dB [ENTER]
b.Center : 0dB [ENTER]
c.Right : 0dB [ENTER]
d.Surr Right : 0dB [ENTER]
e.Surr Back : 0dB [ENTER]
f.Surr Left : 0dB [ENTER]
g.Subwoofer : 0dB [ENTER]

[ENTER] | Quit: | SETUP |
```

```
Left : 0
```

Note:

Speakers that you selected “No” or “None” for in the “Speaker Config” menu will be disabled.

Configuring the speakers

2. Use the ▲ and ▼ cursor buttons to select “Left.”

- (1) Remember the volume level of this noise and then press the ▼ cursor button. (Note that this can be adjusted to any level between -12 and +12 decibels in 1-decibel increments. For subwoofer, values between -15 and +12 dB can be set.) The TX-SR701/701E will now emit the pink noise from the center speaker.
- (2) Using the ◀ and ▶ cursor buttons, adjust the volume level of the noise from the center speaker so that it is at the same level as that was emitted from the front left speaker. You can jog back and forth between the speakers to help you compare the volume levels.
- (3) Press the ▼ cursor button again. The TX-SR701/701E will now emit the pink noise from the front right speaker.
- (4) Repeat steps (2) and (3) above for the front right and other speakers until all speakers are adjusted to the same volume level.

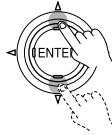

Notes:

- Speakers that you selected “No” or “None” for in the “Speaker Config” menu will be disabled.
- To accurately set the output levels, it is recommended to use a handheld sound pressure level (SPL) meter. Set the meter to C-weighting and slow averaging. A Radio Shack® SPL meter or equivalent is recommended. Using the internal channel noise generators, set each channel so that you read a 75 decibel sound pressure level.

Using the remote controller

1. Press the TEST button.

You will hear a pink noise which will be emitted from the front left speaker. At this time, the volume of the pink noise will automatically increase to a predetermined reference level (82).



- (1) Remember the volume level of this noise and then press the CH SEL button. The TX-SR701/701E will now emit the pink noise from the center speaker.
- (2) Using the LEVEL ▲ /▼ buttons, adjust the volume level of the noise from the center speaker so that it is at the same level as that was emitted from the front left speaker.
- (3) Press the CH SEL button again. The TX-SR701/701E will now emit the pink noise from the front right speaker.
Use the LEVEL ▲ /▼ buttons to adjust the volume of the noise from the front right speaker so that it is the same level as that was emitted from the center speaker.
- (4) Use the CH SEL button to select other speakers and adjust the volumes until all speakers are adjusted to the same level.
The pink noise level can be adjusted to anywhere between -12 and +12 decibels for all speakers in 1-decibel increments. For subwoofer, values between -15 and +12 dB can be set.

2. Press the TEST button to complete the procedure.



TX-SR601/601E

1. Use the ▲ and ▼ cursor buttons to select “4. Level Calibration” on the main menu and then press the ENTER button.

The “Level Calibration” menu appears.

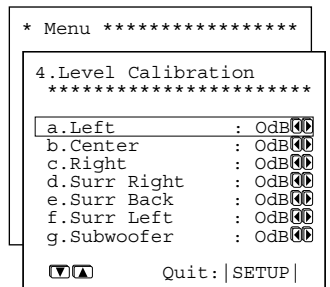
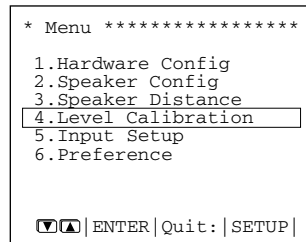
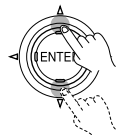

4. Level Cal

Left : 0

Note:

Speakers that you selected “No” or “None” for in the “Speaker Config” menu will be disabled.

2. Use the ▲ and ▼ cursor buttons to select “Left.”

You will hear a pink noise from the front left speaker.

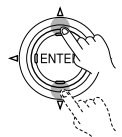

- (1) Remember the volume level of this noise and then press the ▼ cursor button. The TX-SR601/601E will now emit the pink noise from the center speaker.
- (2) Using the ◀ and ▶ cursor buttons, adjust the volume level of the noise from the center speaker so that it is at the same level as that was emitted from the front left speaker.
- (3) Press the ▼ cursor button again. The TX-SR601/601E will now emit the pink noise from the front right speaker.
Use the ◀ and ▶ cursor buttons to adjust the volume of the noise from the front right speaker so that it is the same level as that was emitted from the center speaker.
- (4) Use the ▼ cursor button to select other speakers and adjust the volumes until all speakers are adjusted to the same level.

The pink noise level can be adjusted to anywhere between -12 and +12 decibels for all speakers in 1-decibel increments. For subwoofer, values between -15 and +12 dB can be set.

Press the RETURN button to return to the main menu. Press the SETUP button on the front panel or on the remote controller button to exit the Setup menu.

Configuring the speakers

Using the remote controller

1. Press the TEST button.

You will hear a pink noise which will be emitted from the front left speaker.



- (1) Remember the volume level of this noise and then press the CH SEL button. The TX-SR601/601E will now emit the pink noise from the center speaker.
- (2) Using the LEVEL ▲/▼ buttons, adjust the volume level of the noise from the center speaker so that it is at the same level as that was emitted from the front left speaker.
- (3) Press the CH SEL button again. The TX-SR601/601E will now emit the pink noise from the front right speaker. Use the LEVEL ▲/▼ buttons to adjust the volume of the noise from the front right speaker so that it is the same level as that was emitted from the center speaker.
- (4) Use the CH SEL button to select other speakers and adjust the volumes until all speakers are adjusted to the same level. The pink noise level can be adjusted to anywhere between -12 and +12 decibels for all speakers in 1-decibel increments. For subwoofer, values between -15 and +12 dB can be set.













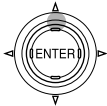

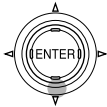
2. Press the TEST button to complete the procedure.

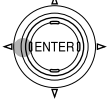

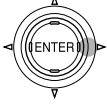
Buttons used for navigating through the menus

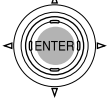
You can change settings in the Setup Menu using the buttons on the front panel and on the remote controller.

The buttons on the remote controller correspond to those on the TX-SR701/701E/601/601E as shown below.

Buttons on remote controller	Buttons on TX-SR701/701E/601/601E
Displaying the Main Menu and exiting the menu	
 SETUP	 SETUP
Selecting a menu or menu item	
 (upper edge of ENTER button)	 UP
 (lower edge of ENTER button)	 DOWN
Setting the value	
 (left edge of ENTER button)	 LEFT
 (right edge of ENTER button)	 RIGHT
Selecting the menu	
 ENTER	 ENTER
Returning to the previous screen	
 RETURN	 RETURN

Listening to Radio Broadcasts

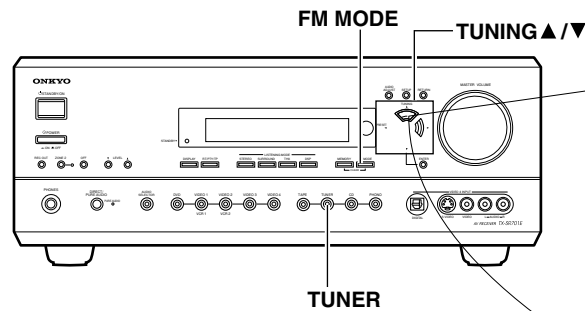

One of the features of the TX-SR701/701E/601/601E that is most frequently used is its ability to play FM and AM broadcast radio stations. The TX-SR701/701E/601/601E provides a number of listening modes perfect for listening to the radio and getting the most out of your audio system. Also, by presetting radio stations that you listen to frequently, you can select them easily by pressing the CH \updownarrow button on the remote controller.

Listening to a stereo radio station (FM mode)

When you tune into a radio station, ► TUNED ◀ indicator appears in the display. If you tune into an FM station in stereo, then “FM STEREO” appears. If the signal is weak, it may be impossible to tune into the station in stereo. In such a case, **press the FM MODE button** on the front panel. The AUTO indication disappears and the radio station is output in the monaural mode. To return to stereo, press the FM MODE button again. “AUTO” appears. Some inter-station noise may be heard, but the sound will not cut in and out as it would if stereo was selected.



Tuning into a radio station

1. Press the TUNER input source button.

Each time you press the TUNER button, the input source changes between AM and FM.



2. Using the TUNING ▲ and ▼ buttons on the front panel, tune into the station you desire.

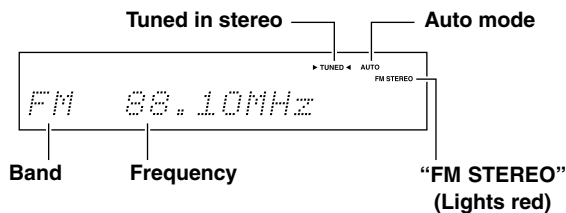
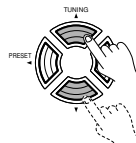

- The tuner frequency changes in 100-kHz (or 50-kHz) increments for FM and 10-kHz (or 9-kHz) increments for AM.
- You can press the TUNING ▲ or ▼ button continuously for more than 0.5 seconds to scan for an FM station in the direction of the button you pressed (FM auto tuning mode). After you release the button and a station is received in stereo, the scanning stops.
- The European model allows you to receive RDS broadcasts. See page 39 for more information regarding tuning into RDS broadcasts.

Listening to Radio Broadcasts

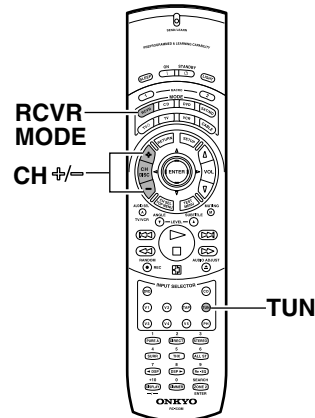
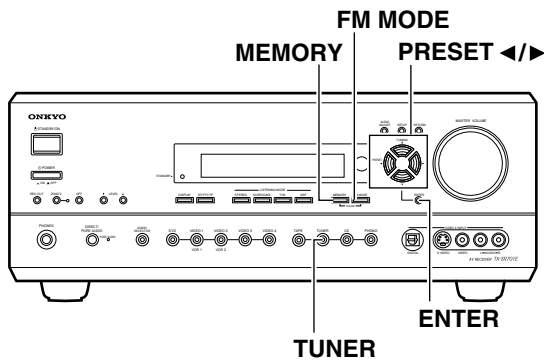

Presetting a radio station

1. Tune into the radio station you desire (see "Tuning into a radio station").

FM 88.10MHz

2. Press the MEMORY button on the front panel.

The MEMORY indicator lights red.



"MEMORY" (Lights red) Flashes

FM 88.10MHz 7^{ch}

3. Using the PRESET \leftarrow/\rightarrow buttons, select a preset number (from 1 to 40) to assign the station.

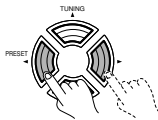

4. Press the ENTER button to finalize the procedure.

The memory indicator turns off and the assigned number lights.



Lights

FM 88.10MHz 7^{ch}

This programs the radio station as a preset radio station.

- Up to 40 stations can be stored in memory as preset radio stations.

Selecting a preset radio station

1. Press the TUNER input source button.



2. Press the PRESET \leftarrow/\rightarrow buttons and select the number of the desired preset station.

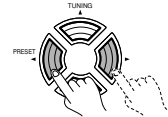

When using the remote controller:

1. Press the RCVR MODE button. The RCVR MODE button lights.

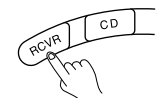

2. Press the TUN button.



3. Press the CH \pm/\mp button and select the number of the desired preset station.

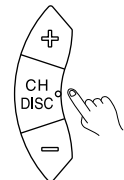

Erasing a preset radio station

This can only be performed at the TX-SR701/701E/601/601E.

1. Press the TUNER button and press the PRESET \leftarrow/\rightarrow buttons to select the preset radio station that you want to erase (see above).

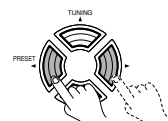

FM 88.10MHz 7^{ch}

2. Press and hold the MEMORY button and then press the FM MODE button.

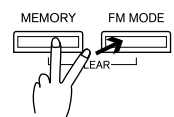

The selected preset station is erased.

Listening to RDS broadcasts (European models only)

Listening to RDS broadcasts

RDS reception is available only on the European model and only in areas where RDS broadcasts are available.

What is RDS?

RDS stands for Radio Data System and is a type of FM broadcasting. RDS was developed within the European Broadcasting Union (EBU) and is available in most European countries. Many FM broadcasting stations now transmit the RDS signals, which provide the additional information required. RDS provides you with various services so that you can choose a station that broadcasts your favorite categories of music, news, or other information.

There are three main classifications of RDS broadcasts. Though they can be tuned into by using the TUNING buttons as normal stations, RDS broadcasts allow you to scan for stations of the type and classification for which you are looking. This makes it much easier for you to find the station you want (see “Performing a PTY scan” and “Performing a TP scan” on page 40). The three main classifications are explained below.

RT: Radio Text

When an RDS station broadcasting RT information is selected, the text information received from the station is displayed.

PTY: Program Type

When an RDS station broadcasting PTY information is selected, the station type (classification) is displayed.

TP: Traffic Program

When an RDS station broadcasting TP information is selected, traffic information will be broadcasted periodically.

Notes:

- In some cases, the characters displayed on the display of the TX-SR701E/601E may not be exactly the same as the ones broadcast by the radio station. Also, unusual characters may appear on the display if the TX-SR701E/601E receives characters that cannot be displayed correctly. This is not a malfunction.
- When an RDS station broadcasting PS information is selected, the name of the station is displayed instead of the frequency.

PTY program types in Europe

The text given below in parenthesis is what is actually displayed on the TX-SR701E/601E.

None (NONE):

No program type.

News reports (NEWS):

Reports on current events and happenings.

Current affairs (AFFAIRS):

Topical reporting of current affairs, often with a wider range of topics than news reports.

Information (INFO):

General information such as weather forecasts, consumer affairs, medical help, etc.

Sport (SPORT):

Live sports action, sports news, and interviews.

Education (EDUCATE):

Formal educational programs.

Drama (DRAMA):

Radio plays and serials.

Culture (CULTURE):

Cultural programs (including religious affairs).

Science and technology (SCIENCE):

Programs about the natural sciences and technology.

Varied (VARIED):

Speech-based programs not covered by the above categories (e.g., quizzes, panel games, and comedy).

Pop music (POP M):

Popular commercial music, usually from past or present sales charts (e.g., Top 40).

Rock music (ROCK M):

Popular music with an alternative appeal, often not appearing on sales charts.

Middle of the road music (M.O.R.M):

Easy listening music (as opposed to Pop, Rock, or Classical).

Light classics (LIGHT M):

Classical music for general rather than specialist appreciation.

Serious classics (CLASSICS):

Performances of major orchestral works, symphonies, chamber music, etc. (including the Grand Opera).

Other music (OTHER M):

Music styles not covered by the above categories (e.g., Jazz, Rhythm & Blues, Folk, Country, and Reggae).

• Alarm (ALARM):

When an RDS station is making an emergency broadcast, ALARM will flash on the display.

Listening to RDS broadcasts (European models only)

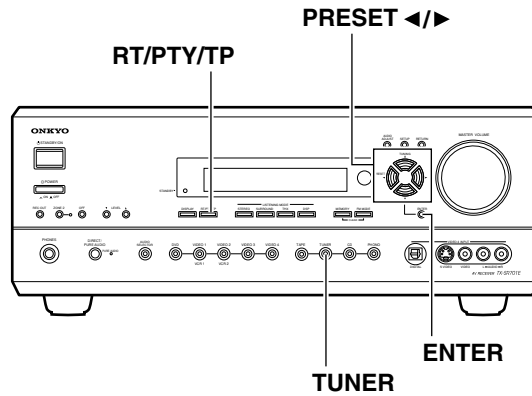

Displaying Radio Text (RT)

If the station you are currently tuned into is broadcasting RT signals, they will be displayed in the front display of the TX-SR701E/601E. If the station does not, this function will be ignored.

1. To display the radio text, press the RT/PTY/TP button once.



- If the station you are currently listening to is not an RDS station, only the frequency of the station will appear.
- If "Waiting" appears on the display, more time is required to receive the RT information. When the information is received, the characters will scroll across the front display.
- If "No Text Data" appears on the display, RT information is not available.
- The display shows the frequency for 3 seconds and returns to program service name.

Performing a PTY scan

1. Press the TUNER input source button and select the FM input source.



2. Press the RT/PTY/TP button twice.

The current program type appears on the display.



ROCK M

3. Using the ◀▶ buttons, select the PTY program type you desire.

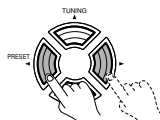

LIGHT M

4. Press the ENTER button.

The TX-SR701E/601E will scan until it reaches a station of the program type you selected. It will then stop briefly at that station before continuing on until it reaches the next station. Pressing the ENTER button stops the PTY scan at that point. If you press the RT/PTY/TP while "NONE" is displayed, "PTY ?" will appear. In this case, return to step 3.



5. Press the ENTER button when it reaches the station to which you want to listen.

"Not Found" will appear when no RDS signal is being received from the station.



Performing a TP scan

1. Press the TUNER input source button and select the FM input source.



2. Press the RT/PTY/TP button three times.



[TP]

"[TP]" will appear if the current station is broadcasting TP signals. This station will periodically broadcast traffic information. To find a different station, proceed to the next step. Also, if "TP" is displayed, proceed to the next step.

3. Press the ENTER button.

The TX-SR701E/601E will scan until it reaches a station broadcasting traffic information. If "Not Found" appears on the display, a TP station cannot be located.



Selecting an Audio Component

TX-SR701/701E

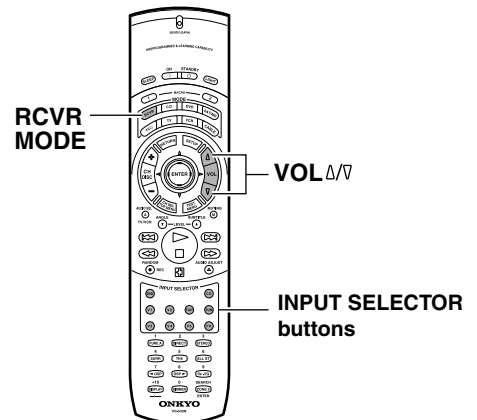
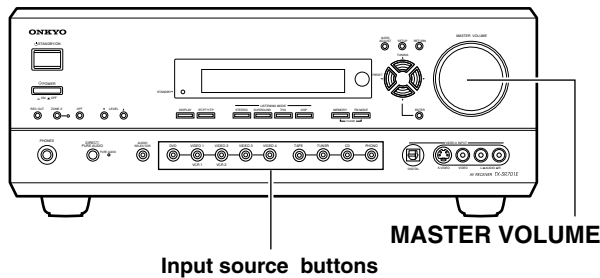

Basic operation

If you want to perform these operations using the remote controller, first press the RCVR MODE button.

1. Press the desired input source.

TX-SR701/701E

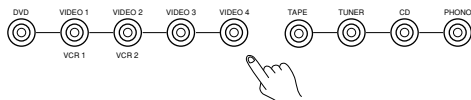

TX-SR601/601E

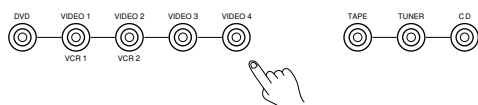

Remote controller

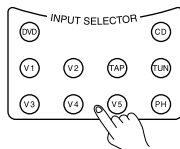

The selected source name appears on the display. See “Enjoying DVD multichannel audio playback” (see page 44) when a DVD player with a 5.1-channel input port is connected to the TX-SR701/701E/601/601E.

2. Start playing the selected input source.

Follow the operating instructions for the source device.

3. Adjust the volume to an appropriate level.

TX-SR701/701E/601/601E

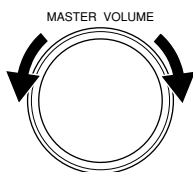

Remote controller

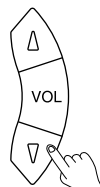

Adjusting the main volume adjusts the volume level of all the speakers connected to the TX-SR701/701E/601/601E together. If headphones are connected, this also adjusts the volume heard from the headphone speakers. To adjust the volume, either press the VOL Δ/V buttons on the remote controller or turn the MASTER VOLUME dial. To increase the volume, turn the dial clockwise; to decrease the volume, turn the dial counterclockwise. The volume can be set to Min, 1 to 99, and Max.

- For information about selecting the listening mode, see pages 46-51.
- You can set the sound quality using the Audio Adjust menu. (See page 57 for more information.)
If no audio output is heard from the digital source (DVD, CD, etc.) you have selected, see “Digital Input” on page 52.

Selecting an Audio Component

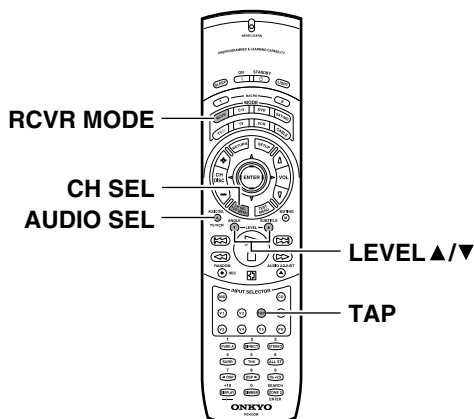
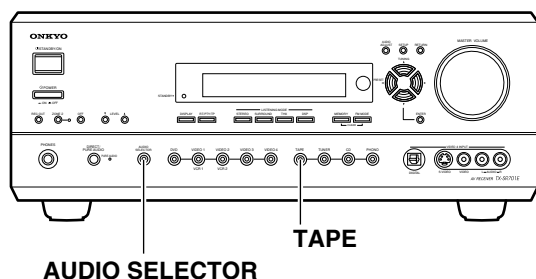

Selecting the type of audio input signal

Press the AUDIO SELECTOR button on the front panel (or AUDIO SEL button on the remote controller) to change the audio mode. Each time the button is pressed, the mode changes from “Auto” → “Multich” (only if DVD is selected as the input source) → “Analog” and back to “Auto.”

TX-SR701/701E/601/601E



Remote controller



Auto (automatic detection): With this setting, the TX-SR701/701E/601/601E automatically detects whether the input signal is digital or analog. When a digital signal is not input, then the analog signal is played. This setting only appears if a digital input is selected for the Digital Input setting at “Input Setup” → “Digital Input” (see page 52).

Multich (Multichannel): Select this setting to play back the multi-channel input from a DVD player with a 5.1-channel input port.

Analog: Select this setting to play back the input from a source component connected to analog audio input jacks. With this setting, even if a digital signal is input from the same component, only the analog signal will be output.

Selecting the setting mode with the Cursor ◀ / ▶ button while “Auto” appears

Auto: The digital signal suitable for the input signal will be preceded for playback. When there is no digital signal input, analog signal will be played.

DTS: Select this if you play DTS-formatted CD in “Auto” mode and hear noise during fast-forward or rewind operation. Non-DTS sound input will not be output.

PCM: Select this if you hear sound gap between PCM tracks such as ones on CD in “Auto” mode. Non-PCM sound input will not be output.

Notes:

- When you play DTS-formatted CD or LD, be sure to select “Auto” or “DTS.” If you select “PCM,” noise will be heard.
- If a DTS signal is not input when “DTS” is selected, the TX-SR701/701E/601/601E will not automatically switch to analog output even though “Auto” is selected with the AUDIO SELECTOR button.

Notes on DTS:

- If you play a DTS-formatted CD or LD when the “PCM” setting is selected on the TX-SR701/701E/601/601E, the DTS encoded signal will not be decoded and noise will be output. This noise could damage the amplifier and speakers. Therefore, be sure to select “Auto” or “DTS” and use the digital input jacks (OPT or COAX) to connect the DTS source.
- If you play a DTS-formatted CD or LD when “Auto” is selected, you may hear a noise for a short while until the DTS decoder recognizes the DTS-encoded signal and starts operating. This is not a malfunction.
- If you press the pause or skip button on the player while playing a DTS source, a short noise may be heard. This is not a malfunction. In such cases, try playing the source in the “DTS” selected.
- The DTS indicator on the TX-SR701/701E/601/601E lights while a DTS source is played. When playback finishes and the DTS signal transmission stops, the TX-SR701/701E/601/601E remains in DTS mode and the DTS indicator remains lit. This prevents noise when you operate the pause or skip button on the player. Therefore, if the source is immediately switched from DTS to PCM, the PCM signal may not be played. In this case, stop the playback of the source on the player for about three seconds and then resume playback.
- You may not be able to play some DTS source signals from certain CD players and LD players even when you connect the player to the TX-SR701/701E/601/601E digitally. This is because the digital signal has been processed (such as the output level, sampling frequency, or frequency response) and the TX-SR701/701E/601/601E cannot recognize the signal as DTS data. Therefore you may hear noise when you play a DTS source while processing the signal.
- The outputs for the VIDEO 1 OUT, VIDEO 2 OUT, and TAPE OUT output analog audio signals. Do not record from CDs or LDs that support DTS using these outputs. If you do, the DTS-encoded signal will be recorded as noise.
- If a CD or LD encoded in the DTS format is played back with “PCM” selected, only noise will be produced. Always select “Auto” or “DTS” when playing back DTS-encoded sources.

Selecting an Audio Component

Temporarily changing the speaker output levels

To change the individual speaker volumes temporarily, follow the procedure given below. Each channel can be set between -12 and +12 decibels. For subwoofer, values between -15 and +12 decibels can be set. Note that the calibration settings will return to the original settings when the TX-SR701/701E/601/601E is put in standby.

Using the remote controller:

1. Press the RCVR MODE button.

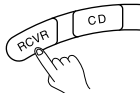

2. Press the CH SEL button and select the desired speaker.



3. Press the LEVEL ▲ or ▼ button to adjust the volume level.



Notes:

- You cannot select a speaker if the configuration value of the speaker is set to “No” or “None.”
- If the speaker level is set to +1 dB or higher, the maximum level indicated on the display will change if you raise the volume level.
- When you press the TEST button after you set the level, the current level will be used as the value set via the test tone.

To change the display of the input source from TAPE to MD

If you connected an MD recorder to the TAPE jacks of the TX-SR701/701E/601/601E, you can have “MD” appear when the TAPE source button is pressed. By changing the display, when an Onkyo MD recorder is **RI**-connected, the **RI** system functions will become enabled.

Changing the display:

Press and hold down the TAPE source button until the display changes from TAPE to MD (approx. 3 seconds).

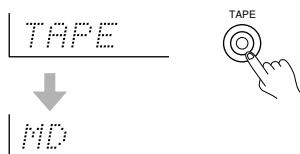

To return the display to its original setting, perform the same procedure. This setting is necessary to allow **RI** system functions for a connected Onkyo cassette tape or MD recorder.

Selecting an Audio Component

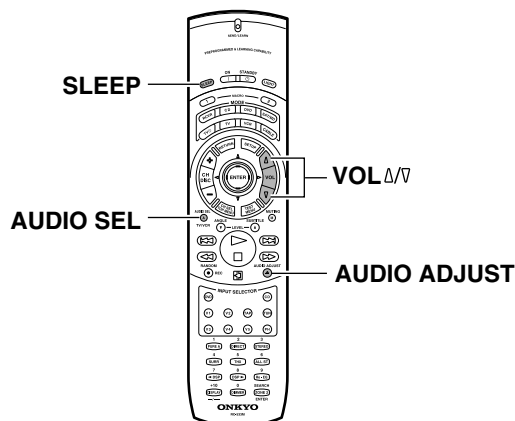
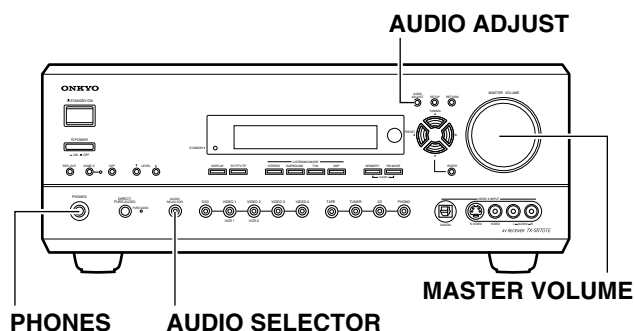

Using the sleep time (remote controller only)

The SLEEP button enables you to set the TX-SR701/701E/601/601E to turn off automatically after a specified time period. If you press it once, the TX-SR701/701E/601/601E will turn off after 90 minutes. Each time it is pressed thereafter, this remaining time until the TX-SR701/701E/601/601E turns off decreases by 10 minutes (i.e., from 90 to 80 minutes). While the sleep function is enabled, you can press the SLEEP button to see how much time is left. If the SLEEP button is pressed when the time displayed is less than 10 minutes, the sleep function is cancelled.

Remote controller

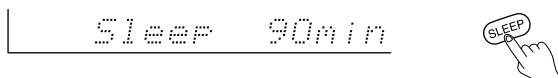

If you are using the remote zone (Zone 2), it will turn off at the same time as the main zone. If you want to set the sleep function for Zone 2 only, set the sleep function with the main zone turned on and then put the main zone into the standby state.

Listening with headphones

To listen with headphones, plug a pair of headphones with a standard stereo plug into the PHONES jack on the TX-SR701/701E/601/601E front panel.

When you connect the headphones, the TX-SR701/701E/601/601E will enter the STEREO mode automatically and no sound will be heard from the speakers. When the headphones are unplugged, the TX-SR701/701E/601/601E returns to its original listening mode. When using the headphones, you can only use the Direct, Stereo, and Pure Audio (TX-SR701/701E only) listening modes. If you have selected multichannel audio, you will only hear the sound output to the front right and left channels.

The headphone volume level can be adjusted at the Setup Menu (see page 56).

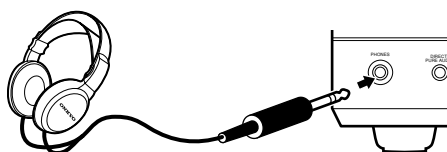

Note:

The signal to the remote zone (Zone 2) will not be affected by whether or not headphones are connected.

Enjoying DVD multichannel audio playback

1. Press the DVD input source button.
2. Select "Multich" using the AUDIO SELECTOR button on the front panel (or AUDIO SEL button on the remote controller).

TX-SR701/701E/601/601E



Remote controller



3. Turn on the connected DVD player and start playing the desired media.

4. If necessary, adjust the output level of each speaker as desired (see page 43).

Adjust the volume at each speaker so that all the volumes sound at the same level at the listening position. For the front right, front left, center, surround right, and surround left speakers, the output levels can be adjusted between -12 and +12 decibels. The subwoofer can be adjusted between -30 and +12 decibels.

5. Adjust the volume with the MASTER VOLUME dial or the VOL Δ/V buttons on the remote controller.

Selecting an Audio Component

Using the tone control:

To make bass and treble adjustment work for multichannel sources, you must first set the tone control to “On.”

To turn on the tone control:

1. Press the **SURROUND** button (or **SURR** button on the remote controller).

TX-SR701/701E/601/601E



Remote controller



“Tone On” appears on the display and the tone control is turned on.

2. Press the **AUDIO ADJUST** button and then the **▲** and **▼** cursor buttons to select Bass (or Treble).

TX-SR701/701E/601/601E

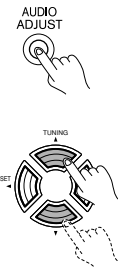

Remote controller



3. Press the **◀** and **▶** cursor buttons to set the desired level.

TX-SR701/701E/601/601E

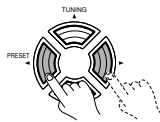

Remote controller

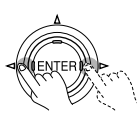

To turn off the tone control:

Press the **DIRECT** button.

TX-SR701/701E



TX-SR601/601E

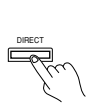

Remote controller

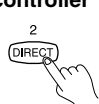

“Direct” appears on the display and the tone control is turned off.

Notes:

- (TX-SR701/701E only) When you turn on the tone control, the settings in “Speaker Config” and “Speaker Distance” will be used for multichannel playback.
- (TX-SR701/701E only) When you play back multichannel sources, you can select the Pure Audio mode by pressing the PURE AUDIO button. To exit the Pure Audio mode, press the DIRECT or SURROUND button.
- If you change the speaker levels in step 4 above, these new levels for multichannel sources will have no effect on the settings at “Level Calibration.”

Switching the display

While listening to or watching an input source, you can display the information regarding the type of source and signal being input by pressing the **DISPLAY** button on the TX-SR701/701E/601/601E or the remote controller.

You can set separate video displays for when the input source is set to AM or FM broadcasts and for when it is set to anything else.

TX-SR701/701E/601601/601E



Remote controller



When an input source other than FM or AM is selected:

Input + volume

DVD

Program format or sampling frequency*

Dolby D 3/2.1

Input + Listening mode or Multich

DVD Dolby D

* When the input signal is digital audio

The program format is displayed. For example, the display “Dolby D: 3/2.1” shows that the format is Dolby Digital with 5.1 discrete channels consisting of three front channels (front left, front right, and center), two surround channels (surround left and surround right), and the low frequency effect (LFE) channel.

When the front channel number is 2, they are the front left and front right; when it is 1, it is monaural. When the surround channel number is 1, it is monaural; when it is 0, there is no surround channel. When the LFE number is 0, there is no LFE channel. Also, if there is no program format for the input signal, nothing will be displayed.

When the input signal is linear PCM

The sampling frequency is displayed. For example, the display “PCM fs: 44.1k” shows that the signal is PCM and that the sampling frequency is 44.1 kHz.

When FM or AM is selected as the input source:

FM/AM frequency + Preset no.

FM 88.10MHz 1

FM/AM + Listening mode

FM Stereo

Temporarily turning off the sound

To turn off the sound momentarily, press the **MUTING** button on the remote controller. The **MUTING** indicator will flash and the sound from the speakers or headphones will be switched off by the receiver’s audio muting circuit. Press the **MUTING** button again to turn the sound back on.

Remote controller



Flashes

MUTING
Muting

Listening Modes

The TX-SR701/701E/601/601E's surround sound enables you to enjoy the presence of a movie theater or concert hall in your room. The configuration of the speakers is very important for the surround sound. Refer to "Connecting speakers" on page 25.

Before using a listening mode, make sure the Speaker Config, Speaker Distance, and Level Calibration parameters have been set (see pages 31 to 36). Once the parameters have been set, it is not necessary to set them again. See pages 48, 50 for information regarding how to select the listening mode.

Listening Modes

Mono

This mode is for playing old movies where the sound is recorded in monaural or for playing the left and right channels of movies separately that contain different language signals. This mode also allows you to listen to the multiplexed soundtracks on DVDs, and other media that have them.

Direct

This mode delivers pure sound with minimum sound quality adjustment and filtration. The sound recorded for the right and left front channels is output to the right and left front speakers only and not output to the subwoofer.

Pure Audio (TX-SR701/701E only)

Same as the direct mode except that the pure audio mode also turns off the display window, turns off the power supply to the video circuitry, and minimizes the sources of noise. The result is high-fidelity music playback true to the original source.

Stereo

All input sound is output from the left and right front speakers. The subwoofer is also used for playback.

T-D (Theater-Dimensional)

For the best enjoyment of your home theater, it is recommended that you have front left and right speakers, a center speaker, and surround left and right speakers. However, if you only have front left and right speakers, you can enjoy multichannel audio by using this mode.

This mode controls the characteristics of the sound that reaches each ear to reproduce a multi-speaker setup. To receive the full effect, there is an optimum listening position (sweet spot). Refer to the explanation of the listening angle. In addition, if the reflective sound components are large, it may be difficult to achieve the desired result, so be sure to set up your system and listening position to minimize reflective sound.

Dolby Pro Logic II

Opposed to Dolby Pro Logic, which had four channels (front, left, center, and surround) recorded into two channels with matrix processing and then played back in four channels, Dolby Pro Logic II uses a feedback logic circuit to have 5.1-channel surround audio (Dolby Surround, etc.) matrix-encoded into two channels and then played back in its original 5.1-channel form.

Dolby Pro Logic II provides a Movie mode designed for playing movies and a Music mode designed for listening to music. In the Movie mode, the surround channels, which used to provide monaural output over only a narrow frequency range, now provide complete stereo output over the full frequency range. The result is movie viewing with a realistic feel of movement. The Music mode uses the surround channels to provide a natural soundfield that cannot be provided with normal stereo output.

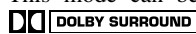
This mode can be used with VHS and DVD videos with the  mark and certain television programs. The Music mode can be used with music compact discs and other stereo sources.

Dolby D (Dolby Digital)

This mode is used for playing Dolby Digital sources. Dolby Digital is compressed digital data with a maximum of 5.1-channel surround sound. This source signal comes from DVDs and LDs that have the  mark and therefore recorded for 5.1-channel output.

- **Dolby Digital EX**

Enabled when playing back sources with surround tracks that were encoded using the Surround EX technology.

- **Dialog norm**

Dialogue Normalization (Dialog Norm) is a feature of Dolby Digital. When playing back software that has been encoded in Dolby Digital, sometimes you may see a brief message in the front panel display that reads Dialog Norm xdB ("x" being a numeric value). Dialogue Normalization serves to let you know if the source material has been recorded at a higher or lower level than usual. This data is automatically used by the Dolby Digital decoder to adjust the output volume of the source material without affecting the volume of your amplifier. Therefore, even if source material volume changes, you will not have to adjust the volume on your amplifier.

DTS Neo:6

This mode is for 6.1-channel playback of sources such as PCM or analog sources that have only two channels. The outputs of all six channels are a wide frequency range with a great separation between the different channels.

This mode can be set to the Cinema mode designed for playing movies and the Music mode designed for listening to music.

The Cinema mode is good for movies. The reproduced surround sound provide the same realistic feel of movement as 6.1-channel sources. This mode can be used with VHS and television programs with stereo sound.

The Music mode uses the surround channels to provide a natural sound space that cannot be provided with normal stereo output. This mode can be used with music CDs and other stereo sources.

DTS

This mode is used for playing DTS source.

DTS (Digital Theater System) is compressed digital data with a maximum 5.1-channel surround output (6.1-channel with DTS-ES Discrete sources) that allows for an extremely high-quality sound. This source signal requires a DVD player that supports DTS output and comes from DVDs, compact discs, and LDs that have the  mark.

DTS-ES Discrete 6.1

With the addition of the surround back channel, this new format has all 6.1 channels recorded independently for a completely discrete digital format. Since all channels are recorded independently, high-fidelity surround playback with the increased feeling of a separated sound space is achieved.

DTS-ES Matrix 6.1

This format has the surround back channel matrix encoded and inserted into the left and right surround channels so that at playback the output for the left, right, and back surround channels are decoded using a high-precision matrix decoder.

DTS 96/24

Automatically changes to this mode when playing back sources with surround tracks that were encoded using the DTS 96/24 technology.

THX (TX-SR701/701E only)

This mode is for playing back sources recorded in the THX format. For the utmost in fidelity when playing back THX sources, it is also recommended to use a THX-certified speaker system.

Listening Modes

- **THX Cinema**

This is the conventional 5.1-channel THX format. This mode should be used only when playing back sources that were mixed for playback in large movie theater environments.

- **THX Surround EX**

“THX Surround EX - Dolby Digital Surround EX” is a joint development of Dolby Laboratories and the THX division of THX Ltd.

In a movie theater, film soundtracks that have been encoded with Dolby Digital Surround EX technology are able to reproduce an extra channel which has been added during the mixing of the program. This channel, called Surround Back, places sounds behind the listener in addition to the currently available front left, front center, front right, surround right, surround left, and subwoofer channels.

This additional channel provides the opportunity for more detailed imaging behind the listener and brings more depth, spacious ambience, and sound localization than ever before.

When released to the home consumer market, movies that were created using the Dolby Digital Surround EX technology, may have a note to that effect on the packaging. A list of movies created using this technology can be found on the Dolby web site at <http://www.dolby.com>.

The TX-SR701/701E can play the 5.1-channel sources in THX surround EX mode, even if the source is not encoded in Dolby Digital Surround EX format. In this case, the sound actually output from the surround back channels depends on the source and may not fit your tastes.

All Ch Stereo

This mode is designed for playing background music. The front, surround, and surround back channels create a stereo image that encompasses the entire area.

Mono Movie

This mode is suitable for playing back monaural recording such as old movie soundtracks. The center channel delivers the unprocessed original sound, whereas the other channels deliver the center-channel sound processed with the appropriate reverberation. This allows you to enjoy monaural sound with the atmosphere of a movie theater.

Enhance

With multi channel speakers, you will get more active surround effect. When using the surround back speaker, the sound effect moves naturally through the surround back speaker position. This mode is good for music and TV sports programs.

Orchestra

This mode is appropriate for classical and opera music. The center channel is cut and the surround channels are emphasized to widen the stereo image. It will simulate the natural reverberation that is created in large halls.

Unplugged

This mode is suitable for acoustical instrumental sounds, vocals, and jazz music. By emphasizing the front stereo image, it will simulate the acoustics that you would experience in front of the stage.

Studio-Mix

This mode is for rock and popular music. The lively sounds are enhanced for a powerful acoustic image that simulates the feeling of being in a club or rock concert.

TV Logic

This mode gives realistic acoustics to TV programs that are aired from TV studios. It enhances the entire surround sound and clarity of the conversation.

Listening Modes

TX-SR701/701E

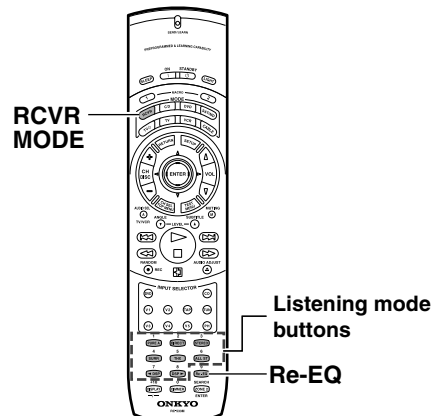
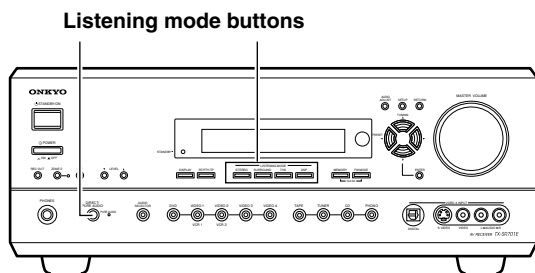

Selecting a listening mode (TX-SR701/701E)

- Refer to pages 46, 47 for more details of listening modes.
- Refer to page 54 for sources and listening modes.
- When playing Dolby Digital or DTS software, the listening mode will automatically change to Dolby Digital or DTS.

Tip:

You can set in advance a different listening mode for each input source. For more details, see page 54.

When using the remote controller, first press the RCVR MODE button before preceding to the step below.

Press one of the listening mode buttons to select the listening mode.

TX-SR701/701E

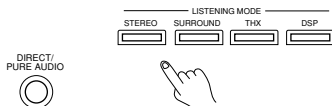

Remote controller

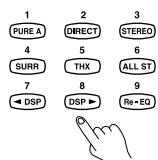

DIRECT/PURE AUDIO (DIRECT, PURE A): Changes the listening mode for the signal type that is currently being input from the selected input source to the Direct listening mode. If pressed, the corresponding settings in the “Input Setup” menu for the selected input source is also changed. When the listening mode is set to Direct, you can switch between Direct and Pure Audio. When you select Pure Audio, the video signal is interrupted (resulting in a blacked-out screen), and the PURE AUDIO indicator lights up.

Note:

In the Pure Audio mode, if any component video signal is presented on the COMPONENT VIDEO INPUT2 jack, it will be output to the COMPONENT OUTPUT jack.

STEREO: Changes the listening mode for the signal type that is currently being input from the selected input source to the Stereo listening mode. If pressed, the corresponding settings in the “Input Setup” menu for the selected input source is also changed (see page 54).

SURROUND (SURR): Changes the listening mode for the signal type that is currently being input from the selected input source to the surround mode that matches the signal type (e.g., Dolby Pro Logic II, Dolby Digital, DTS, or DTS Neo:6). If pressed, the corresponding settings in the “Input Setup” menu for the selected input source is also changed (see page 54).

If the SURROUND button is pressed

- **While playing back DTS sources**
Each time you press the button, the DTS-ES setting switches from: Auto → On → Off.

Auto: When a DTS source with a DTS-ES flag (ID signal for DTS-ES) is input, the listening mode changes automatically to DTS-ES Discrete 6.1 or DTS-ES Matrix 6.1. If the DTS source has no DTS-ES flag, the source is played in DTS mode.

On: When a DTS source with a DTS-ES flag is input, the listening mode changes automatically to DTS-ES Discrete 6.1 or DTS-ES Matrix 6.1. If the DTS source has no DTS-ES flag, the source is played in DTS-ES Matrix 6.1.

Off: DTS sources are always played in the DTS mode. The DTS-ES modes are not used even when the DTS source has the DTS-ES flag.

- **While playing back Dolby Digital (Multichannel) sources**
Select whether or not to play back Dolby Digital sources using the matrix 6.1-channel decoder when using surround back speakers.

Each time you press the button, the Dolby Digital EX setting switches from: Auto → On → Off.

Auto: Sources with an EX flag (ID signal for Dolby Digital) are automatically played back in Dolby Digital EX. If the source has no EX flag, the source is played back in Dolby Digital.

On: When a Dolby Digital source with an EX flag is input, the listening mode changes automatically to Dolby Digital EX. If the Dolby Digital source has no EX flag, the source is played in the Dolby Digital EX.

Off: Dolby Digital EX playback is not performed even if an EX flag exists. (Playback is the normal Dolby Digital playback.)

Be aware that if the surround channel is monaural or there is no surround channel, the source is played back in Dolby Digital regardless of this setting.

- **While playing back Analog/PCM sources or Dolby Digital 2-channel sources**

Each time you press the button, the Dolby Digital setting switches from: Pro Logic II Movie → Pro Logic II Music → DTS Neo6:Cinema → DTS Neo6:Music.

If “None” is selected for the surround speaker setting in the “Speaker Config” menu, DTS Neo:6 Music will not appear.

Listening Modes

THX: Changes the listening mode to the THX listening mode.

If the THX listening mode is selected

- **While playing back Dolby Digital sources**
Switches the THX Surround EX mode (Auto → On → Off) if the source is a THX Surround EX-compatible source.
- **While playing back Analog/PCM sources**
Switches the decoding mode (Pro Logic II Movie → DTS Neo6:Cinema) for THX processing.
- **While playing back DTS sources**
Switches the DTS-ES mode from Auto → On → Off. Changing the DTS-ES mode allows you to enjoy the DTS THX Cinema, DTS-ES Discrete 6.1 THX Cinema, and DTS-ES Matrix 6.1 THX Cinema surround systems.

Be aware that if surround back speakers are not connected, or if the Surr Back/Zone 2 setting of the Surr Back/Zone 2 Sub-menu is set to “Zone 2,” the THX Surround EX, DTS-ES Discrete 6.1, or DTS-ES Matrix 6.1 listening modes cannot be selected.

ALL ST (remote controller only): Changes the listening mode for the signal type that is currently being input from the selected input source to the All Ch Stereo listening mode. If pressed, the corresponding settings in the “Input Setup” menu for the selected input source is also changed (see page 54).

DSP: Changes the listening mode for the signal type that is currently being input from the selected input source as shown below.

Orchestra → Unplugged → Studio-Mix → TV Logic → All Ch Stereo → Mono → T-D → Mono Movie → Enhance → Orchestra.

If pressed, the corresponding settings in the “Input Setup” menu for the selected input source is also changed (see page 54).

Each press of the DSP ► button on the remote controller switches the listening modes just like the DSP button on the TX-SR701/701E.

On the other hand, each press of the ◀ DSP button switches the listening modes in reverse order.

Re-EQ function for movies (TX-SR701/701E only)

Re-EQ (re-equalization) takes the edginess or “brightness” out of your home cinema sound to compensate for the fact that sound mixed for theaters may sound too bright when played back through speakers in the home environment.

This can be set to either “On” or “Off.”

This function only works in the THX, Dolby Digital, Dolby Digital EX, Dolby Pro Logic II Movie, DTS, DTS-ES Discrete 6.1, DTS-ES Matrix 6.1, DTS Neo:6 Cinema, All Ch Stereo, Mono listening modes.

Note:

Dolby Pro Logic II Movie, DTS Neo:6 Cinema, Dolby Digital, and DTS are only enabled for multichannel playback.

Listening Modes

TX-SR601/601E

Listening mode buttons

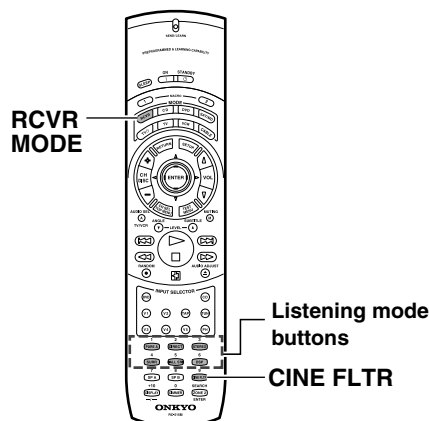
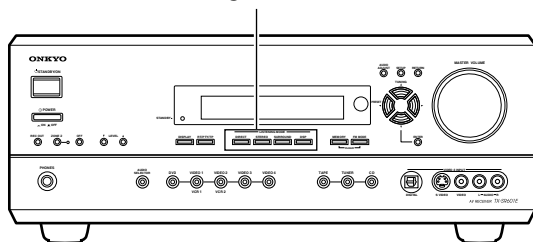

Selecting a listening mode (TX-SR601/601E)

- Refer to pages 46, 47 for more details of listening modes.
- Refer to page 54 for sources and listening modes.
- When playing Dolby Digital or DTS software, the listening mode will automatically change to Dolby Digital or DTS.

Tip:

You can set in advance a different listening mode for each input source. For more details, see page 54 .

When using the remote controller, first press the RCVR MODE button before preceding to the step below.

Press one of the listening mode buttons to select the listening mode.

TX-SR601/601E



Remote controller

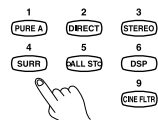

DIRECT: Changes the listening mode for the signal type that is currently being input from the selected input source to the Direct listening mode. If pressed, the corresponding settings in the “Input Setup” menu for the selected input source is also changed (see page 54).

STEREO: Changes the listening mode for the signal type that is currently being input from the selected input source to the Stereo listening mode. If pressed, the corresponding settings in the “Input Setup” menu for the selected input source is also changed (see page 54).

SURROUND (SURR): Changes the listening mode for the signal type that is currently being input from the selected input source to the surround mode that matches the signal type (e.g., Dolby Pro Logic II, Dolby Digital, DTS, or DTS Neo:6). If pressed, the corresponding settings in the “Input Setup” menu for the selected input source is also changed (see page 54).

If the SURROUND button is pressed

- **While playing back DTS sources**
Each time you press the button, the DTS-ES setting switches from: Auto → On → Off.

Auto: When a DTS source with a DTS-ES flag (ID signal for DTS-ES) is input, the listening mode changes automatically to DTS-ES Discrete 6.1 or DTS-ES Matrix 6.1. If the DTS source has no DTS-ES flag, the source is played in DTS mode.

On: When a DTS source with a DTS-ES flag is input, the listening mode changes automatically to DTS-ES Discrete 6.1 or DTS-ES Matrix 6.1. If the DTS source has no DTS-ES flag, the source is played in DTS-ES Matrix 6.1.

Off: DTS sources are always played in the DTS mode. The DTS-ES modes are not used even when the DTS source has the DTS-ES flag.

- **While playing back Dolby Digital (Multichannel) sources**
Select whether or not to play back Dolby Digital sources using the matrix 6.1-channel decoder when using surround back speakers.

Each time you press the button, the Dolby Digital EX setting switches from: Auto → On → Off.

Auto: Sources with an EX flag (ID signal for Dolby Digital) are automatically played back in Dolby Digital EX. If the source has no EX flag, the source is played back in Dolby Digital.

On: When a Dolby Digital source with an EX flag is input, the listening mode changes automatically to Dolby Digital EX. If the Dolby Digital source has no EX flag, the source is played in the Dolby Digital EX.

Off: Dolby Digital EX playback is not performed even if an EX flag exists. (Playback is the normal Dolby Digital playback.)

Be aware that if the surround channel is monaural or there is no surround channel, the source is played back in Dolby Digital regardless of this setting.

- **While playing back Analog/PCM sources or Dolby Digital 2-channel sources**

Each time you press the button, the Dolby Digital setting switches from: Pro Logic II Movie → Pro Logic II Music → DTS Neo6:Cinema → DTS Neo6:Music.

If “None” is selected for the surround speaker setting in the “Speaker Config” menu, DTS Neo:6 Music will not appear.

ALL ST (remote controller only): Changes the listening mode for the signal type that is currently being input from the selected input source to the All Ch Stereo listening mode. If pressed, the corresponding settings in the “Input Setup” menu for the selected input source is also changed (see page 54).

Listening Modes

DSP: Changes the listening mode for the signal type that is currently being input from the selected input source as shown below.

Orchestra → Unplugged → Studio-Mix → TV Logic → All Ch Stereo → Mono → T-D → Mono Movie → Enhance → Orchestra.

If pressed, the corresponding settings in the “Input Setup” menu for the selected input source is also changed (see page 54).

Original filter (CinemaFILTER) loading for movies (TX-SR601/601E only)

The CinemaFILTER function gently decreases the level of the extreme high frequencies, compensating for overly-bright sounding motion picture soundtracks. Select this function if the sound from the front speakers is too bright.

This function only works in the Dolby Digital, Dolby Digital EX, Dolby Pro Logic II Movie, DTS, DTS-ES Discrete 6.1, DTS-ES Matrix 6.1, DTS Neo:6 Cinema, All Ch Stereo, Mono listening modes.

Press the CINE FLTR button on the remote controller.

The current setting is displayed. Press the button again to change the setting.

On: The CinemaFILTER function is used during playback.

Off: The CinemaFILTER function is not used during playback.

Note:

Dolby Pro Logic II Movie, DTS Neo:6 Cinema, Dolby Digital, and DTS are only enabled for multichannel playback.

Input Setup

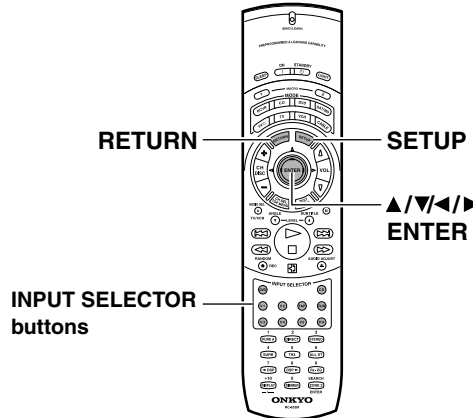
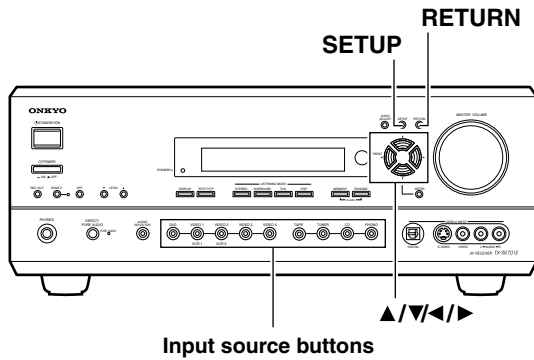

This menu allows you to make the various settings concerning the signals input from the various input sources that you use with the TX-SR701/701E/601/601E. The settings made in this menu are valid for the input source that is currently selected with the input source buttons at the front panel and, therefore, these settings are made separately for each input source.

Setup Procedure

1. Select the desired input source.

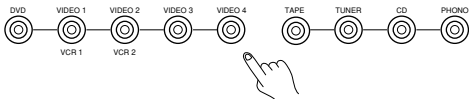

2. Press the SETUP button on the front panel or SETUP button on the remote controller.

The main menu appears.

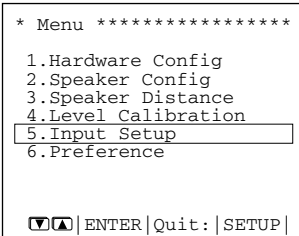

5. Input Setup

3. Use the ▲ and ▼ cursor buttons to select “5. Input Setup” and then press the ENTER button.

The “Input Setup” menu appears.

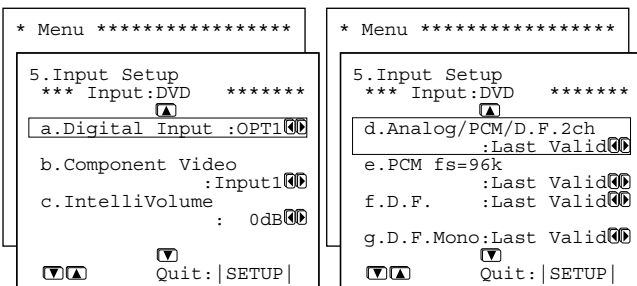

D. Input : OPT1 2ch : LastValid

4. Use the ▲ and ▼ cursor buttons to select an item and then use the ▶ and ◀ cursor buttons to set the desired value.

Press the RETURN button to return to the main menu.

Press the SETUP button on the front panel or SETUP button on the remote controller to exit the Setup menu.

a. Digital Input

This setting tells the TX-SR701/701E/601/601E which input source button on the front panel is connected with which digital input jack on the rear panel.

For example, if the input source selected at the front panel is CD and the compact disc player is connected to DIGITAL INPUT OPTICAL 2, then select “OPT2” here. If the input source selected is not connected to a digital input, then select “----.”

OPT1, 2: Select if the input source is connected to either of the DIGITAL INPUT OPTICAL 1 or 2 jack.

COAX: Select if the input source is connected to the DIGITAL INPUT COAXIAL jack.

----: Select if the input source is not from a digital input jack.

The default settings are given below.

Input source	Digital input
CD	COAX
PHONO*	----
TAPE	----
DVD	OPT 1
VIDEO 1	----
VIDEO 2	----
VIDEO 3	OPT 2

----: Available for digital input but not set in initial settings.

* TX-SR701/701E only

Notes:

- When you select “TUNER” for input, you cannot assign digital input to “TUNER.”
- Since VIDEO 4 is fixed to the optical digital terminal on the front panel, this item will be disabled if VIDEO 4 is selected.

Input Setup

b. Component Video

The video signal from the input jacks set at the “b. Component Video” setting is output to the COMPONENT VIDEO OUT jacks. Use this setting if you connect monitors like TV to the COMPONENT VIDEO OUT jacks on the TX-SR701/701E/601/601E.

For example, when you connect the DVD player to the COMPONENT VIDEO INPUT 1 jacks, select “DVD” as input source and set “b. Component Video” to “INPUT 1.”

The default settings are given below.

Input source selected	Component video input
CD	Last
PHONO*	Last
TUNER	Last
TAPE	Last
DVD	INPUT 1
VIDEO1	INPUT 2
VIDEO 2	INPUT 2
VIDEO 3	INPUT 2
VIDEO 4	INPUT 2

* TX-SR701/701E only

INPUT 1: Selects when the video device is connected to the COMPONENT VIDEO INPUT 1 jacks.

INPUT 2: Selects when the video device is connected to the COMPONENT VIDEO INPUT 2 jacks.

Last: Select to have the video of the previous input source continued.

c. IntelliVolume

This setting allows you to adjust for the volume differences between your various input source components.

When switching input sources, you may find that the output level for different components or input sources connected to the TX-SR701/701E/601/601E is different even though the main volume setting is the same. Under normal circumstances, you would then have to change the volume setting each time you change the input source. This Intelli Volume setting allows you to preset a volume level for each input source separately so that when you do switch from one input source to another, the TX-SR701/701E/601/601E adjusts the volume accordingly and the volume stays the same. If the volume is quieter than that of other sources, increase it with the ► cursor button, and if it is louder than that of other sources, decrease it with the ◀ cursor button.

The IntelliVolume can be adjusted between -12 and +12 decibels.

Input Setup

The listening mode will be reset to the mode you set here after turning on the TX-SR701/701E/601/601E even if you change the listening mode using the LISTENING MODE buttons.

When you set this setting to “Last Valid”, the listening mode will be the one you used before.

Notes:

- For “e. PCM fs 96kHz source” “f. Digital Format source” “g. D. F. Mono source”
These settings will be disabled if “----” is selected at the “Digital Input” setting.
- For “e. PCM fs 96kHz source” “g. D. F. Mono source”
The selected listening mode will be applied to all the input source signals of the same type.

d. Analog/PCM/D. F. 2ch source

This sets the listening mode for analog, PCM, or Digital Format 2ch sources.

Analog sources consist of LP records, FM and AM broadcasts, cassette tapes, and the such. PCM (Pulse Code Modulation) is one form of digital audio signals and is recorded directly onto compact discs and DVDs without compression.

Digital format 2ch is a 2-channel digital source, such as DVD or LD which is recorded in 2-channel Dolby Digital format (but for PCM).

e. PCM fs 96kHz source

This sets the listening mode for Digital PCM sources recorded with a sampling rate of 96 kHz.

f. Digital Format source

This sets the listening mode for Dolby Digital or DTS sources.

g. D. F. Mono source

This setting allows you to select the listening mode for digital mono source.

Digital format mono is monaural digital source, such as DVD or LD which is recorded in Dolby Digital mono format.

Relationship between input source and listening mode

Input source signal	d. Analog/PCM/ D.F. 2ch source	e. PCM fs 96kHz source	f. Digital Format source				g. D.F. Mono source
			Dolby Digital	DTS			Dolby Digital/DTS Monaural
			5.1 ch	5.1 ch	6.1 ch	96/24	
Type of software	Tape, Video tape, Vinyl, Tuner, CD, MD, DVD (Stereo), LD, Digital Satellite	DVD (96kHz/ 24bit)	Dolby Digital Digital Satellite	CD, LD, DVD	DVD	DVD	DVD
Listening Mode							
Pure Audio *1	● *2	●					
Direct	● *2	●					
Stereo	●	●	●	●	●	●	
Mono	● *2						●
T-D	●		●	●	●	● *6	
Surround	PL II Movie PL II Music DTS Neo:6 Cinema DTS Neo:6 Music PL II (T-D)		Dolby Digital Dolby Digital EX *3	DTS DTS-ES Matrix 6.1 *4	DTS DTS-ES Discrete 6.1 *4	DTS 96/24 *5 DTS-ES *6	
THX *1	PL II (THX) DTS Neo:6 (THX)		THX Cinema THX Surr EX	THX Cinema DTS-ES Matrix 6.1 (THX)	THX Cinema DTS-ES Discrete 6.1 (THX)	THX Cinema *6 DTS-ES (THX) *6	
Orchestra	●		●	●	●	● *6	
Unplugged	●		●	●	●	● *6	
Studio-Mix	●		●	●	●	● *6	
TV Logic	●		●	●	●	● *6	
Enhance	●		●	●	●	● *6	
Mono Movie	●						●
All Ch St	●						

*1 TX-SR701/701E only

*2 Not Available when the input source is the D.F. 2ch source.

*3 Available when the Dolby Digital EX setting is set to “Auto” with the software having an EX flag or set to “On” (see pages 48, 50).

*4 Available when the DTS-ES setting is set to “Auto” with the software having a DTS-ES flag or set to “On” (see pages 48, 50).

*5 If the source cannot be mixed down, the listening mode will change to the DTS 96/24.

*6 Plays back in ordinary DTS (48 kHz) format.

Note:

You may not be able to select all the listening modes shown here depending on your speaker configuration or the selected input source.

Hardware Setup

Hardware Config

To display the Hardware Config menu:

1. Display the main menu.
2. Use the ▲ and ▼ cursor buttons to select “1. Hardware Config” and then press the ENTER button. The “Hardware Config” menu appears.

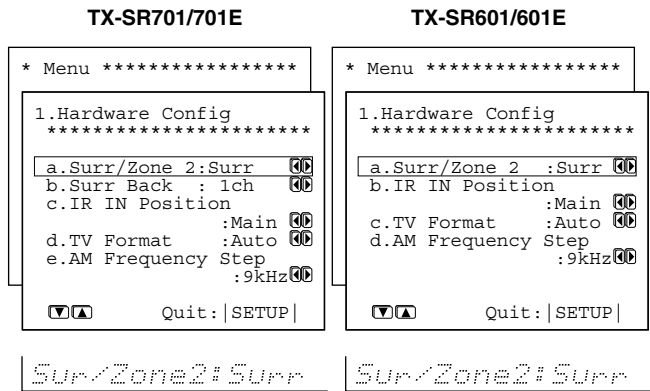

a. Surr/Zone 2

If you connect the Zone 2 speakers to the ZONE 2 SPEAKERS terminals or the amplifier connected to the ZONE 2 PRE OUT (TX-SR701/701E only) terminals, set the Surr/Zone 2 setting to “Zone 2.”

Surr: In this setting, sound will not be output from the Zone 2 speakers which is connected to the ZONE 2 SPEAKERS terminals or the amplifier connected to the ZONE 2 PRE OUT (TX-SR701/701E only) terminals. In the main room, 6.1-channel playback will always be available.

Zone 2: In this setting, when you are not using the Zone 2, 6.1-channel playback will be available for the main room. However, while you use the Zone 2, 6.1-channel playback will not be available for the main room (2ch stereo playback only).

b. Surr Back (TX-SR701/701E only)

Specify whether you use one surround back speaker or two.

1ch: Selects when you connect one surround back speaker to the SURROUND BACK SPEAKER terminals on the TX-SR701/701E.

2ch (PRE OUT): Selects when you connect two surround back speakers to the power amplifier connected to the SURR BACK PRE OUT terminals on the TX-SR701/701E.

Note:

Be sure to use either one or two surround back speakers. Connecting surround back speakers to both the SURROUND BACK SPEAKER terminals on the TX-SR701/701E and the power amplifier will not produce correct surround sound effect.

c. IR IN Position (TX-SR701/701E)

b. IR IN Position (TX-SR601/601E)

Use this setting when you have a remote control sensor connected to the IR IN terminal. The setting in this menu tells the TX-SR701/701E/601/601E whether the remote control sensor is being used for operation of the TX-SR701/701E/601/601E in the main zone or the remote zone (Zone 2).

Main: Select when you are using the remote control sensor for operation with the remote controller in the main zone.

Zone 2: Select when you are using the remote control sensor for operation with the remote controller in the remote zone (Zone 2).

d. TV Format (TX-SR701/701E)

c. TV Format (TX-SR601/601E)

(For all models other than USA and Canadian models)

The default setting is “Auto,” which means that the television format is detected and automatically set by the TX-SR701/701E/601/601E. However, if you know the correct format, you can use this setting to choose either PAL or NTSC so that no time is wasted on detection.

e. AM Frequency Step (TX-SR701/701E)

d. AM Frequency Step (TX-SR601/601E)

This setting only appears on the worldwide model. It determines the increment amount or decrement amount when adjusting the AM tuner frequency. The initial setting is 9 kHz, and this needs only to be changed if you are using the TX-SR701/701E/601/601E in a 10-kHz region.

Preference

Preference

To display the Preference menu:

1. Display the main menu.
2. Use the ▲ and ▼ cursor buttons to select “6. Preference” and then press the ENTER button.

The “Preference” menu appears.

TX-SR701/701E
TX-SR601/601E

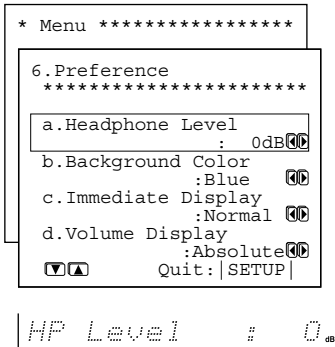

a. Headphone Level

You can adjust the volume output from the headphones so that it matches the level output from the speakers. The headphone volume can be adjusted between -12 and +12 decibels.

b. Background Color

Select either Blue, Green, Magenta, or Red as the background color when the OSD Setup Menu is displayed.

c. Immediate Display

Off: Select to turn off the immediate display of operations.

Normal: Select to display operations in the bottom right corner of a TV screen with a 4:3 aspect ratio.

Wide: Select to display operations in the bottom right corner of a TV screen with a 16:9 aspect ratio.



Hint:

If this is set to “Off,” the background color will not be displayed even when there is no video signal input.

d. Volume Display

You can choose from two ways of displaying the volume setting on screen.

Absolute: This displays the volume with a minimum of 0 for no sound and a maximum of 100. As a reference, the volume setting of Ref (82) is equivalent to 0 decibels for the relative display method.

Relative: This displays the volume as a decibel value on a scale with a designated reference point that is displayed as 0, which equals the volume setting of 82 of the absolute display method. With this display method, the minimum value is $-\infty$, the next highest is -81, and the maximum value is +18.

Audio Adjust

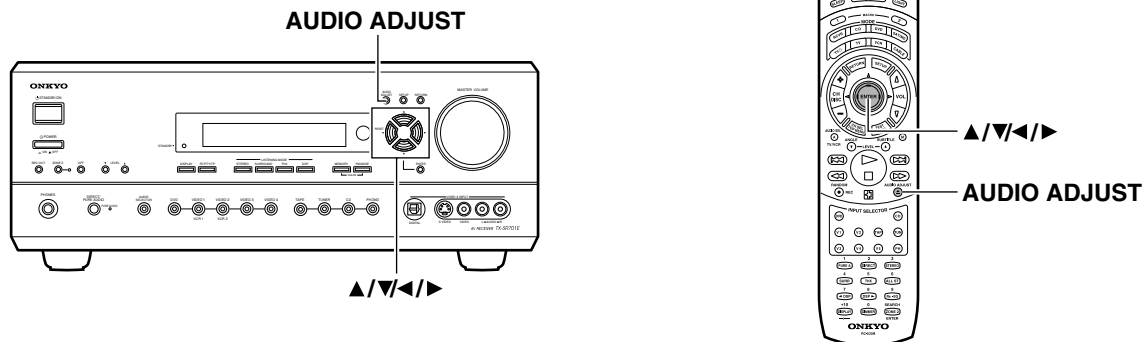

These settings are enabled depending on the listening mode or input signal.

Setup Procedure

1. Press the AUDIO ADJUST button.

The Audio Adjust settings appear in the front display and on the monitor.

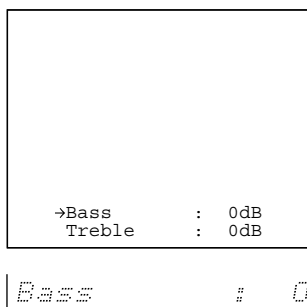

Note:

The items that appear in the menu depend on the currently selected listening mode or the input signal.

2. Use the ▲ and ▼ cursor buttons to select the item that you want to set.

3. Use the ◀ and ▶ cursor buttons to set the value.

Setting	Values	Initial value
Bass	-12 to +12	0
Treble	-12 to +12	0
LFE Level*	-∞, -10 to 0 dB	0 dB
Double Bass	On, Off	On
Late Night	Off, Low, High	Off
Center Image	0, 1, 2, 3, 4, 5	3
Panorama	On, Off	Off
Dimension	0, 1, 2, 3, 4, 5, 6	3
Center Width	0, 1, 2, 3, 4, 5, 6, 7	3
Front Effect	On/Off	On
Reverb Level	Low/Middle/High	Middle
Reverb Time	Short/Middle/Long	Middle
Input Channel	L+R/Left/Right	L+R
Academy*	On/Off	Off
Listening Angle	20°/40°	40°
Center	On/Off	Off
Front Expand	On/Off	Off

Setting	Values	Initial value
Dialog Enhance	On/Off	Off
Virtual Surround Level	-3 to +3	0

* TX-SR701/701E only

Bass, Treble

Separately adjust the bass and treble settings in 2-step increments. The Bass and Treble adjustments are only enabled for the front left and right speakers.

Note:

If Direct, Pure Audio (TX-SR701/701E only), or THX (TX-SR701/701E only) is selected as the listening mode, these settings cannot be made. To make these settings, first select another listening mode.

Double Bass

The Double Bass function boosts the bass sound by letting the bass sound of "Front L/R" speakers output also from the subwoofer. To enable this function, in the "Speaker Config" menu, set the "Subwoofer" to "Yes" and "FrontL/R" to "Large."

The Double Bass function is effective especially when the input is monaural, 2-channel or PCM 96kHz signal.

On: Select to turn on the Double Bass function.

Off: Select to turn off the Double Bass function.

Late Night

The audio for movies made for the cinema have a large dynamic range; thus, the difference between loud noises and soft noises is great. To hear the quieter sounds such as background noises or human conversations, the movie must be played back at larger volumes. When this setting is set to "High" or "Low," the dynamic range of the sound is narrowed down to allow you to easily hear minute sounds at low volumes. This function is especially useful if you wish to play a movie at low volumes during the nighttime.

This can be set to either "Off" or "Low," or "High." When this setting is set to "High" or "Low," the dynamic range of the sound is narrowed down to allow you to easily hear minute sounds at low volume.

Off: Select to turn off the Late Night function.

Low: Select to narrow down the dynamic range.

High: Select to further narrow down the dynamic range.

Notes:

- The Late Night function is effective only on Dolby Digital encoded software.
- The depth of the Late Night effect is determined by Dolby Digital software. With some sources, it may produce little or no effect.

Center Image

DTS Neo:6 derives a center channel from two-channel PCM and analog sources.

In cinema mode, for Lt/Rt film soundtracks, sounds steered to the center are subtracted from the left and right channels.

In music mode, the intent in the front channels is less one of steering and more one of stabilizing the front image by augmenting it with a center channel, while preserving the original perspective of the stereo mix. Therefore the derived center is never fully subtracted from the left and right channels.

Center Image is the factor controlling the amount of subtraction. It varies between 0 and 5 in steps of 1 and the default value is 3.

When Center Image=5, the factor is zero and nothing is subtracted from the left and right channels. When Center Image=0, the center channel is subtracted from the left and right channels at half level (-6 dB) for each channel. The signal level sent to the center channel output is not affected by Center Image.

This control should be set based on room layout and personal preferences. A setting of 5 allows the left and right channels to pass through unaltered from the stereo mix. A setting of 0 gives more center channel dominance, which is particularly desirable if listeners are located well off-center. At any setting, the center speaker anchors the image.

Center Image is only enabled when the listening mode is DTS Neo:6 Music.

Pro Logic II Music Panorama (Panorama)

Use this setting to extend the front stereo image to include the surround speakers for an exciting wraparound effect with side wall imaging.

On: Select to turn on the PL II Music Panorama mode.

Off: Select to turn off the PL II Music Panorama mode.

Panorama is only enabled when the listening mode is Dolby Pro Logic II Music.

Pro Logic II Music Dimension (Dimension)

Use this setting to gradually adjust the soundfield forward or backward. The setting of "3" is the normal position. Change the setting to "2" or lower to move the sound space forward setting to "4" or higher to move the sound space backward.

If the stereo recording has excessive broadness or too strong surroundness, move the sound space forward to get the appropriate sound balance. In contrast, if the stereo recording is somewhat felt like monaural or has narrowness, move the sound space backward to get more surroundness.

Dimension is only enabled when the listening mode is Dolby Pro Logic II Music.

Pro Logic II Music Center Width (Center Width)

In Pro Logic II decoding, center signals are output from the center speaker. When the center speaker is not used, the decoder will divide the center signal equally to both the front left and right speakers to create a "phantom" center sound image.

The Pro Logic II Music Center Width mode allows you to adjust from where the center sound image is heard. Using this, you can have the soundfield be heard from the center speaker only, from the front left and right speakers only (as a phantom center sound image), or from all three speakers (center, front left and right) in various level combinations. For home use, applying some width to the center signal will improve the level balance for the center and main speakers, and effect the width of the center sound image, or "weight" of the sound. Many sound recordings processed for stereo playback will be reproduced better by proper control of this setting. The recommended setting for Pro Logic II Music mode is "3." This allows you to easily distinguish the Pro Logic II Music mode from the Pro Logic II Movie mode whose setting is automatically set to "0."

Center Width is only enabled when the listening mode is Dolby Pro Logic II Music.

LFE Level (TX-SR701/701E only)

The level can be adjusted to either $-\infty$ or between -10 and 0 decibels in 1-decibel increments. For Dolby Digital and DTS input source signals, the LFE level set here is used. A setting of 0 decibels is recommended for optimum performance; however, if the source is recorded with the low frequency range too strong, lower this setting as necessary.

Academy Filter (TX-SR701/701E only)

Older monaural film mixes relied on high-frequency rolloff in presentation to sound properly balanced, so that excessive hiss from the grain structure of the film would not be heard. The high-frequency loss was typically due to a combination of optical slit loss, electrical filters, loudspeaker response, and screen loss. Some films have been transferred to video without such a high-frequency rolloff, and thus sound overly bright and hissy.

The TX-SR701/701E/601/601E includes this "Academy filter," which is based on contemporary playback practices for such films over wide-range systems.

This can be set to either "On" or "Off."

Input Channel

This allows you to set which input channel to use for monaural sound.

Auto L+R: Select this under normal circumstances. When the input source is center channel, this center channel is used as the monaural sound input channel. Otherwise, the left and right channels are mixed and the mixed signal is used as the monaural sound input channel.

Left/Right: You will need to select either left or right when playing a video source that contains bilingual data. In such a case, the left and right channels will contain the audio for different languages. Select the channel with the language you desire.

Listening angle

The listening angle is the angle subtended by the front left and right speakers as seen from the listener. The processing for the virtual surround will be based on this angle. In the Theater-Dimensional mode, the setting of 20 and 40 degrees are only for nominal purposes, so select the setting that is closest to your actual listening angle.

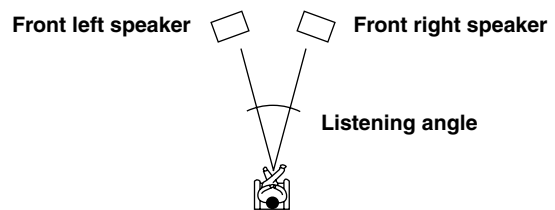

Center

In the Theater-Dimensional mode, if the speaker system has a center speaker, the center channel signal can be output from the center speaker. For instance, in systems where the front left and right speakers are small, use of the center speaker may provide a better sound space and reduce the load on the front speaker. (For the proper soundfield, it is important that the speaker levels and speaker distances among the front right, front left, and center speakers are matched. In order to ensure this, make sure that the settings in the Speaker Distance Sub-menu and Level Calibration sub-menu are set correctly.)

On: Select to have the center channel signal output to the center speaker.

Off: Select to have the center channel signal output to the front left and right speakers (Phantom Center).

Audio Adjust

Front Expander

In the Theater-Dimensional mode, the front expander function spreads out the stereo image in front of the listener. The created stereo image is as if the front speakers have been farther apart for the feeling of a wide sound space. This is especially useful for narrow listening angles of 20 degrees or less.

On: Select to turn on the front expander function to simulate a wider sound space.

Off: Select to turn off the front expander function for a normal sound space.

Virtual Surr Level

In the Theater-Dimensional mode, this setting adjusts the level of the virtual surround signal. This can be set from -3 to +3 decibels. Lowering this setting can improve the sound when the definition is unclear or when the sound feels unnatural.

Dialog Enhance

If the dialog from the center channel is difficult to hear in the Theater-Dimensional mode, use this setting to improve the clarity.

On: Select to enhance the vocal ranges of the center channel signal.

Off: Select to output the center channel signal at the regular level and frequency characteristics.

Front Effect (Orchestra, Unplugged, Studio-Mix, TV Logic, Enhance, Mono Movie)

Some live recordings contain acoustic reverberation. When you play these sources, more reverberation will be applied by the DSP, creating too much reverb effects and the sound loses focus or presence. In this case, set this setting to "Off" so that no reverberation from the DSP will be applied to the sound output from the three front channels. With this setting, the sound source is played as it is without any further reverberation.

Reverb Level (Orchestra, Unplugged, Studio-Mix, TV Logic, Enhance, Mono Movie)

This setting allows you to adjust the depth of acoustic reverberation to match the playback source material, the acoustics of your room, and such other factors.

Select from the three settings "Low," "Middle," and "High."

Reverb Time (Orchestra, Unplugged, Studio-Mix, TV Logic, Enhance, Mono Movie)

Adjust the reverb time to match the source being played back and the acoustics of the room. Select from the three settings "Short," "Middle," and "Long."

Enjoying music in the remote zone

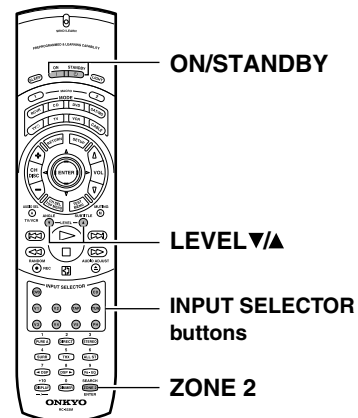
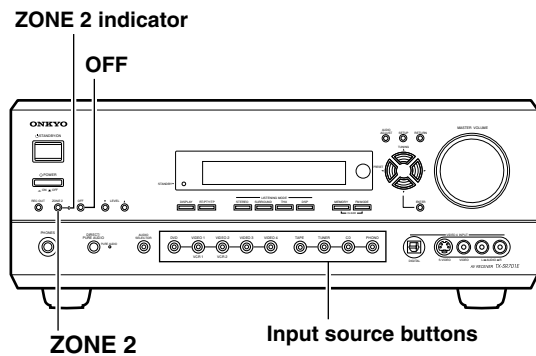

Using the buttons

1. Press the **ZONE 2** button.
2. Select an input source.
After pressing the ZONE 2 button, you must press an input source button within 5 seconds. The ZONE 2 indicator lights.

Ex.: When the CD button is pressed.

Zone2Sel:CD

To select the same source for the remote zone that is selected for the main zone, press the ZONE 2 button again until "Zone2Sel:SOURCE" appears in the display.

Zone2Sel:SOURCE

- When "Zone2Sel:Off" is displayed, the output to the remote zone is turned off.
- When you are not using the remote zone (Zone 2), press the OFF button to turn off the ZONE 2 indicator.

Notes:

- If a sleep time is set with the SLEEP button, the output to the remote zone will also turn off when the sleep time elapses.
- If the source for the main zone is selected as the source for the remote zone and the source for the main zone is changed, then the source for the remote zone will change as well.
- The ZONE 2 terminal is an analog output. Digital signals are not output. If no sound is heard from the selected input source, check if the component is connected to the analog inputs.
- If the REC OUT button is pressed in the main room while someone is using the system in the remote zone, the Zone 2 function will be deactivated and the source will turn off in the remote zone.
- If you select FM (or AM) with the TUNER input source button when the source for the remote zone (Zone 2) is set to AM (or FM), the output for the remote zone also changes to FM (or AM).
- When you are using the remote zone (Zone 2), **RI** system operation will not work.
- In the remote zone, you can only play the source in the 2-channel mode. You cannot play the source in the remote zone in the surround mode.

Using the remote controller

With the TX-SR701/701E/601/601E in the standby state, turn on the output to the remote zone (Zone 2):

After pressing the ZONE 2 button, press the ON button within 5 seconds. The ZONE 2 indicator lights.

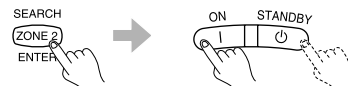

To turn off output to the remote zone (Zone 2), press the ZONE 2 button and then the STANDBY button within 5 seconds.

Select an input source:

After pressing the ZONE 2 button, press an input source button within 5 seconds.

If tuner is selected with the TUN button, you can use the CH button to select a preset radio station.

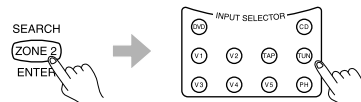

Note:

After you press the ZONE 2 button on the remote controller, the ZONE 2 indicator on the TX-SR701/701E/601/601E flashes for five seconds. During this time, you will not be able to perform operations in the main zone using the remote controller.

Adjusting the volume for the remote zone

When the remote zone (Zone 2) speakers are connected to the ZONE 2 SPEAKERS terminals, or to an amplifier connected to the ZONE 2 PRE OUT terminals, adjust the volume as shown below.

Press the LEVEL ▲ / ▼ buttons on the front panel.

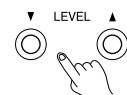

Adjusting the volume (using the remote controller):

After pressing the ZONE 2 button, the ZONE 2 indicator on the TX-SR701/701E/601/601E will flash for 5 seconds. During this time press the LEVEL ▲ / ▼ button.



Recording

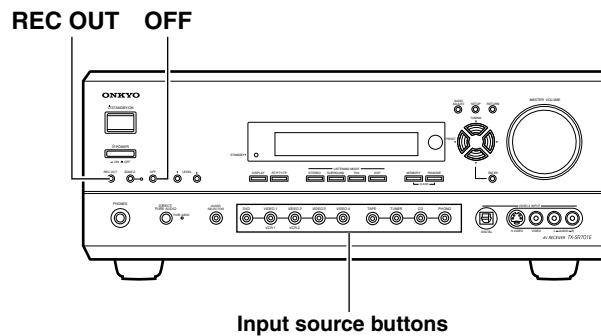

Notes:

- You cannot record the surround effects.
- Digital signals input to the DIGITAL INPUT (COAXIAL) and DIGITAL INPUT (OPTICAL) inputs will be output to the DIGITAL OUTPUT (COAXIAL) and DIGITAL OUTPUT (OPTICAL) output.
- There are some restrictions on recording digital signals. When making digital recordings, consult the instruction manual that came with your digital recording equipment (e.g., MD recorder or DAT deck) to know what restrictions are imposed.
- You cannot record the source connected to the 5.1-channel input jacks.
- If you change the input source during recording, you will record the signals from the newly selected input source.
- Digital input signals are only output to the digital outputs and analog input signals are only output to the analog outputs. There is no conversion from digital to analog or vice versa. When connecting CD players and other digital components, do not connect only the digital terminals, but the analog ones as well.

Note:

Be aware that if you change the input source that you are watching (or listening to), the selected source will be recorded.

Recording a source different from that you are listening to:

The TX-SR701/701E/601/601E allows you to listen to one source while recording the signal from another source. The procedure below uses the example of recording the audio from a CD player while watching the input from a DVD player.

1. While playing the DVD, press the **REC OUT** button.



2. Within 5 seconds, press the input source button of the source that you wish to record.

In this example you would press the CD source button. The signal from the CD player is now output to the TAPE OUT jacks.

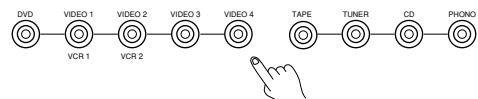

Recording the input source (REC OUT selector)

When using the TX-SR701/701E/601/601E to record a source, you must select that source to be output from the TAPE OUT jacks.

Recording the same source that you are listening to:

1. Press the input source button for the source that you want to record.

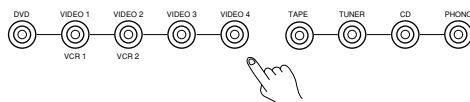

2. Press the **REC OUT** button repeatedly until "Rec Sel : SOURCE" appears in the front display.



Rec Sel : SOURCE

3. Start recording at the recording device connected to the TAPE OUT jacks.

3. Start recording at the recording device connected to the TAPE OUT jacks.

You can press the REC OUT button to display which input source is selected for recording. When "Rec Sel: Off" is displayed, no signal is output for recording.

To confirm the settings, press the REC OUT button. The current settings will appear for 5 seconds in the front display.

To turn off the Rec Out, press the REC OUT button and then press the OFF button within five seconds.

Notes:

- You cannot use the REC OUT selector to record video signals.
- Be aware that the ZONE 2 and REC OUT selectors use the same circuit and therefore cannot be used at the same time.
- Even if you change the input source that you are listening to, the input source that is selected for recording will not change. However, if you have selected FM (or AM) as the source to be recorded and the AM (or FM) source button is pressed, the source being recorded will be changed to the AM (or FM) input signal.

Recording

Recording both the audio and video

The TX-SR701/701E/601/601E also allows you to record the audio and video signals output from the VIDEO OUT 1 and 2 jacks.

1. **Press the input source button for the source you want to record.**

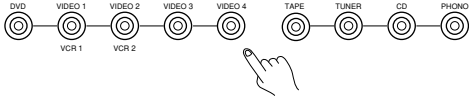

2. **Start recording at the recording device connected to the VIDEO OUT 1 and 2 jacks.**

Note:

Be aware that if you change the input source that you are watching (or listening to), the selected source will be recorded.

Hint

You can also record the video from one source and the audio from another source together to make your own home movies and the like. For example, if you want to record the video from a video camera connected to VIDEO 4 and the audio from a CD player connected to CD IN, at step 1 above, press the VIDEO 4 source button and then the CD source button.

Using remote controller

* Diagram for RC-533M

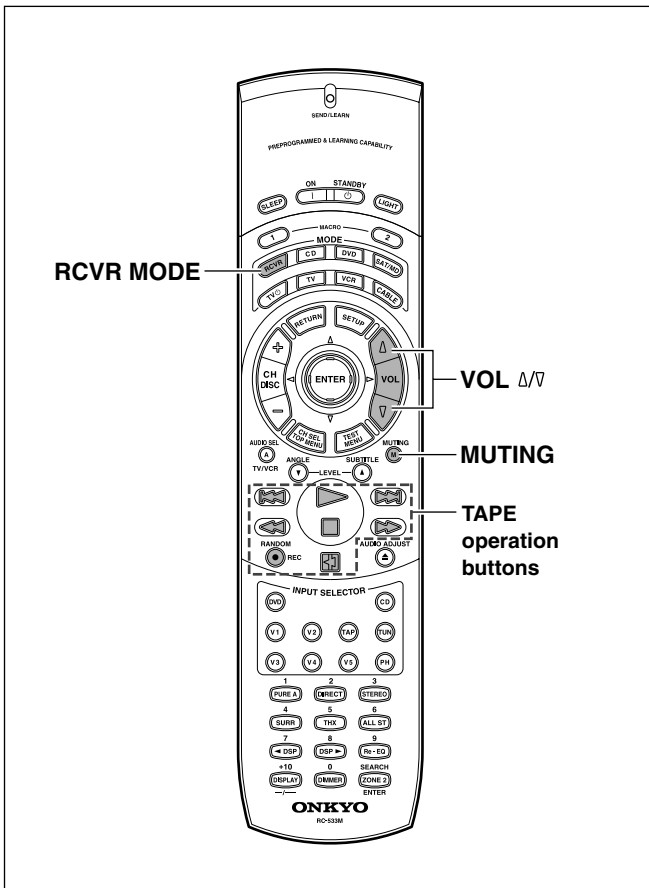
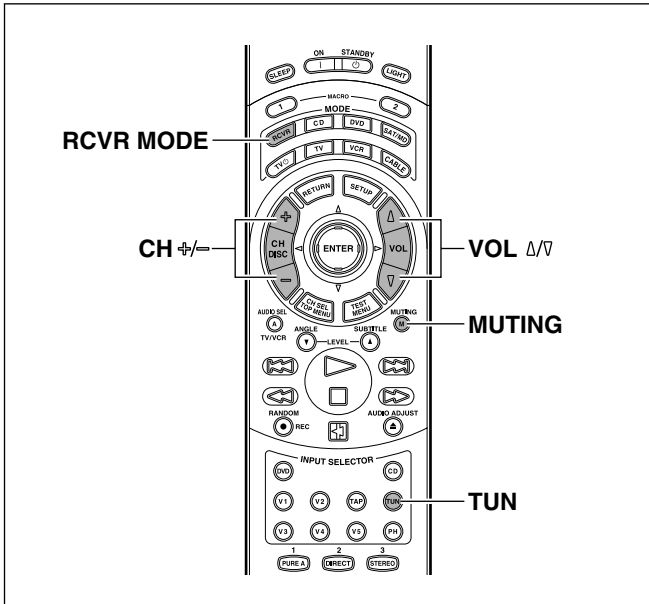

Overview

The RC-533M/515M remote controller is a useful tool that can not only operate the TX-SR701/701E/601/601E, but also all the other components of your home theater as well. To operate any component, first press the Mode button on the remote controller that corresponds to the component that you wish to control. Then simply press the desired operation button and the component will operate accordingly. For example, if you wish to select the CD input source at the TX-SR701/701E/601/601E with the remote controller, first press the RCVR MODE button to select the TX-SR701/701E/601/601E and then press the CD (INPUT SELECTOR) button.

Calling up a preset radio station

1. Press the RCVR MODE button.
The RCVR MODE button lights.
2. Press the TUN input selector button.
3. Press the desired operation button.

Operation buttons:

CH +/-: Selects the desired preset station number

You may also use the following buttons:

VOL Δ/V: Adjusts volume at TX-SR701/701E/601/601E

MUTING: Activates muting function at TX-SR701/701E/601/601E

Controlling an Onkyo cassette tape deck

The RI connector of the Onkyo cassette tape deck must be connected to the TX-SR701/701E/601/601E (see page 24).

1. Press the RCVR MODE button.
The RCVR MODE button lights.
2. Press the desired operation button.

The buttons shaded in the figure to the left are the operation buttons that can be used to control an Onkyo cassette tape deck.

Operation buttons:

- ▷: Play
- : Stop
- ◀: Rewind
- ▶: Fast forward
- ⏮: Skips to beginning of next track during playback
- ⏪: Skips to beginning of current track during playback
- REC ●: Record/Pause
- ⏮: Reverse playback

You may also use the following buttons:

VOL Δ/V: Adjusts volume at TX-SR701/701E/601/601E

MUTING: Activates muting function at TX-SR701/701E/601/601E

Note:

Even for devices with the ⏮ and ⏪ buttons, signal discrepancies may cause them not to work properly.

Controlling an Onkyo DVD player

The **RI** connector of the Onkyo DVD player must be connected to the TX-SR701/701E/601/601E (see page 24).

1. Press the DVD MODE button.

The DVD MODE button lights.

2. Press the desired operation button.

The buttons shaded in the figure to the left are the operation buttons that can be used to control an Onkyo DVD player.

Operation buttons:

ON: Turns DVD player on and off

STANDBY: Turns DVD player off (Some sets may not respond to this button. In this case, use the ON button to put the DVD player in the standby state.)

SETUP: Displays the OSD of the DVD player

Δ/∇/◀/▶: Moves cursor in the OSD Menu of the DVD player

ENTER: Enter button for the OSD Menu of the DVD player

RETURN: Return button for the OSD Menu of the DVD player

TOP MENU or MENU: Displays menu screens recorded on DVD media

DISC ◀/▶: Selects disc in DVD changer

AUDIO SEL: Selects audio or language track (if recorded on the DVD)

ANGLE: Selects a camera angle (if recorded on the DVD)

SUBTITLE: Selects subtitle language (if recorded on the DVD)

SEARCH: Searches for location on disc to start playback

RANDOM: Random playback

⏮: Chapter/Track down

⏭: Chapter/Track up

▶: Play

⏹: Stop

⏪: Fast reverse

⏩: Fast forward

⏸: Pause

⏴: Opens/closes the disc tray

0, 1 to 9, +10: Numeric keys

You may also use the following buttons:

VOL Δ/∇: Adjusts volume at TX-SR701/701E/601/601E

MUTING: Activates muting function at TX-SR701/701E/601/601E

Note:

When operating an Onkyo DVD player directly with the remote controller without connecting the **RI** terminals, pre-programming is necessary (see page 67).

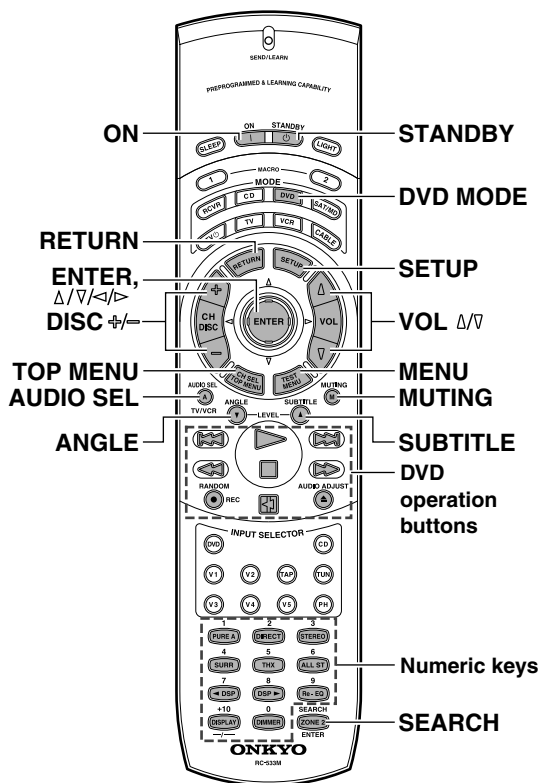

Using remote controller

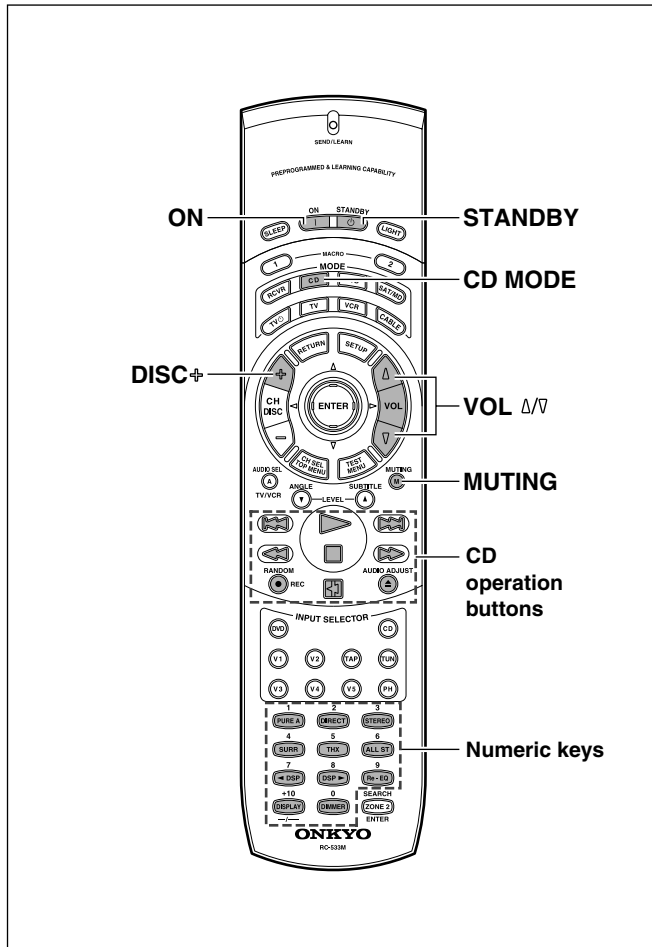

Controlling an Onkyo CD player

The **RI** connector of the Onkyo compact disc player must be connected to the TX-SR701/701E/601/601E (see page 24).

1. Press the CD MODE button.

The CD MODE button lights.

2. Press the desired operation button.

The buttons shaded in the figure to the left are the operation buttons that can be used to control an Onkyo compact disc player.

Operation buttons:

ON: Turns on and off the compact disc player (same as **STANDBY** button on the remote controller)

DISC +: Selects a disc in the CD changer

: Track down

: Track up

: Play

: Stop

: Skip backward

: Skip forward

: Pause

: Opens/closes the disc tray

0, 1 to 9, +10: Numeric keys

RANDOM: Random playback

You may also use the following buttons:

VOL Δ/∇: Adjusts volume at TX-SR701/701E/601/601E

MUTING: Activates muting function at TX-SR701/701E/601/601E

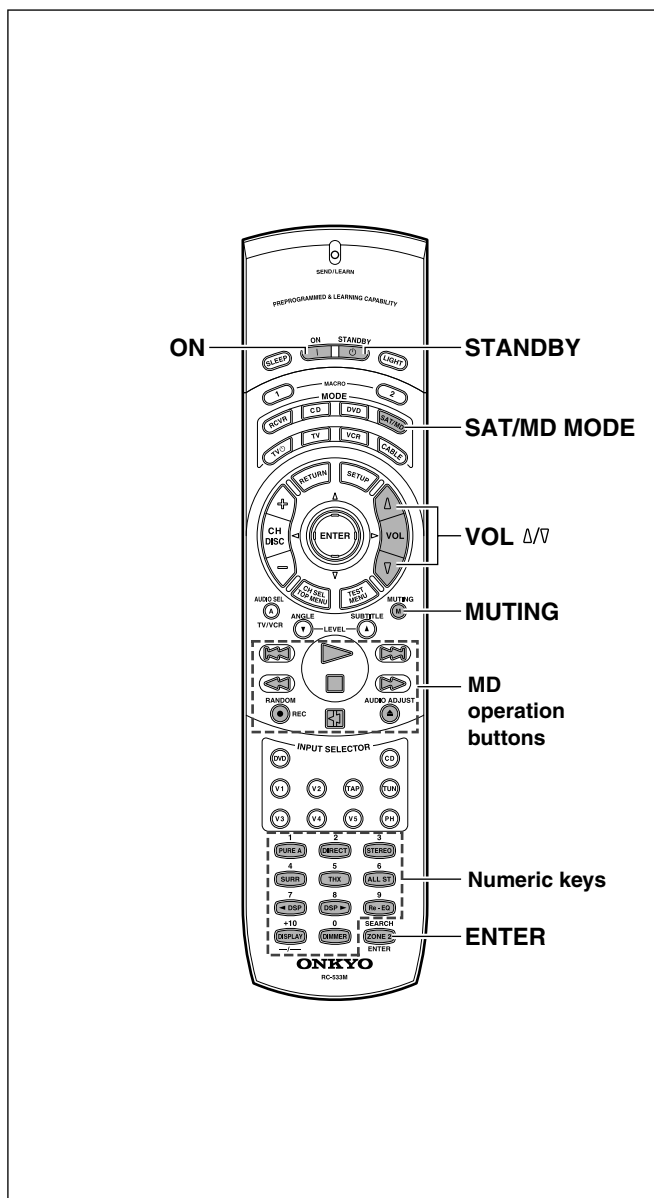

Controlling an Onkyo MD recorder

The **RI** connector of the Onkyo MD recorder must be connected to the TX-SR701/701E/601/601E (see page 24).

1. Press the **SAT/MD MODE** button.

The SAT/MD MODE button lights.

2. Press the **desired operation button**.

The buttons shaded in the figure to the left are the operation buttons that can be used to control an Onkyo MD recorder.

Operation buttons:

ON: Turns on and off MD player (same as **STANDBY** button on the remote controller)

: Track down

: Track up

: Play

: Stop

: Skip backward

: Skip forward

REC ●: Record

: Pause

: Eject

1 to 9, 0, --/--: Numeric keys

ENTER: Enters the settings

You may also use the following buttons:

VOL Δ/V: Adjusts volume at TX-SR701/701E/601/601E

MUTING: Activates muting function at TX-SR701/701E/601/601E

Note:

The **SAT/MD** button is used for operating satellite tuners and Onkyo MD recorders. Be aware that if you enter the preset code for a satellite tuner as shown on page 65, then this button cannot be used to operate Onkyo MD recorders.

If this is the case, to operate an Onkyo MD recorder, you must first erase the satellite tuner code by following the directions given in “Erasing all the commands programmed under a **MODE** button” on page 72.

Entering a pre-programming code

The remote controller has three learning functions. One is entering the pre-programmed code for a remote controller of another manufacturer. Another is the normal learning function that enables the remote controller to learn the codes directly from other remote controllers (see page 71). And the last is a macro learning function that enables you to program a series of operations into the remote controller so that the operations can all be performed at once by pressing one button.

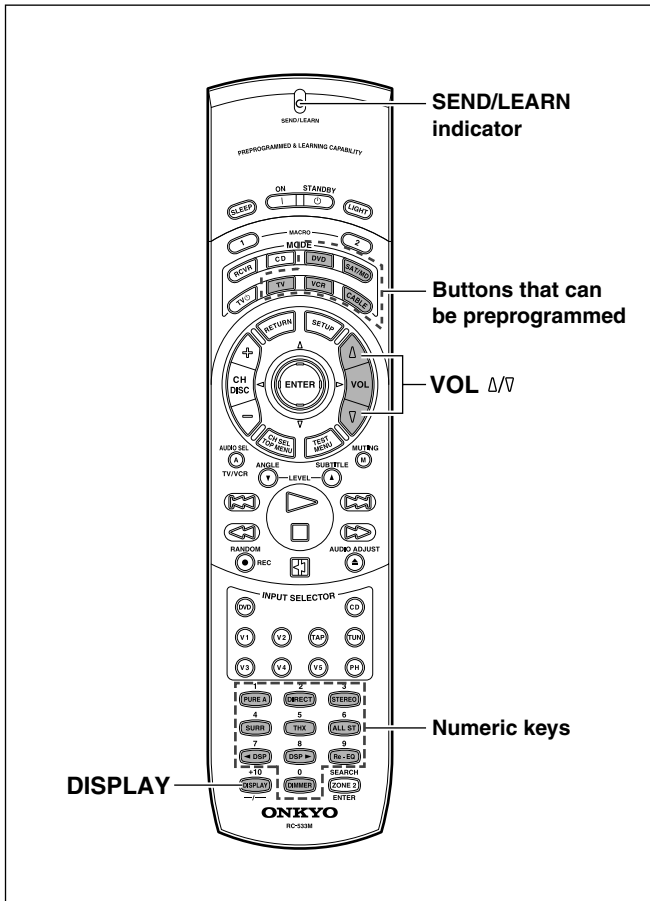

Caution

With some brand's components, some buttons may not work correctly. In this case, program the command directly from the other remote controller normally (see page 71).

Learning a pre-programming code

By entering a pre-programming code, you can have the RC-533M/515M remote controller operate a component made by another manufacturer. The buttons that are used for operation are given on the next page.

1. Find the 3-digit number listed for the manufacturer name of the component that you want to operate in the table on the next page.
2. Turn on the component that you want to operate (i.e. DVD, satellite tuner, or television).
3. While holding down the MODE button on the RC-533M/515M that you want to program, press the DISPLAY button, and then release both buttons.

The SEND/LEARN indicator lights when the MODE button is pressed and turns off when the DISPLAY button is pressed. When the indicator turns off, release both buttons. The SEND/LEARN indicator lights again.

4. Within 30 seconds, enter the 3-digit code number.

The SEND/LEARN indicator slowly flashes twice. If the SEND/LEARN indicator quickly flashes three times, then either a mistaken 3-digit code was entered or an incorrect operation was performed. If this occurs, return to step 3.

5. Press the button that you programmed and check if the system operates correctly.

- If the component does not operate properly, return to step 3 and repeat the steps above.
- If it still does not operate properly, program the command directly from the other remote controller normally (see page 71).

When entering the code of Onkyo DVD players:

There are three SETTING numbers. Choose the SETTING number according to how you will be using the DVD player.

No. 601/613: These codes are for operating the Onkyo DVD player by pointing the remote controller directly at it, either because it does not have an terminal, or it does but you are not connecting it with an cable. First enter 601 and if it does not operate properly, enter 613.

No. 600: This code is for Onkyo DVD players that have an terminal that you are connecting to the TX-SR701/701E/601/601E with an cable. You will then operate the DVD player by pointing the remote controller at the remote control sensor on the TX-SR701/701E/601/601E. You do not need to enter this code because it is factory preset. However, if the code has been changed to 601 or 613, then you will need to change it back to 600.

Entering a pre-programming code

Pre-programming codes

Note:

If more than one code is given in the table, try each code one by one until you reach the code that works (i.e. if the first code does not work, then try the next).

DVD

BRAND	SETTING No.
DENON	602, 609
HITACHI	603
JVC	604
KENWOOD	605
MAGNAVOX	606, 613
MARANTZ	607
MITSUBISHI	608, 613
ONKYO	600, 601, 613
PANASONIC	609
PIONEER	610
PROSCAN	611
RCA	611
SONY	612
TOSHIBA	613
YAMAHA	609, 614
ZENITH	613, 615

SAT

BRAND	SETTING No.
ECHOSTAR	700
GENERAL INSTRUMENTS	701
HITACHI	702
HUGHES NETWORK SYSTEMS	703
PANASONIC	704
PRIMESTAR	705
PROSCAN	706, 707
RCA	706, 707
SONY	708
TOSHIBA	709

CABLE

BRAND	SETTING No.
GENERAL INSTRUMENTS	500
GEMINI	501
HAMLIN	502, 503, 504, 505
JERROLD	500, 506, 507, 508, 509, 510, 511, 512, 513, 514
MACOM	515, 516, 517
MAGNAVOX	518
OAK	519, 520, 521
PANASONIC	522, 523
PHILIPS	524, 525, 526, 527, 528, 529
PIONEER	530, 531
SCIENTIFIC ATLANTA	532, 533, 534
SAMSUNG	535
TOCOM	536
ZENITH	537, 538

VCR

BRAND	SETTING No.
AIWA	300, 301, 302
AKAI	303, 304, 305, 306, 307
BAIRD	308
BELL & HOWELL	309
BLAUPUNKT	310
CGM	311, 312, 313
COLTINA	314
DAEWOO	315, 316
DIGITAL	317
EMERSON	318, 319, 320, 321, 322
FENNER	323
FISHER	324, 325, 326, 327
FUJITSU GENERAL	328
FUNAI	329
GE	330, 331
GO VIDEO	332, 336, 337
GOLDSTAR	333, 334
GOODMANS	335
GRUNDIG	338
HITACHI	339, 340, 341
JVC	342, 343, 344, 345, 346, 347, 348, 349, 350
LOEWE	351, 352
MAGNAVOX	353, 354, 355
MITSUBISHI	356, 357, 358, 359, 360, 361, 362, 363, 364
NEC	365, 366, 367
NOKIA	313
NORDMENDE	368, 369, 370
OKANO	371, 372
ORION	319, 373
PANASONIC	374, 375, 376, 377, 378
PHILIPS	353, 379, 380
PHONOLA	311
PIONEER	381
RCA	382
SABA	383
SAMSUNG	384, 385, 386, 387, 388, 389, 390
SANYO	391, 392, 393
SCOTT	394
SELECO	395
SHARP	396, 397, 398, 399
SHINTOM	400
SIEMENS	401
SONY	402, 403, 404, 405, 406, 407, 408, 409, 410, 411, 412, 413
SYMPHONIC	414
TEKNIKA	414, 415
TELEFUNKEN	416, 417
TOSHIBA	418, 419, 420
WHITE WESTINGHOUSE	333
WATSON	421
ZENITH	422

TV

BRAND	SETTING No.
AIWA	100, 101
AKAI	102, 103, 104
AUDIOSONIC	105
BELL & HOWELL	106
BLAUPUNKT	107
BRIONVEGA	108, 109
CENTURION	110
COLTINA	111, 112, 113
CORONAD	114
CROWN	115, 116
DAEWOO	117, 118, 119, 120, 121
DUAL	122
EMERSON	123, 124, 125, 126, 127
FENNER	128, 129
FERGUSON	130, 131
FISHER	132
FUNAI	133, 134, 135
FUJITSU GENERAL	136, 137, 138
GE	139, 140, 141
GOLDSTAR	142, 143
GOODMANS	144
GRUNDIG	145, 146
HITACHI	147, 148, 149, 150
HYPER	151
INNO HIT	152
IRRADIO	103
JVC	153, 154, 155, 156, 157
KENDO	158
KTV	159, 160
LUXOR	161
MAGNAVOX	162, 163
MARANTZ	164
MARK	165
MATSUI	166, 167, 168, 169
MITSUBISHI	170, 171, 172, 173
MIVAR	174, 175
NEC	176, 177
NOKIA	178, 179, 180, 181
OCEANIC	181
NORDMENDE	182, 183
OKANO	152
ORION	184, 185, 186
PANASONIC	187, 188, 189, 190
PHILIPS	152, 162, 191
PIONEER	192, 193
PROSCAN	194
QUASAR	195
RADIO SHACK	196
RCA	110, 141, 197, 198, 199, 200
SABA	182, 183, 201
SAMSUNG	202, 203, 204, 205, 206, 207, 208
SANYO	209, 210, 211, 212
SCHNEIDER	103
SEARS	213
SELECO	214, 215
SHARP	216, 217
SONY	218, 219, 220, 221, 222, 223
SYMPHONIC	224, 225
TELEFUNKEN	201, 226, 227
THOMSON	228
TOSHIBA	213, 229
UNIVERSUM	230
ZENITH	231, 232

Operating your programmed remote controller

After entering a pre-programming by following the procedure given above, the following modes become enabled for use.

DVD MODE (DVD Player Mode)

Operations are the same as explained on page 64.

SAT MODE (Satellite Tuner Mode)

1. Press the **SAT/MD MODE** button.

The SAT/MD MODE button lights.

2. Press the **desired operation button**.

The buttons shaded in the figure to the left are the operation buttons that can be used to control your satellite tuner unit.

The buttons given below have operations programmed into them.

ON: Turns on and off satellite tuner unit (same as **STANDBY** button on the remote controller)

CH \leftrightarrow / \leftarrow / \rightarrow : Changes selected preset channel

Δ / ∇ / \leftarrow / \rightarrow : Moves cursor

ENTER: Confirms selection

MENU: Displays menu

0,1 to 9: Numeric keys

ENTER: Confirm

You may also use the following buttons:

VOL Δ / ∇ : Adjusts the volume at the TX-SR701/701E/601/601E

MUTING: Activates the muting function at the TX-SR701/701E/601/601E

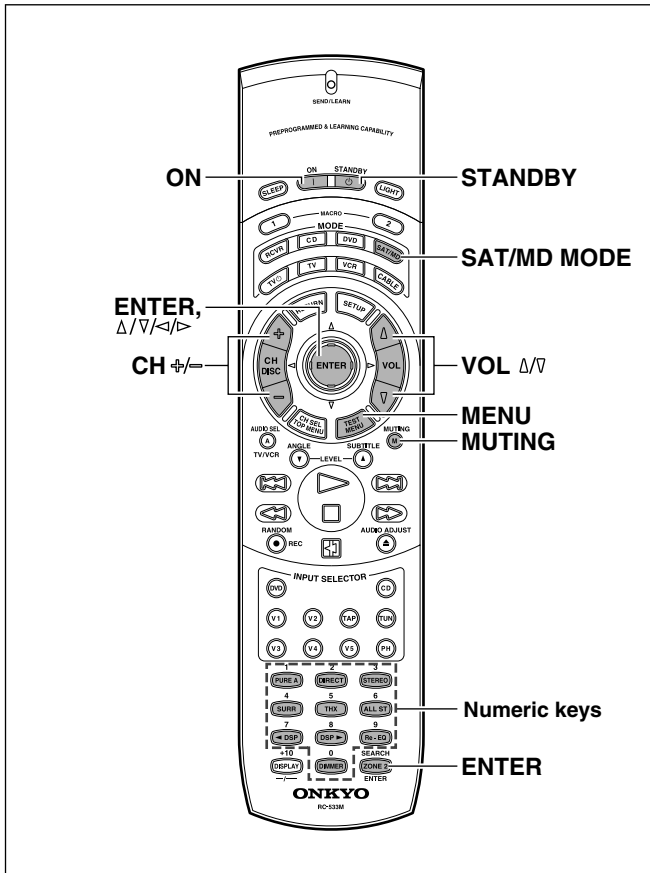

CABLE MODE (Cable Mode)

1. Press the **CABLE MODE** button.

The CABLE MODE button lights.

2. Press the **desired operation button**.

The buttons shaded in the figure to the left are the operation buttons that can be used to control your cable TV unit.

The buttons given below have operations programmed into them.

ON: Turns on and off cable TV unit (same as **STANDBY** button on the remote controller)

CH \leftrightarrow / \leftarrow / \rightarrow : Changes selected preset channel

0,1 to 9: Numeric keys

ENTER: Confirm

You may also use the following buttons:

VOL Δ / ∇ : Adjusts the volume at the TX-SR701/701E/601/601E

MUTING: Activates the muting function at the TX-SR701/701E/601/601E

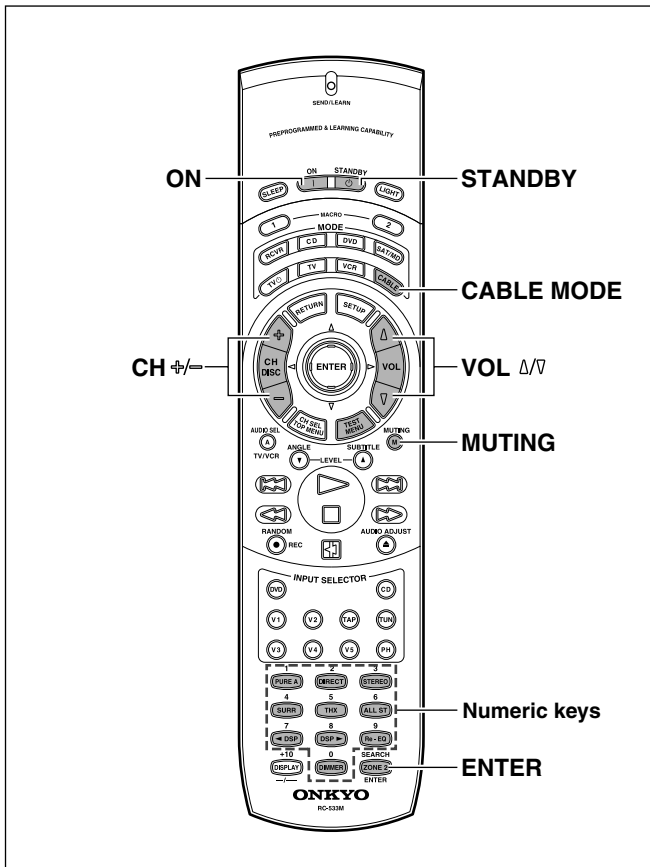

Operating your programmed remote controller

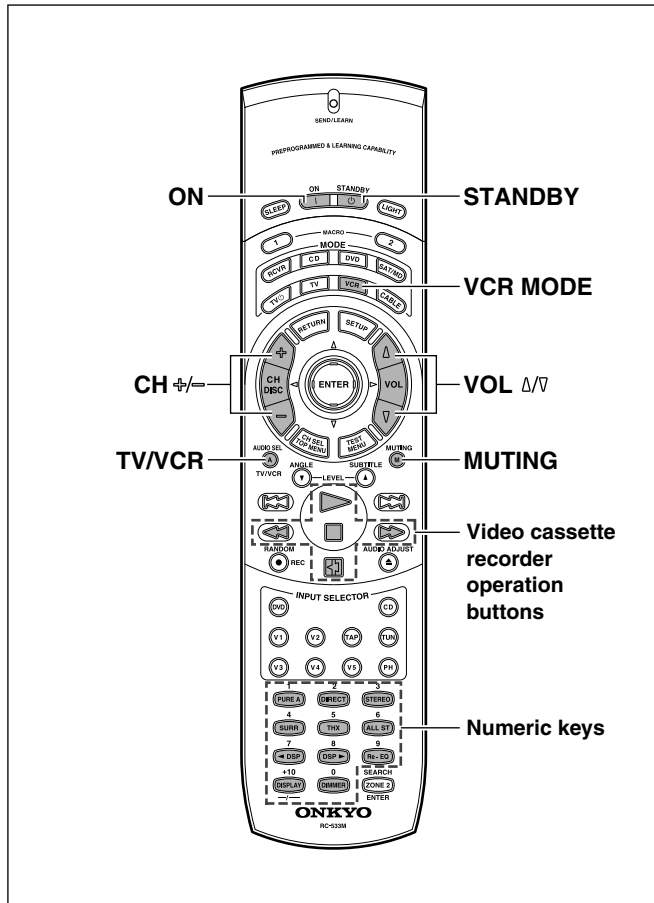

VCR MODE (VCR Mode)

1. Press the **VCR MODE** button.

The VCR MODE button lights.

2. Press the **desired operation button**.

The buttons shaded in the figure to the left are the operation buttons that can be used to control your VCR.

The buttons given below have operations programmed into them.

ON: Turns on and off the VCR (same as **STANDBY** button on the remote controller)

CH +/-: Changes selected preset channel

TV/VCR: Switches VCR input setting

▷: Play

□: Stop

◀: Rewind

▶: Fast forward

⏸: Pause

0,1 to 9, +10: Numeric keys

You may also use the following buttons:

VOL Δ/V: Adjusts the volume at the TX-SR701/701E/601/601E

MUTING: Activates the muting function at the TX-SR701/701E/601/601E

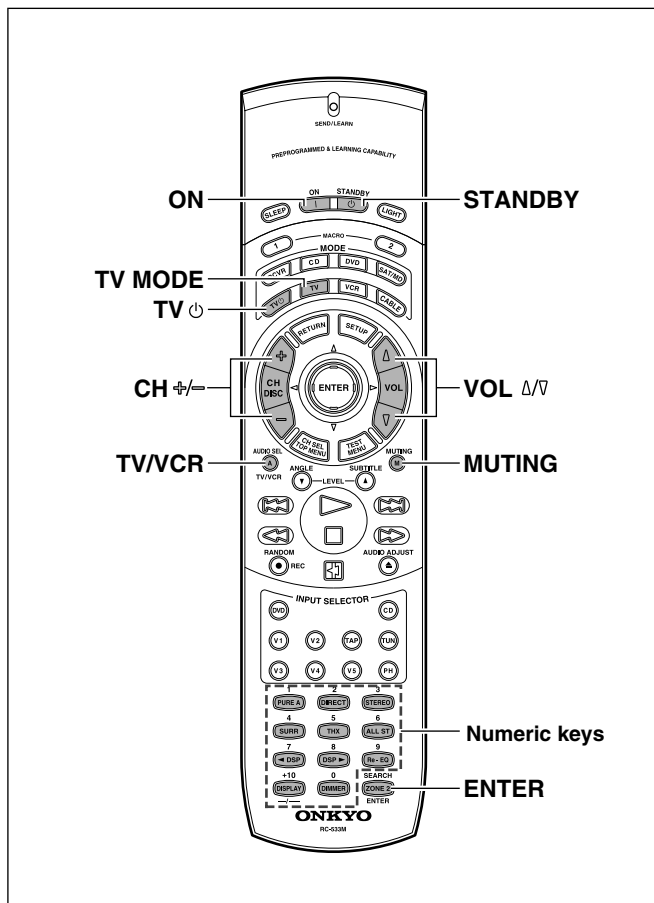

TV MODE (TV Mode)

1. Press the **TV MODE** button.

The TV MODE button lights.

2. Press the **desired operation button**.

The buttons shaded in the figure to the left are the operation buttons that can be used to control your television.

The buttons given below have operations programmed into them.

ON: Turns on and off the television (same as **STANDBY** button on the remote controller)

TV: Turns on and off the television (and switches to the TV mode)

CH +/-: Changes television channel

TV/VCR: Switches television input setting

0,1 to 9, +10: Numeric keys

ENTER: Confirm

VOL Δ/V: Adjusts volume at television

MUTING: Activates muting function at television

Programming the commands of remote controllers for other devices into the remote controller

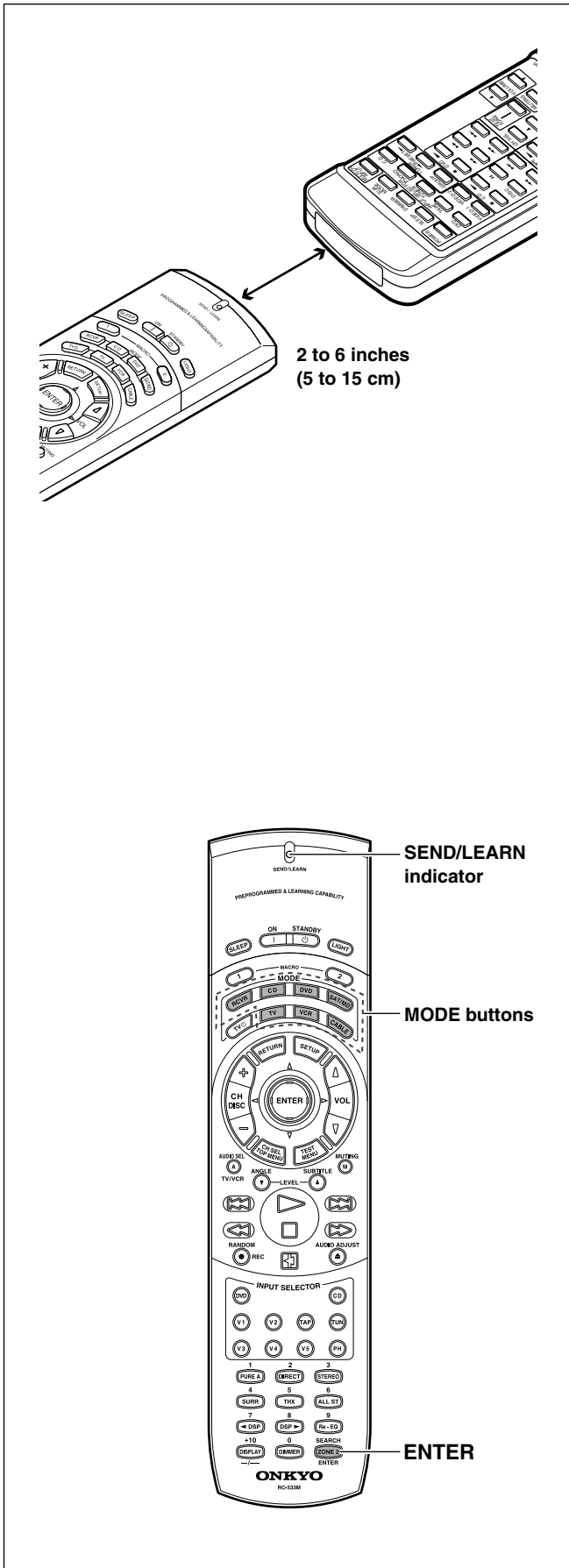

Programming procedure

When programming the commands of another remote controller to the RC-533M/515M remote controller, you must first decide under which MODE button you want the commands to be linked. In general, you will select the MODE button that corresponds to the component you are programming. For example, if you are programming the functions from a remote controller for a compact disc player, you would choose the CD MODE button. Then, by pressing the CD MODE button, the buttons on the RC-533M/515M remote controller will change to the commands you program here to operate the compact disc player.

After programming which MODE button to use, you will then transfer the separate commands from the other remote controller over to the RC-533M/515M remote controller one at a time. Each command is then programmed to a different button on the RC-533M/515M remote controller. Any button is programmable for this step except for the eight MODE buttons (RCVR, CD, DVD, SAT/MD, TV, VCR, and CABLE), the two MACRO buttons (1 and 2), and the LIGHT button (RC-533M only).

Even after the commands have been memorized, keep your old remote controller in a safe place. If for some reason the commands are lost (e.g., when the batteries run down), it will be necessary to memorize them once again.

1. Place the remote controller and the remote controller for the other device facing each other at a distance of 2 to 6 inches (5 to 15 cm) apart.

2. While pressing and holding down the desired MODE button on the remote controller, press the ENTER button and then release both buttons.

The SEND/LEARN indicator lights when the MODE button is pressed and turns off when the ENTER button is pressed. When the indicator turns off, release both buttons. The SEND/LEARN indicator lights again.

3. Press and release the button on the remote controller to which you want to transfer the next command.

You may select any button excluding the eleven ones indicated in the figure below. When you press the button, the SEND/LEARN indicator turns off. When you release the button, the indicator lights again.

If you press the wrong button by mistake, press that same button again. The SEND/LEARN indicator flashes twice, and the remote controller exits the programming mode.

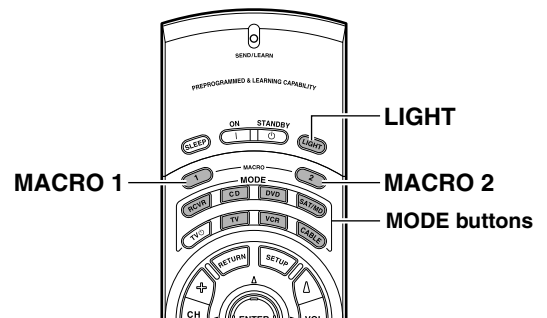

■ : Buttons that cannot be programmed

Programming the commands of remote controllers for other devices into the remote controller

4. **Press and hold down the button (that corresponds to the command you are programming) on the remote controller of the other device until the SEND/LEARN lamp on the remote controller flashes twice.**

After flashing twice, the SEND/LEARN indicator will light again.

5. **Repeat Steps 3 and 4 to transfer all the commands you desire from the other remote controller and program them to buttons on the remote controller under the same MODE.**

Repeat Steps 2 through 4 to program commands to a different MODE (e.g., when programming from a different remote controller).

6. **Press the MODE button that you pressed in step 2 to complete the programming.**
7. **Operate the newly programmed buttons to make sure the learning function was performed properly.**

Notes:

- The remote controller codes for Onkyo compact disc players, cassette tape decks, DVD players, and mini disc recorder have already been programmed into buttons on the remote controller. You may, however, use these buttons to program the codes for other remote controllers. If you wish to restore the Onkyo preset codes after you program new codes, you must first erase the new codes.
- The remote controller has 357 memory slots (7 modes × 51 buttons). Some remote controllers may have more commands that can be remembered by the remote controller. In such cases, it will be necessary for you to determine which commands are more important than others.
- If the SEND/LEARN indicator quickly flashes three times and turns off, then the remote controller has exited the programming mode because either you have made a mistake during programming or a time-out has occurred because no button has been pressed. Resume from Step 2.
- If you try to program beyond the learning capacity of the remote controller, the SEND/LEARN indicator flashes six times quickly, and the remote controller exits the programming mode. Try programming under a different MODE button.
- When you want to program a command to a button to which you have already programmed a command, simply follow the same procedure given and the previous programming for that button will be overwritten.
- The remote controller uses infrared rays to send its commands, as do most other remote controllers. Though most remote controller codes can be memorized by the remote controller, be aware that some remote controllers use systems that are quite different from the remote controller and therefore may not be able to be programmed.
- Some remote controllers have a single button that performs multiple functions (for example, the function may change each time the button is pressed). If this is the case, each function must be programmed to a separate button on the remote controller.
- Once you have transferred the commands from the other remote controller, refer to the instruction manual that came with that product for instructions on how to operate that product.
- Make sure both the remote controller and the other remote controller have new batteries. If either of them has batteries that are low, you may not be able to program the commands of the other remote controller properly into the remote controller.

See page 72 for how to erase the memorized commands from all buttons.

Erasing the programmed command from one button

You can only erase memorized commands and not preset ones.

1. **Press and hold down the MODE button for the command, press the ENTER button, and then release both buttons.**

When you press the MODE button, the SEND/LEARN indicator lights. When you press the ENTER button, the lamp turns off. When you release the buttons, the lamp lights again.

2. **Press and release the button for the command you wish to erase.**

When you press the button, the SEND/LEARN indicator turns off. When you release the button, the lamp lights again.

3. **Press and release the same button again.**

The SEND/LEARN lamp slowly flashes twice. The memorized command is erased.

Note:

If the SEND/LEARN indicator quickly flashes three times and turns off, then the remote controller has exited the erasing mode because either you have made a mistake during erasing or a time-out has occurred because no button has been pressed. Resume from Step 1.

Erasing all the commands programmed under a MODE button

1. **Press and hold down the desired MODE button, press the ENTER button twice, and then release both buttons.**

When you press the MODE button, the SEND/LEARN indicator lights. When you press the ENTER button, the lamp turns off. When you release the buttons, the lamp slowly flashes twice and then lights again.

2. **Press and release the same MODE button again.**

When you release the button, the SEND/LEARN indicator slowly flashes twice. This erases all the commands memorized to the MODE button.

Notes:

- If the SEND/LEARN indicator quickly flashes three times and turns off, then the remote controller has exited the erasing mode because either you have made a mistake during erasing or a time-out has occurred because no button has been pressed. Resume from Step 1.
- If many commands have been programmed to the MODE button, then the SEND/LEARN indicator may remain lit for up to 20 seconds during Step 2. This is not a malfunction.

Using the macro function

What is the macro function?

A macro function enables you to program a series of button operations (up to 16) on the remote controller into a single button. The series of operations are then called a macro. For example, to play a compact disc player connected to the TX-SR701/701E/601/601E normally, you must perform the following steps:

1. Press the RCVR MODE button.
2. Press the ON button.
3. Press the CD (INPUT SELECTOR) button.
4. Press the CD MODE button.
5. Press the playback (▷) button.

By using the macro function, you can perform the above five operations by **only pressing one button**.

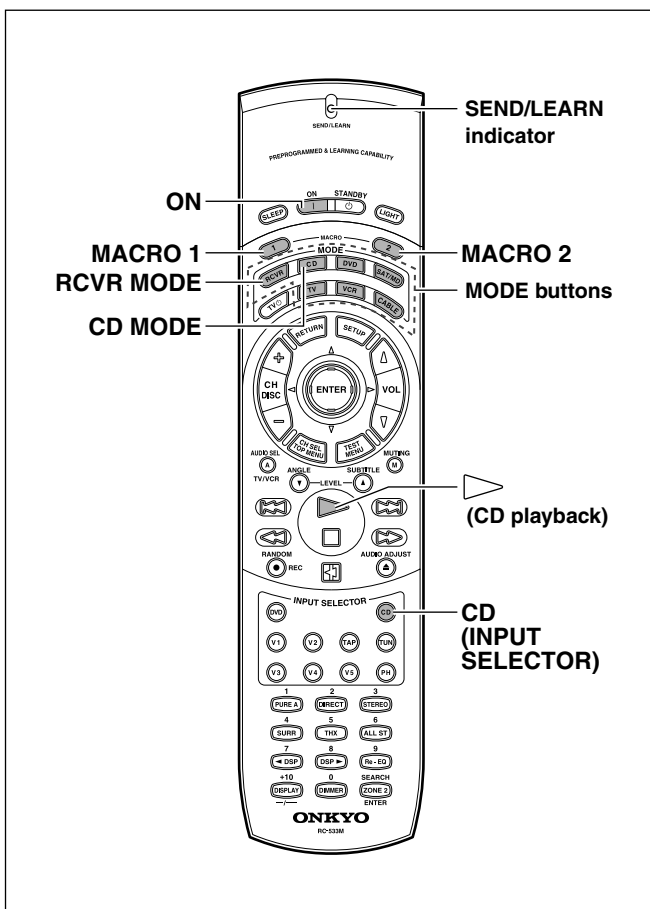

Tips:

- If you erase or change the command of a button programmed in the macro, that operation of that button will no longer work in the macro. In this case, it will be necessary for you to reprogram the macro in order to avoid incorrect operation.
- The codes programmed into the macro will be transmitted at an interval of 0.5 seconds. However, some devices may not be able to complete one operation in 0.5 seconds and may miss the next code. In this case, after pressing one operation button, you can press the same MODE button again before pressing the next operation button to add another 0.5 seconds between the two operations.

Programming the macro

With the macro function, you can program a series of button operations as a macro into the MACRO button so the macro can be executed with just one touch. Note that for the macro function, only one macro can be programmed. For example, to program the macro described above on this page for the MACRO button, perform the steps given below.

1. Press and hold down any one of the seven MODE buttons, press the MACRO 1 (or 2) button, and then release both buttons.

When you press the MODE button, it lights and the SEND/LEARN indicator lights. When you press the MACRO 1 (or 2) button, the indicator turns off. When you release the buttons, the indicator flashes briefly and then lights again.

2. Press the operation buttons you wish to program in order (in this case, press RCVR MODE → ON → CD (INPUT SELECTOR) → CD MODE → playback (▷) button).

When you press each button, the SEND/LEARN indicator turns off. When you release the button, the indicator lights.

3. Press the MACRO 1 (or 2) button to complete the procedure.

The SEND/LEARN indicator slowly flashes twice.

4. Check to see if the macro has been properly programmed.

Notes:

- You may program up to 16 button operations into the macro function. If you try to program a 17th operation, it will be ignored, and programming is stopped.
- If the SEND/LEARN indicator quickly flashes three times and turns off, then the remote controller has exited the programming mode because either you have made a mistake during programming or a time-out has occurred because no button has been pressed. Resume from Step 1.

Executing the macro

Perform the procedure below to execute the macro that you have programmed into the remote controller. After programming the macro, you should always run it at least once to make sure that it has been programmed properly.

Point the remote controller at the TX-SR701/701E/601/601E and press the MACRO 1 (or 2) button.

It may take a while for the macro to finish transmitting, so be sure to continue pointing the remote controller at the device until the SEND/LEARN indicator turns off.

Using the macro function

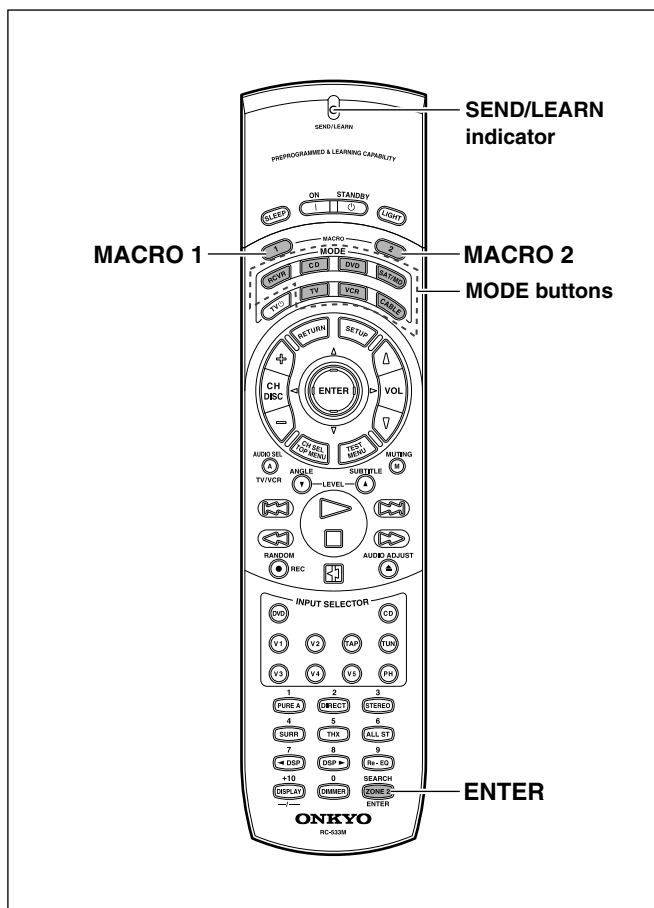

Erasing a macro from the MACRO 1 (or 2) button

1. Press and hold down any one of the seven **MODE** buttons, press the **MACRO 1** (or 2) button, and then release both buttons.

When you press the **MODE** button, it lights and the **SEND/LEARN** indicator lights. When you press the **MACRO 1** (or 2) button, the indicator turns off. When you release the buttons, the indicator flashes once.

2. Press the **MACRO 1** (or 2) button again.

The **SEND/LEARN** indicator slowly flashes twice. The macro programmed to the **MACRO** button is erased.

Notes:

- If the **SEND/LEARN** indicator quickly flashes three times and turns off, then the remote controller has exited the erasing mode because either you have made a mistake during erasing or a time-out has occurred because no button has been pressed. Resume from Step 1.
- If you press a button other than **MACRO 1** (or 2) button in Step 2, then you will in effect be overwriting the previous macro with a new macro.

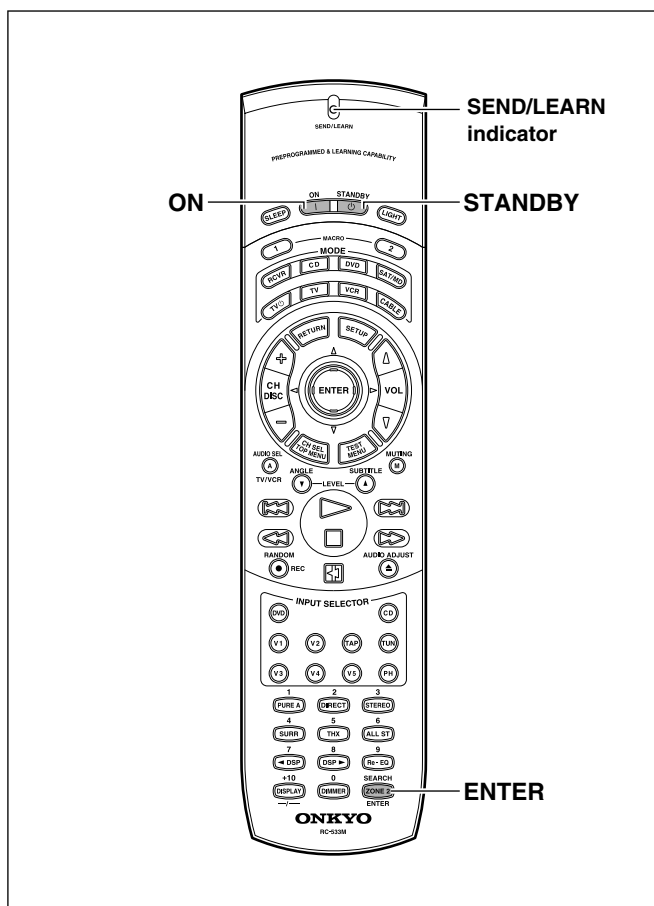

Erasing all commands and macros that have been programmed

This procedure will erase all the commands and macros that you have programmed into the remote controller and return it to its default settings. This operation will not affect the preset settings of the remote controller.

1. Open the battery cover and remove the batteries from the remote controller.
2. While pressing and holding down the **ON** and **STANDBY** buttons, re-insert the batteries in their correct orientation, and then release both buttons.

The **SEND/LEARN** indicator flashes slowly.

3. Press the **ENTER** button.

The **SEND/LEARN** indicator lights up for about ten seconds and then turns off.

All programmed commands and macros are erased and the remote controller returns to its factory presets.

Notes:

- Proceed to Step 3 immediately after Step 2; otherwise, the batteries will be consumed quickly.
- If you press any button other than the **ENTER** button in Step 3, nothing will be erased. In this case, resume from Step 1.

Troubleshooting guide

If a problem occurs while you are using the remote controller, first try to operate the controls on the front panel of the TX-SR701/701E/601/601E to make sure that it is not due to a malfunction (or worn out batteries) in the remote controller.

POWER

No power.

- Power cord is disconnected.
→ Connect the power cord (see page 28).
- External noise is affecting the internal microcomputer.
→ Turn off the power, wait five seconds, and then turn back on the power.
- Internal fuse is blown.
→ Contact your Onkyo Service Center.

Power turns on but no sound.

- “Muting” is displayed.
→ Press the MUTING button on the remote controller to turn off muting (see page 45).
- Bad connections or wiring.
→ Check connections, speaker cables, and other wiring (see pages 16-27).
- Amplifier protection circuitry is activated.
→ Contact your Onkyo Service Center.

Sound of playback source is not heard.

- Input selector is not set properly.
→ Set to correct input source.
- Headphones are connected.
→ Lower volume and then disconnect headphones.

Power shuts off immediately after power on.

- Amplifier protection circuitry is activated.
→ Remove the power cord from the outlet immediately. Contact your Onkyo service center.

SPEAKERS

No sound from the center speaker, or at very low volume.

- Speaker cable is not connected.
→ Check the connection between amplifier and speaker (see page 27).
- Listening mode is set to Stereo, Pure Audio (TX-SR701/701E only), or Direct.
→ Set the Listening mode to any mode other than Stereo or Direct. The output to the center speaker may differ depending on the listening mode.
- Center speaker volume is set to minimum.
→ Set the center speaker level to the appropriate volume (see page 34).
- The Center setting is set to “None.”
→ Set the Center setting to “Large” or “Small” at “Speaker Config” (see page 31).

No sound or very low volume from subwoofer.

- Subwoofer setting is set to “No.”
→ Set the Subwoofer setting to “Yes” at “Speaker Config” (see page 32).
- Subwoofer volume is set to minimum.
→ Set the subwoofer level to the appropriate volume (see page 34).

Low frequency humming is heard.

- Turntable motor is not properly grounded. (TX-SR701/701E only)
→ Check for proper ground connection.
- Audio connection cables on the rear panel are connected incorrectly.
→ Adjust the placement of the cable to reduce hum.

Howling is heard when the volume is turned up. (TX-SR701/701E only)

- Turntable and speakers are located too close together.
→ Move them farther apart.

Rough or scratchy sound is heard. High range is not clear.

- Turntable needle is dirty or worn (TX-SR701/701E only), or a problem exists with a connected component.
→ Refer to the instruction of the connected components and check for problem.
- Treble control is too high.
→ Turn treble setting down at Audio Adjust → Treble (see page 57).

FM/AM TUNER

AM stations cannot be received.

- AM loop antenna is not connected.
→ Connect the included AM loop antenna to the AM antenna terminals (see page 29).

Buzzing noise on AM stations (particularly noticeable at night or with weak stations).

- Noise from electrical apparatus such as fluorescent lamp.
→ Move the AM loop antenna to different position.
→ Set up an outdoor AM antenna (see page 30).

Noise is heard at high-pitched sounds on AM stations.

- Noise caused by TV set.
→ Place the AM loop antenna as far as possible from the TV.
→ Move TX-SR701/701E/601/601E away from TV set.

Crackling noise on both AM and FM stations.

- Noise caused by fluorescent lamp being turned on and off.
→ Move antenna as far as possible from the fluorescent lamp.
- Noise from automobile ignition.
→ Install an FM outdoor antenna as far as possible from the road (see page 30).
→ Change the position or direction of the outdoor antenna.

Troubleshooting guide

Stereo indicator lights, but sound is distorted and stereo separation is bad.

- Station is too strong.
→ Change to FM indoor antenna (see page 29).
- Multiple reflection of the radio waves because of tall buildings or mountains.
→ Use antenna that has better directivity and orient it so distortion is least.

Indicators for stereo reception flicker and hiss is heard on FM stations.

- Station is too weak.
→ Install an outdoor FM antenna (see page 30).
- Stereo FM broadcasts cover only about half the distance of an ordinary broadcast.
→ Change the position or direction of the outdoor antenna (see page 30).

No preset station is recalled.

- Memory is lost because power has been turned off for a long time.
→ Store all stations again (see page 38).

VIDEO and AUDIO

Desired picture does not appear.

- Improper connection.
→ Check connections. Insert the plugs and connectors completely (see pages 14 to 30).

No OSD Menu display.

- Improper connection.
→ Check connections (see pages 14 to 30).
- OSD Menu is displayed when monitor is connected to VIDEO or S VIDEO of MONITOR OUT.
→ Check connections (see page 20).

Audio and video do not match.

- Improper connection.
→ Check connections (see pages 14 to 30).

Audio is not heard or audio from different source is heard.

- Digital Input settings are incorrect.
→ Check settings at "Input Setup" → "Digital Input" (see page 52).

No picture appears on the TV screen (or monitor).

- TV (or monitor) is not set to receive the output signals from the receiver.
→ Set the TV (or monitor) to the receiver output.
- Video cable is not connected securely.
→ Check connections (see pages 14 to 30).
- Input source is connected to the COMPONENT VIDEO IN connectors.
→ Make sure TV (or monitor) is connected to COMPONENT VIDEO OUT connectors (see page 20).

REMOTE CONTROLLER

Front panel controls function but remote controller controls do not.

- No batteries in remote controller.
→ Insert batteries (see page 7).
- Batteries have worn out.
→ Replace batteries (see page 7).
- Remote controller is not pointed at the remote sensor of the TX-SR701/701E/601/601E.
→ Point the remote controller at the remote sensor of the TX-SR701/701E/601/601E (see page 7).
- Remote controller is too far from the TX-SR701/701E/601/601E.
→ Operate the remote controller within 16 feet (5 meters) (see page 7).
- Remote controller is functioning in a different mode
→ Press the RCVR MODE button.

OTHER

LATE NIGHT function cannot be used.

- Playback source is not Dolby Digital encoded.
→ Check that the DOLBY DIGITAL indicator lights up on the display.

Desired parameter cannot be set.

- Parameter may not be able to be set due to current listening mode.
→ Check settings in Audio Adjust (see pages 57 to 59).

Multichannel audio is not output.

- DVD player is not connected to 5.1-channel input jacks.
→ Check connections (see page 17).

Components in remote zone (Zone 2) do not operate properly.

- Components are incorrectly connected.
→ Check connections.
- Objects are interfering with remote controller signals.
→ Move interfering objects away from path of remote controller signals.

Sound is sometimes heard and sometimes not heard with digital sources.

- One digital input format has been specified so other digital formats are not played.
→ Use the AUDIO SELECTOR to select "Auto" and set "Auto" for the Auto mode (see page 42).

Noise during playback or skipping of the beginning sounds occurs with DTS sources, PCM sources, and other digital sources.

- When "Auto" is set for the digital format setting, time is required to change formats when different sources are played.
→ Switch from the Auto mode to the current source signal (see page 42).

Troubleshooting guide

If one of the messages shown below appears

“Not available with headphones use”

Operation not allowed because headphones are plugged into the TX-SR701/701E/601/601E.

“Not available with Multichannel use”

Operation not allowed while the multi-channel output is being used.

“Not available in this Sp Config”

Will not work with the current speaker configuration settings.

“Not available in Zone 2 mode”

Setting not allowed because the Zone 2 mode is turned on.

“Only available with Dolby D”

No setting other than Dolby Digital can be set.

“Not available in this Listening mode”

Will not work with the current listening mode.

“Not available with this signal”

The listening mode cannot be selected with the current input source.

“Not available with Muting”

Operation not allowed because the muting is activated.

“Zone 2 is not On”

Will not work because the Zone 2 has not been turned on.

Also refer to the respective instruction manuals of the CD player, DVD player, video cassette recorder, TV monitor, etc., that compose your entertainment system.

The TX-SR701/701E/601/601E contains an internal microcomputer that performs high-level operations. However, on extremely rare occasions, noise or interference from an external source or static electricity may cause faulty operation. If this occurs, unplug the power cord from the wall outlet, wait five or more seconds, and then plug it back in. This should correct the situation.

- * To reset the surround mode and other settings to the factory default settings, hold down the VIDEO 1 button with the TX-SR701/701E/601/601E turned on and then press the STANDBY/ON button. “CLEAR” appears in the front display and the TX-SR701/701E/601/601E enters the standby state.

Specifications (TX-SR701/701E)

AMPLIFIER SECTION

Continuous average power output (FTC)

All channels: **100 W per channel min. RMS at 8 Ω , 2 channels driven from 20 Hz to 20 kHz with no more than 0.08% total harmonic distortion.**
125 W min. RMS at 6 Ω , 2 channels driven from 1 kHz with no more than 0.1% total harmonic distortion.

Continuous power output (DIN)

Maximum power output (EIAJ)

Dynamic power output (stereo)

Total harmonic distortion:

IM distortion:

Damping factor:

Input sensitivity and impedance

PHONO:

LINE (CD, TAPE, DVD,

VIDEO 1-4):

MULTICHANNEL INPUT

(FRONT L/C/R, SURROUND

L/R):

(SUBWOOFER):

COAXIAL (DIGITAL):

DVD, VIDEO 1, 2, 3, 4:

COMPONENT VIDEO 1, 2:

Output level and impedance

Rec out (TAPE, VIDEO 1, 2):

Line out:

Pre out:

VIDEO (VIDEO 1, 2,

MONITOR OUT):

COMPONENT VIDEO OUT:

Phono overload:

Frequency response:

RIAA deviation:

Tone control

Bass:

Treble:

Signal-to-noise ratio (stereo)

Phono:

Line:

Muting:

130 W at 6 Ω

160 W at 6 Ω

2 \times 230 W at 3 Ω

2 \times 170 W at 4 Ω

2 \times 115 W at 8 Ω

0.08% at rated power

0.08% at 1 W output

0.08% at rated power

0.08% at 1 W output

60 at 8 Ω

2.5 mV, 47 k Ω

200 mV, 47 k Ω

200 mV, 47 k Ω

36 mV, 47 k Ω

0.5 V_{p-p}, 75 Ω

1 V_{p-p}, 75 Ω

1 V_{p-p}, 75 Ω (Y)

0.28 V_{p-p}, 75 Ω (C)

1 V_{p-p}, 75 Ω (Y)

0.7 V_{p-p}, 75 Ω (PB, PR)

200 mV, 470 Ω

100 mV, 470 Ω (Zone 2)

1 V, 470 Ω

1 V_{p-p}, 75 Ω

1 V_{p-p}, 75 Ω (Y)

0.28 p-p, 75 Ω (C)

1 V_{p-p}, 75 Ω (Y)

0.7 V_{p-p}, 75 Ω (PB, PR)

70 mV RMS at 1 kHz, 0.5% T.H.D.

10 Hz to 100 kHz: +1/-3 dB

(CD in Direct mode)

20 Hz to 20 kHz: \pm 0.8 dB

\pm 10 dB at 50 Hz

\pm 10 dB at 20,000 Hz

80 dB (IHF A, 5 mV input, Direct mode)

106 dB (IHF A, 0.5 V input, Direct mode)

-50 dB

TUNER SECTION

FM

Tuning range:

USA & Canadian models:

87.50-108.00 MHz (100-kHz steps)

Other area models:

87.50-108.00 MHz (50-kHz steps)

Usable sensitivity

Mono:

11.2 dBf, 1.0 μ V (75 Ω IHF)

0.9 μ V (75 Ω DIN)

Stereo:

17.2 dBf, 2.0 μ V (75 Ω IHF)

23 μ V (75 Ω DIN)

50 dB quieting sensitivity

Mono:

17.2 dBf, 2.0 μ V (75 Ω)

Stereo:

37.2 dBf, 20 μ V (75 Ω)

Capture ratio:

2.0 dB

Image rejection ratio

USA & Canadian models:

40 dB

Other area models:

85 dB

IF rejection ratio:

90 dB

Signal-to-noise ratio

Mono:

76 dB

Stereo:

70 dB

Alternate channel attenuation:

55 dB

Selectivity:

50 dB (DIN)

AM suppression ratio:

50 dB

Total harmonic distortion

Mono:

0.2%

Stereo:

0.3%

Frequency response:

30 Hz-15 kHz, \pm 1.0 dB

Stereo separation:

45 dB at 1 kHz

30 dB at 100 Hz-10 kHz

AM

Tuning range

USA & Canadian models:

530 to 1,710 kHz (10-kHz steps)

European & Australian models:

522 to 1,611 kHz (9-kHz steps)

Worldwide models:

522 to 1,611 kHz (9-kHz steps)

530 to 1,710 kHz (10-kHz steps)

Usable sensitivity:

30 μ V

Image rejection ratio:

40 dB

IF rejection ratio:

40 dB

Signal-to-noise ratio:

40 dB

Total harmonic distortion:

0.7%

GENERAL

Power supply

USA & Canadian models:

AC 120 V, 60 Hz

European & Australian models:

AC 230-240 V, 50 Hz

Some Asian models:

AC 220-230 V, 50/60 Hz

Worldwide models:

AC 220-230 and 120 V switchable,

50/60 Hz

Power consumption

USA & Canadian models:

6.0 A

Other models:

620 W

Dimensions (W \times H \times D):

435 \times 175 \times 431.5 mm

17-1/8" \times 6-7/8" \times 16-15/16"

Weight

USA & Canadian models:

26.9 lbs.

Other models:

13.0 kg

REMOTE CONTROLLER

Transmitter:

Infrared

Signal range:

Approx. 16 ft., 5 meters

Power supply:

Two "AA" batteries (1.5 V \times 2)

Specifications and features are subject to change without notice.

Specifications (TX-SR601/601E)

AMPLIFIER SECTION

Continuous average power output (FTC)

All channels: 85 W per channel min. RMS at 8 Ω , 2 channels driven from 20 Hz to 20 kHz with no more than 0.08% total harmonic distortion. 110 W min. RMS at 6 Ω , 2 channels driven from 1 kHz with no more than 0.1% total harmonic distortion.

Continuous power output (DIN)

120 W at 6 Ω

Maximum power output (EIAJ)

150 W at 6 Ω

Dynamic power output (stereo)

2 \times 220 W at 3 Ω

2 \times 165 W at 4 Ω

2 \times 100 W at 8 Ω

Total harmonic distortion:

0.08% at rated power

0.08% at 1 W output

IM distortion:

0.08% at rated power

0.08% at 1 W output

60 at 8 Ω

Damping factor:

Input sensitivity and impedance

LINE (CD, TAPE, DVD,

VIDEO 1-4):

200 mV, 47 k Ω

MULTICHANNEL INPUT (FRONT L/C/R, SURROUND L/R):

200 mV, 47 k Ω

(SUBWOOFER):

36 mV, 47 k Ω

COAXIAL (DIGITAL):

0.5 Vp-p, 75 Ω

DVD, VIDEO 1, 2, 3, 4:

1 Vp-p, 75 Ω

1 Vp-p, 75 Ω (Y)

0.28 Vp-p, 75 Ω (C)

1 Vp-p, 75 Ω (Y)

0.7 Vp-p, 75 Ω (PB, PR)

COMPONENT VIDEO 1, 2:

Output level and impedance

Rec out (TAPE, VIDEO 1, 2):

200 mV, 470 Ω

Line out:

100 mV, 470 Ω (Zone 2)

Pre out:

1 V, 470 Ω

VIDEO (VIDEO 1, 2,

MONITOR OUT):

1 Vp-p, 75 Ω

1 Vp-p, 75 Ω (Y)

0.28 Vp-p, 75 Ω (C)

COMPONENT VIDEO OUT:

1 Vp-p, 75 Ω (Y)

0.7 Vp-p, 75 Ω (PB, PR)

10 Hz to 100 kHz: +1/-3 dB

(CD in Direct mode)

Frequency response:

Tone control

Bass:

± 10 dB at 50 Hz

Treble:

± 10 dB at 20,000 Hz

Signal-to-noise ratio (stereo)

CD/Tape:

106 dB (IHF A, 0.5 V input)

Muting:

-50 dB

TUNER SECTION

FM

Tuning range:

USA & Canadian models:

87.50–108.00 MHz (100-kHz steps)

Other area models:

87.50–108.00 MHz (50-kHz steps)

Usable sensitivity

Mono:

11.2 dBf, 1.0 μ V (75 Ω IHF)

0.9 μ V (75 Ω DIN)

Stereo:

17.2 dBf, 2.0 μ V (75 Ω IHF)

23 μ V (75 Ω DIN)

50 dB quieting sensitivity

Mono:

17.2 dBf, 2.0 μ V (75 Ω)

Stereo:

37.2 dBf, 20 μ V (75 Ω)

Capture ratio:

2.0 dB

Image rejection ratio

USA & Canadian models:

40 dB

Other area models:

85 dB

IF rejection ratio:

90 dB

Signal-to-noise ratio

Mono:

76 dB

Stereo:

70 dB

Alternate channel attenuation:

55 dB

Selectivity:

50 dB (DIN)

AM suppression ratio:

50 dB

Total harmonic distortion

Mono:

0.2%

Stereo:

0.3%

Frequency response:

30 Hz–15 kHz, ± 1.0 dB

Stereo separation:

45 dB at 1 kHz

30 dB at 100 Hz–10 kHz

AM

Tuning range

USA & Canadian models:

530 to 1,710 kHz (10-kHz steps)

European & Australian models:

522 to 1,611 kHz (9-kHz steps)

Worldwide models:

530 to 1,710 kHz (10-kHz steps)

Usable sensitivity:

30 μ V

Image rejection ratio:

40 dB

IF rejection ratio:

40 dB

Signal-to-noise ratio:

40 dB

Total harmonic distortion:

0.7%

GENERAL

Power supply

USA & Canadian models:

AC 120 V, 60 Hz

European & Australian models:

AC 230–240 V, 50 Hz

Some Asian models:

AC 220–230 V, 50/60 Hz

Worldwide models:

AC 220–230 and 120 V switchable, 50/60 Hz

Power consumption

USA & Canadian models:

5.3 A

Other models:

550 W

Dimensions (W \times H \times D):

435 \times 175 \times 431.5 mm

17-1/8" \times 6-7/8" \times 16-15/16"

Weight

USA & Canadian models:

26.7 lbs.

Other models:

12.9 kg

REMOTE CONTROLLER

Transmitter:

Infrared

Signal range:

Approx. 16 ft., 5 meters

Power supply:

Two "AA" batteries (1.5 V \times 2)

Specifications and features are subject to change without notice.

ONKYO CORPORATION

Sales & Product Planning Div. : 2-1, Nisshin-cho, Neyagawa-shi, OSAKA 572-8540, JAPAN
Tel: 072-831-8111 Fax: 072-831-8124

ONKYO U.S.A. CORPORATION

18 Park Way, Upper Saddle River, N.J. 07458, U.S.A.
Tel: 201-785-2600 Fax: 201-785-2650 <http://www.onkyousa.com>

ONKYO EUROPE ELECTRONICS GmbH

Liegnitzerstrasse 6, 82194 Groebenzell, GERMANY
Tel: +49-8142-4401-0 Fax: +49-8142-4401-555 <http://www.onkyo.net>

ONKYO CHINA LIMITED

Units 2102-2107, Metroplaza Tower I, 223 Hing Fong Road, Kwai Chung,
N.T., HONG KONG Tel: 852-2429-3118 Fax: 852-2428-9039

