

Electrical Machines 2

Q # 1)

write Introduction, advantages disadvantages and Construction of Three Phase Induction Motor?

Introduction:-

An induction motor is an AC electric motor in which the electric current in the rotor needed to produce torque is obtained by electromagnetic induction from the magnetic field of stator windings.

Induction motors are also known as asynchronous motors because its rotor rotates at a speed less than the synchronous speed.

The three phase induction motor is the most widely used electrical motor. Almost 80% of the mechanical power used by industries is provided by three phase induction

motors.

Advantages:-

- i) The working of an induction motor is very simple. It can operate in any environmental condition. The construction of an induction motor
- ii) Induction motors are cheaper in cost due to the absence of brushes commutators and slip rings.
- iii) It is highly efficient motor. The efficiency of induction motor is varying from 85 to 95%.
- iv) 3-Phase induction motor is the self starting motor so any special starting arrangement is not required.
- v) The speed variation from no-load to rated load is very less.

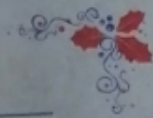

Disadvantages:-

- i) The Power factor of the motor is very low during the light load condition.
- ii) The motor cannot be used in such applications where high starting torque is necessary like traction and lifting weight.
- iii) It is essentially a constant speed motor and its speed cannot be changed easily.

Construction:-

Like any other electrical motor induction motor also have two main parts namely i) Stator and ii) Rotor. The rotor is separated from the stator by a small air-gap which ranges from 0.4mm to 4mm, depending on the Power of motor.

The main body

- of the induction motor Comprises of:
- 1- Shaft for transmitting the torque to the load. This shaft is made up of steel.
 - 2- Bearings for supporting the rotating shaft.
 - 3- Terminal box for receiving external electrical connection,
 - 4- fan is needed for cooling.

⇒ Stator:-

Stator is a stationary part of induction motor. A stator winding is placed in the stator of induction motor and three phase supply is given to it.

Stator is made up of numbers of stamping in which different slots are cut to receive 3-Phase winding circuit which are connected to 3-Phase A.C Supply.

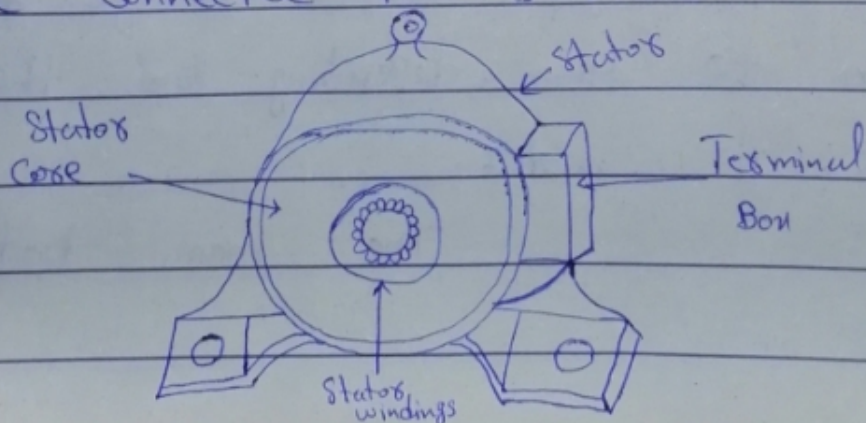

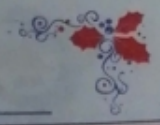

The windings are wound for a definite number of Poles depending upon the speed requirement as speed is inversely proportional to the number of Poles.

$$N_s = 120f/P$$

where

N_s = Synchronous Speed

f = frequency

P = No. of Poles

Greater the no. of Poles, lesser is the speed of the motor and vice versa.

2) Rotor:-

The rotor is rotating part of induction motor. The rotor is connected to the mechanical load through the shaft. Rotor consists of cylindrical laminated core with parallel slots, that carry conductor bars. An induction motor's rotor can be either squirrel-cage type or wound type.

2) Squirrel Cage Rotor:-

Squirrel Cage rotor is cylindrical in shape and have slots on its periphery. The slots are not made parallel to each other but are bit skewed as the skewing prevents magnetic locking of stator and rotor teeth and makes the working of motor more smooth and quieter. The Squirrel Cage rotor consists of aluminium, brass or copper bars conductors.

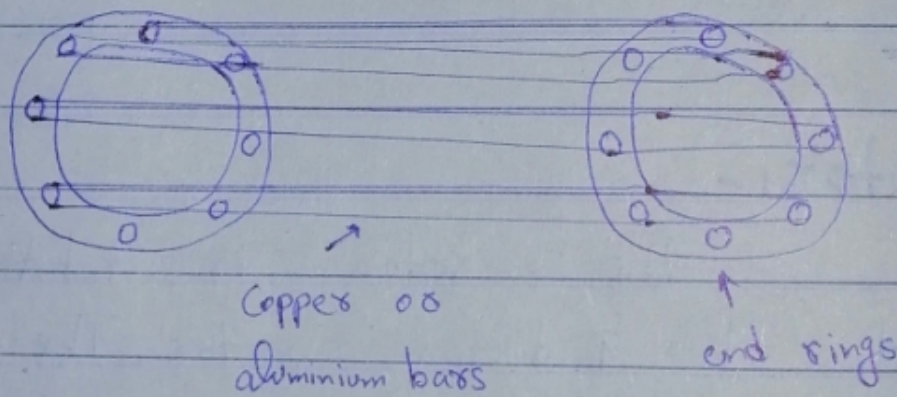

Advantages:-

- i) Its construction is very simple and rugged.
- ii) As there are no brushes and slip rings these motors require less maintenance.

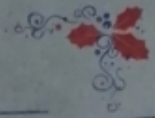

Application:-

Squirrel Cage Induction motor is used in lathes, drilling machines, fan, blowers, Pointing machines etc.

Wound Rotor:-

In this type of three phase induction motor the rotor is wound for the same no. of poles as that of stator but it has less number of slots and has less turns per phase of a heavier conductor. The rotor windings are placed in slots and three end terminals are connected together to form star connection. Slip rings are connected on same shaft as that of rotor.

The three ends of phase windings are permanently connected to these slip rings.

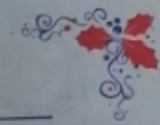

Advantages:-

- 1- It has high starting torque and low starting current.
- 2- Possibility of adding additional resistance to control speed.

Application:-

Slip ring induction motors are used where high starting torque is required i.e. in hoist, cranes, elevators.

Q. No. 2)

write Operation Principle of three Phase Induction motor.

The working principle of a three phase induction motor is "Faraday's Law of electromagnetic induction."

The stator of the motor consist of overlapping windings offset by an electrical angle of 120° . when we connect the primary windings to a stator

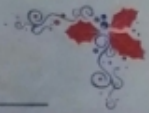

to a 3- ϕ AC source, it establishes rotating magnetic field which rotates at the Synchronous Speed.

This changing magnetic field cuts the rotor conductors and induces a current in them according to the Principle of electromagnetic induction. The rotor conductors rotations can be explained by Lenz's Law,

which tells that the induced currents in the rotor oppose the cause for its production here this opposition is rotating magnetic field. This results the rotor starts rotating in the same direction of the stator magnetic fields.

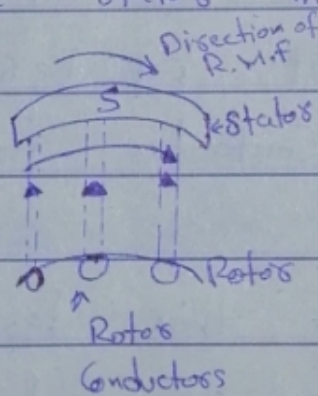



Q.No.3)

Discuss different types of starters for three Phase Induction motor.

i) Direct on-Line Starter (DOL):-

A DOL starter or across the line starter is a method of starting of a 3-Phase induction motor. In DOL starter an induction motor is connected directly across its 3- ϕ supply and the DOL applies the full line voltage to the motor terminal.

A DOL motor starter contains protection devices such as circuit breakers, overload relay and contactors for protecting motor.

Although this starter doesn't reduce the starting voltage it provide protection to the motor against overloading single phasing and low voltage.

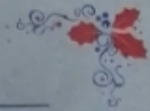

when a normally closed switch is pressed the coil becomes de-energized and the Contactors get separated by Spring arrangement these by the supply to the motor is removed.

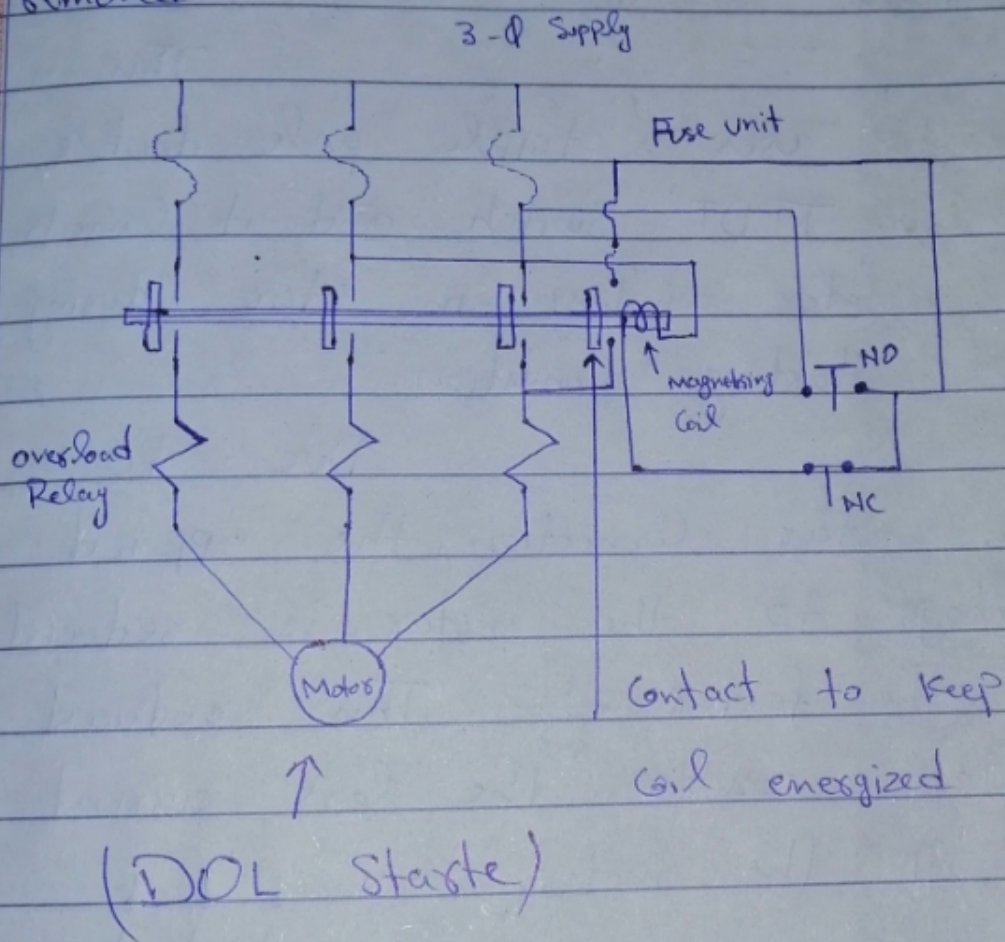

ii) Star - Delta Starter:-

A Star - Delta starter is the most commonly used method for the starting of a 3-Phase induction motor.

In Star - Delta Starting



an induction motor is connected in through a star connection throughout the starting period, then once the motor reaches the required speed, the motor is connected in through a delta connection.

This starter uses a triple pole double throw TPDT switch and it connects the stator winding in star during the starting condition.

Due to this star connection, the applied voltage to the motor is reduced by the factor $\frac{1}{\sqrt{3}}$. This reduced voltage results in less current through the motor.

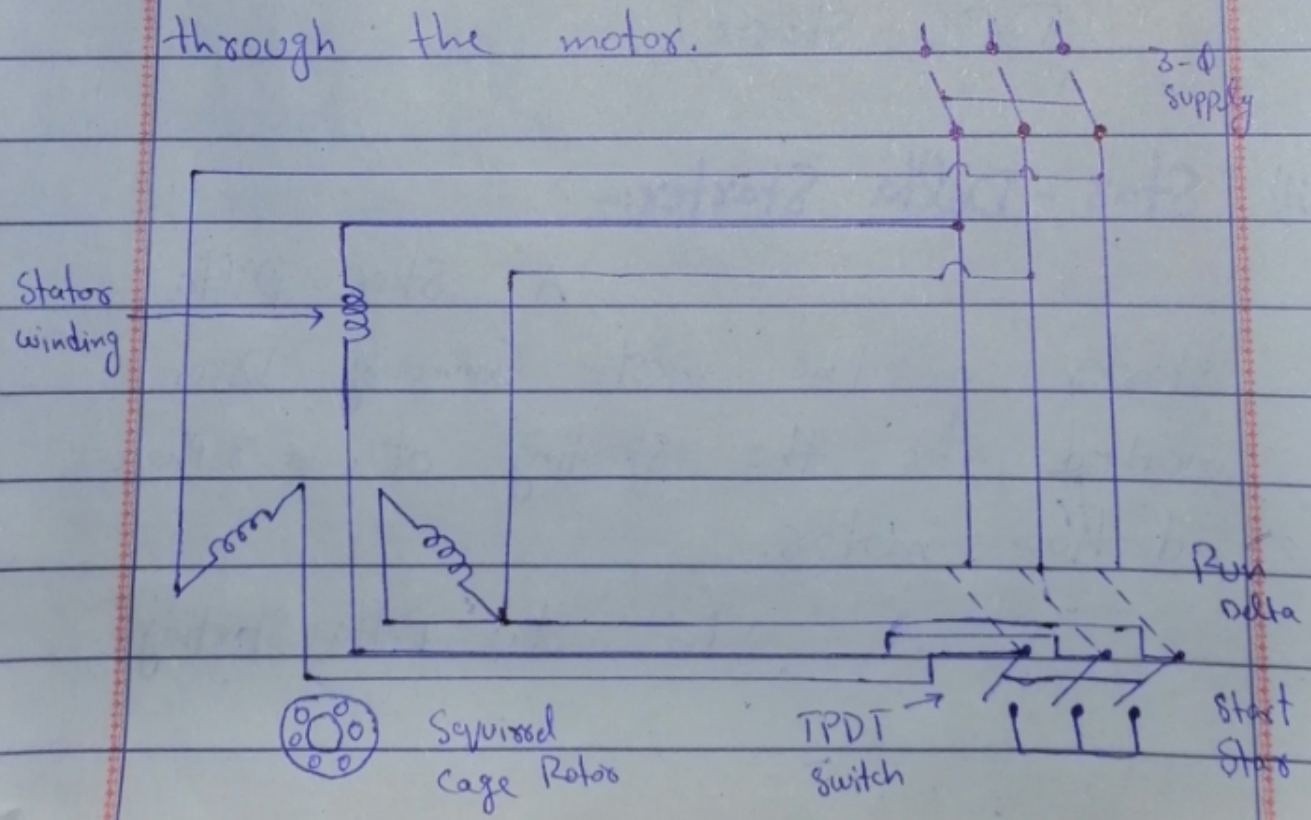

iii) Auto transformer Starter:-

In this method a 3- ϕ auto transformer is connected in series with the motor. This transformer reduces the voltage applied to the motor and hence the current.

The starter consist of changeover switch that switches the motor between reduced voltage and full voltage condition.

when this switch is in the start position, voltage is reduced. This voltage depends on the fractional percentage of tappings and is controlled by changing position of autotransformer slides.

when the motor attains 80% of its rated speed, the changeover switch is connected to run position automatically using relays. Due to this, a rated voltage is than applied to motor.

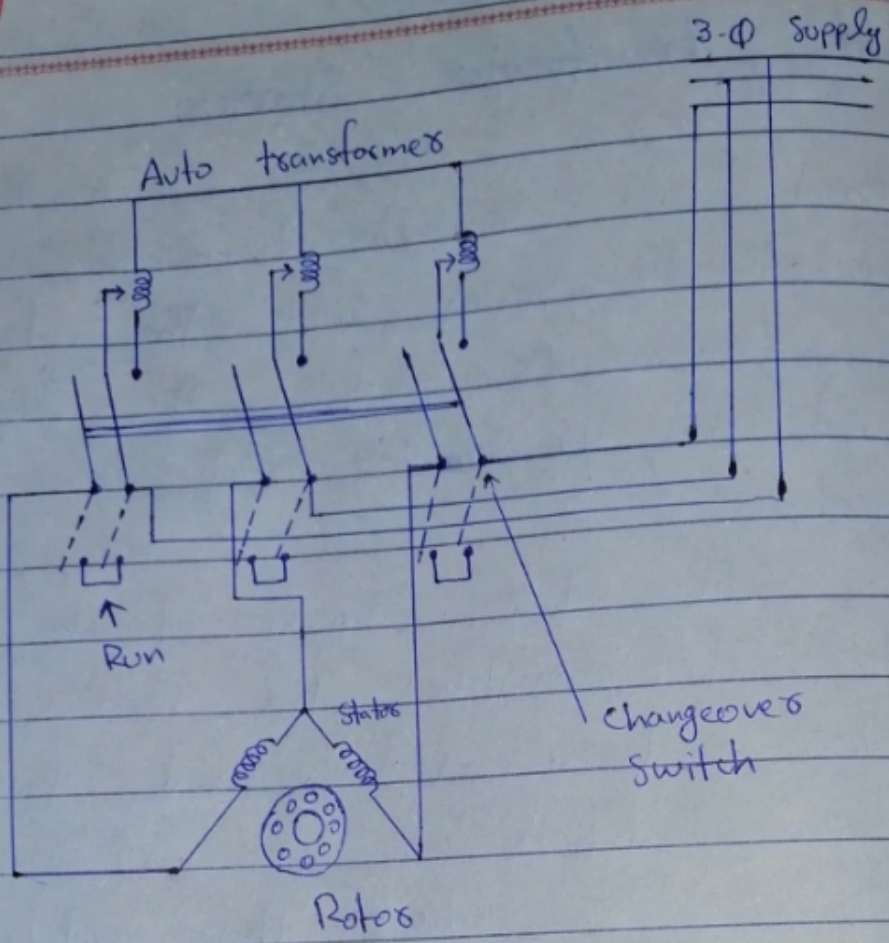

iv) Rotor Impedance Starters:-

The easiest method of starting wound rotor induction is to connect extra resistance in the rotor circuit.

Connection

of extra resistance in the rotor circuit decreases and at the same time increase the starting torque. As the motor starts rotating the extra resistance is gradually cut.

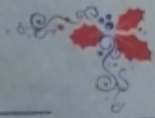

When the motor attains rated speed the resistance is fully cut out and the slip ring terminals are short circuited.

