

# CAP-21

Para motores .40/.46 2T .48/.56 4T

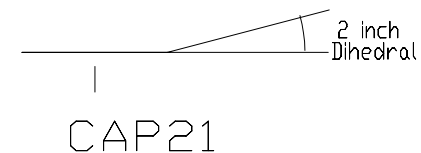
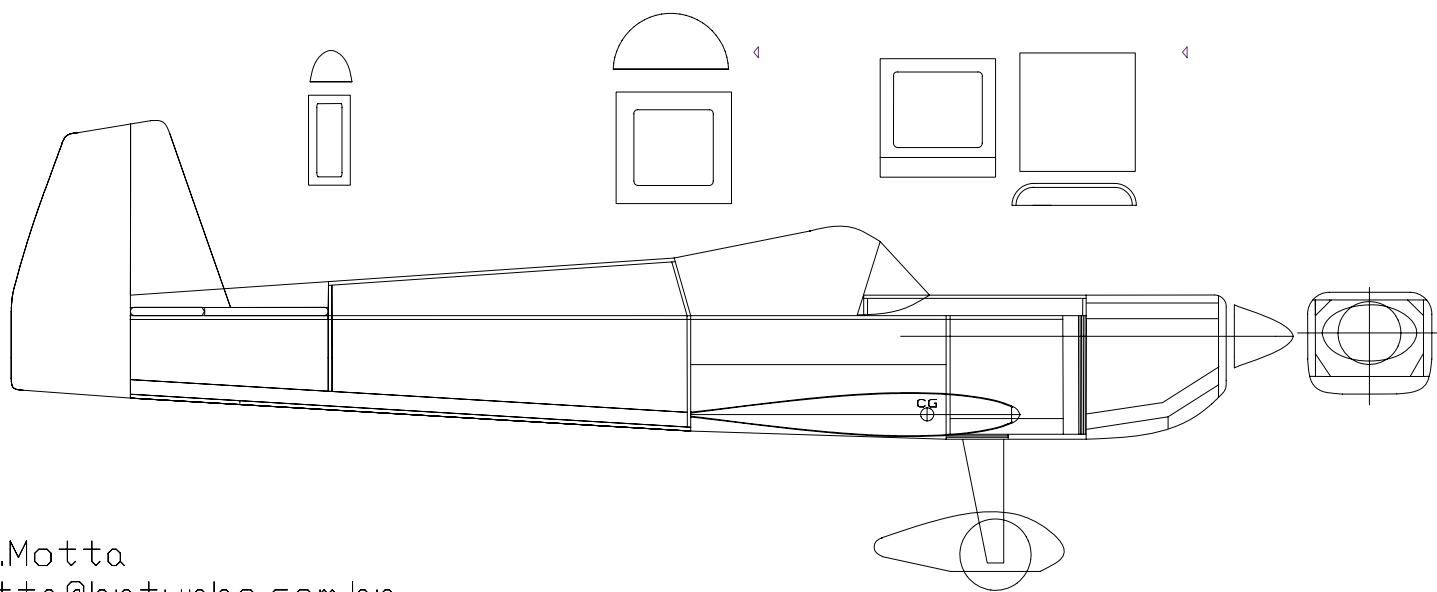
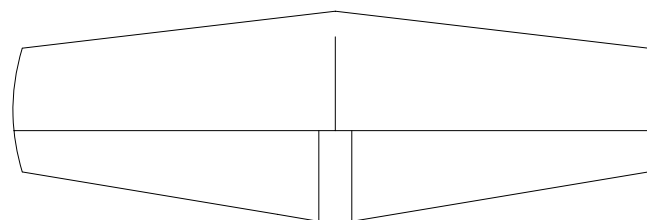
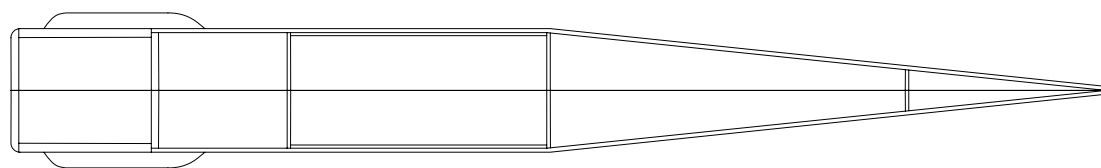
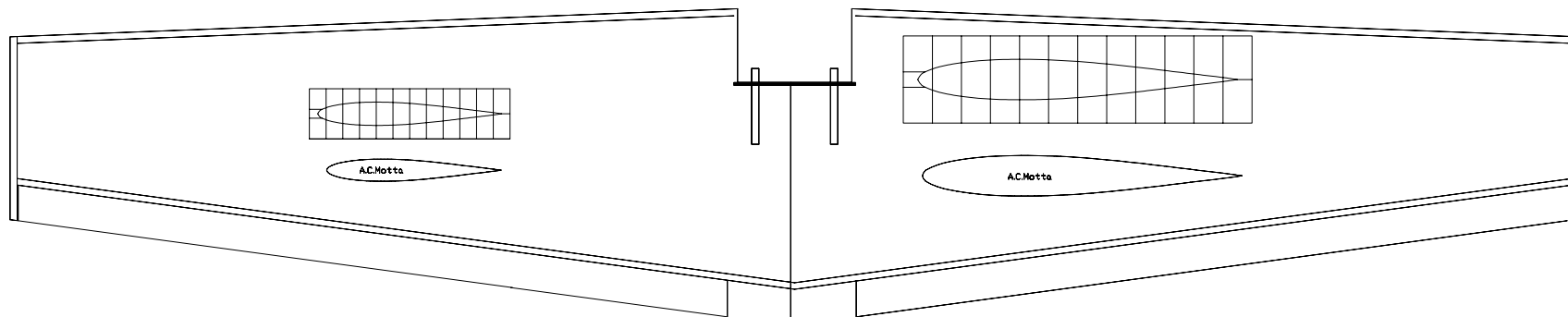

A.C.Motta  
motta@brturbo.com.br

Designed by Carl Layden  
Envergadura 1400mm  
Trabalho de escala  
e impressão  
A.C.Motta

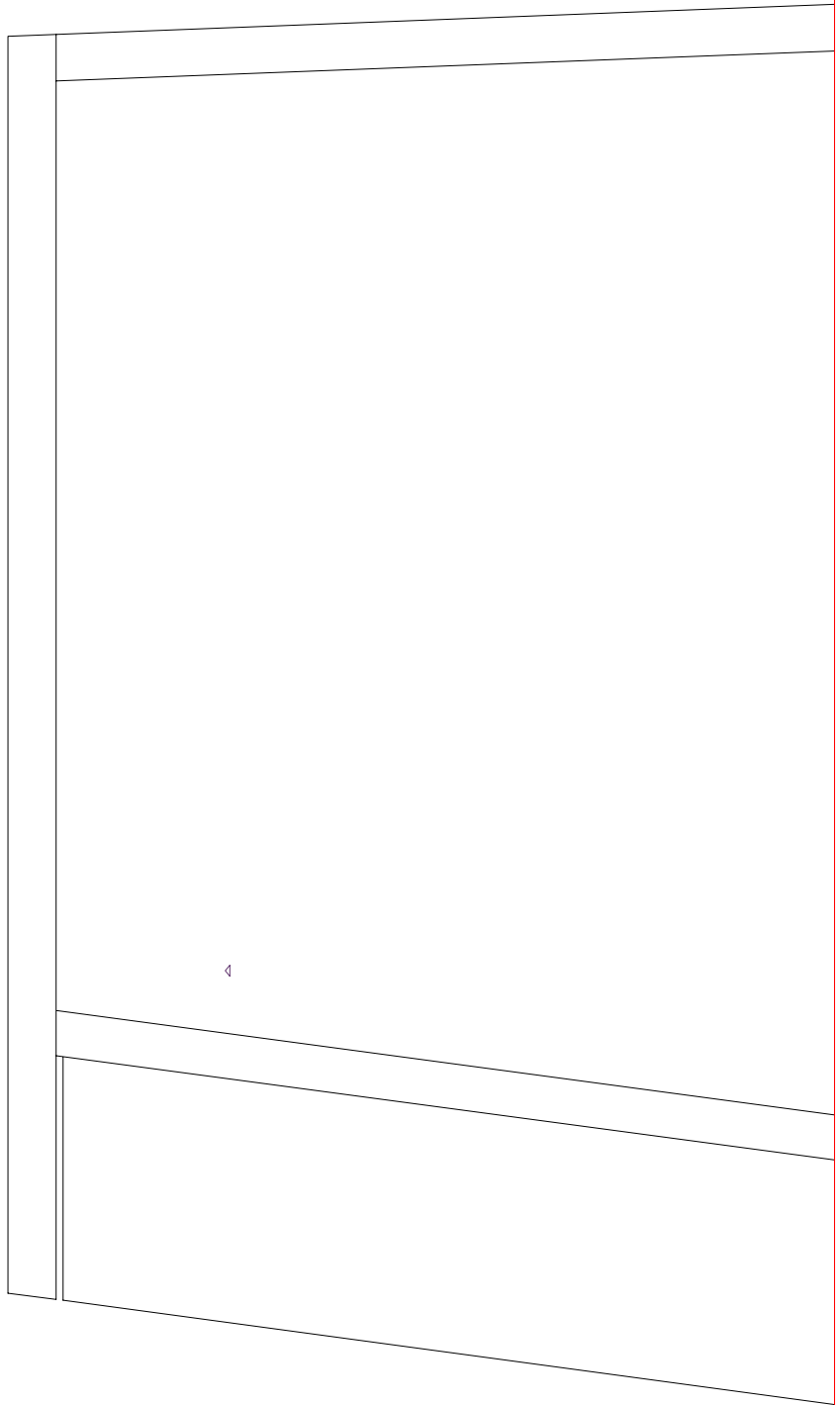

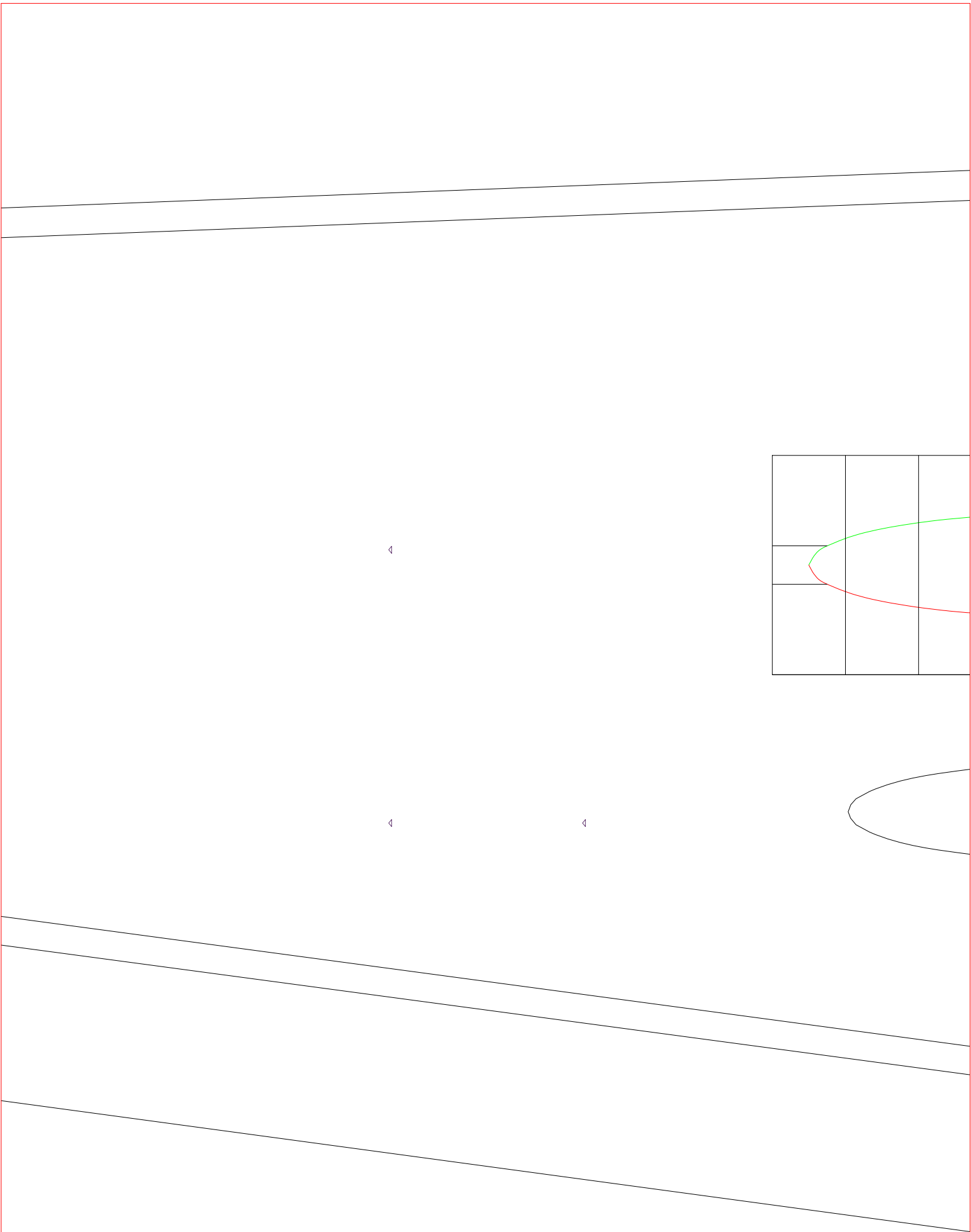



d

d

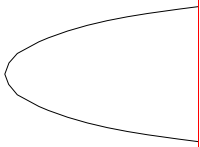
d

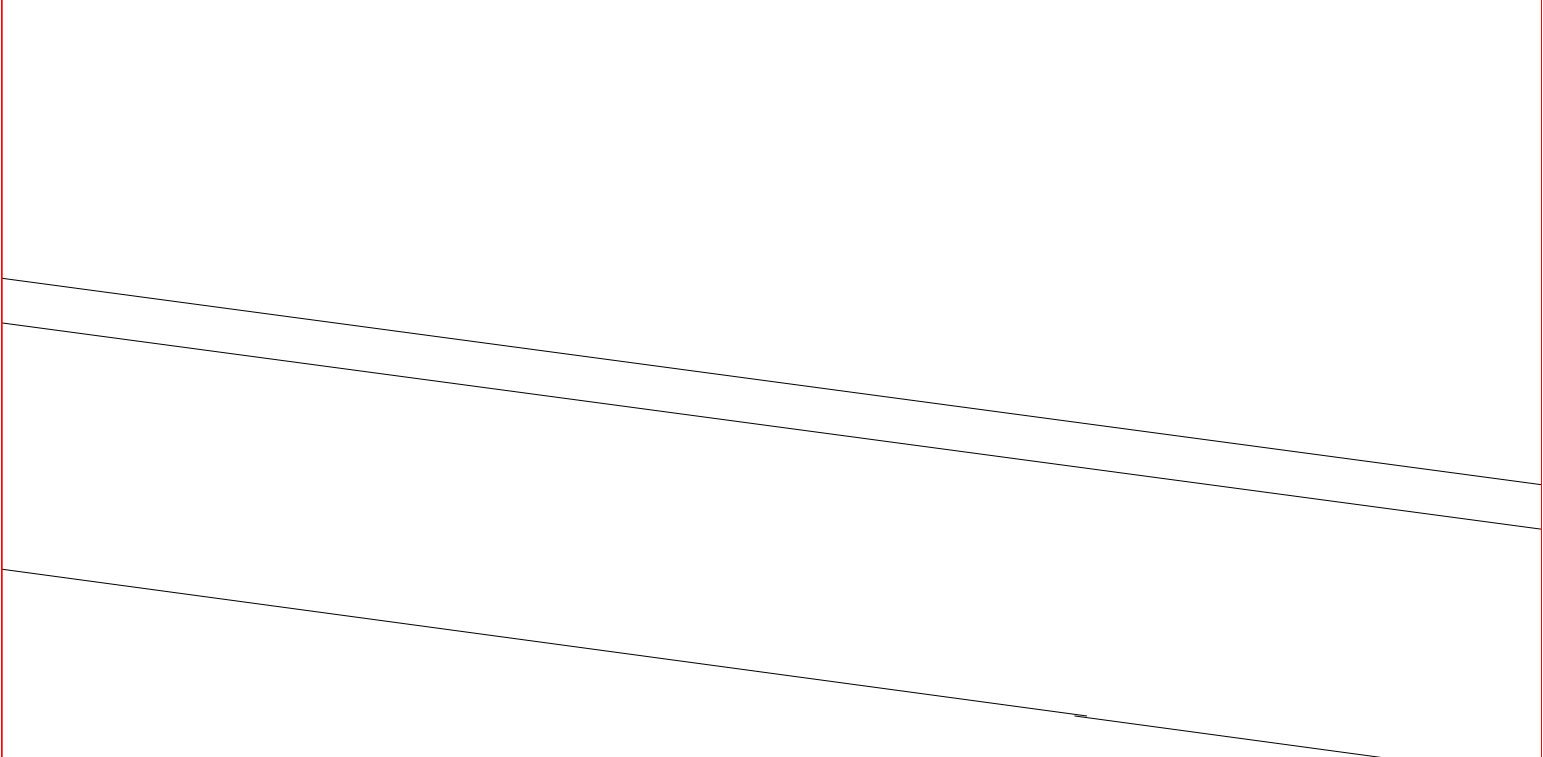
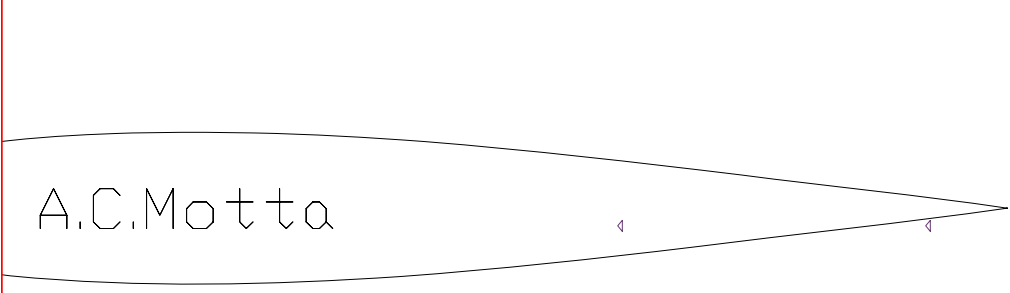
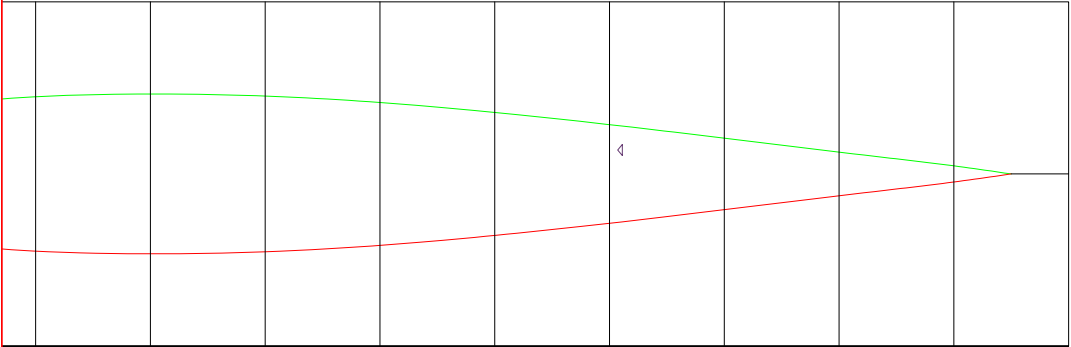
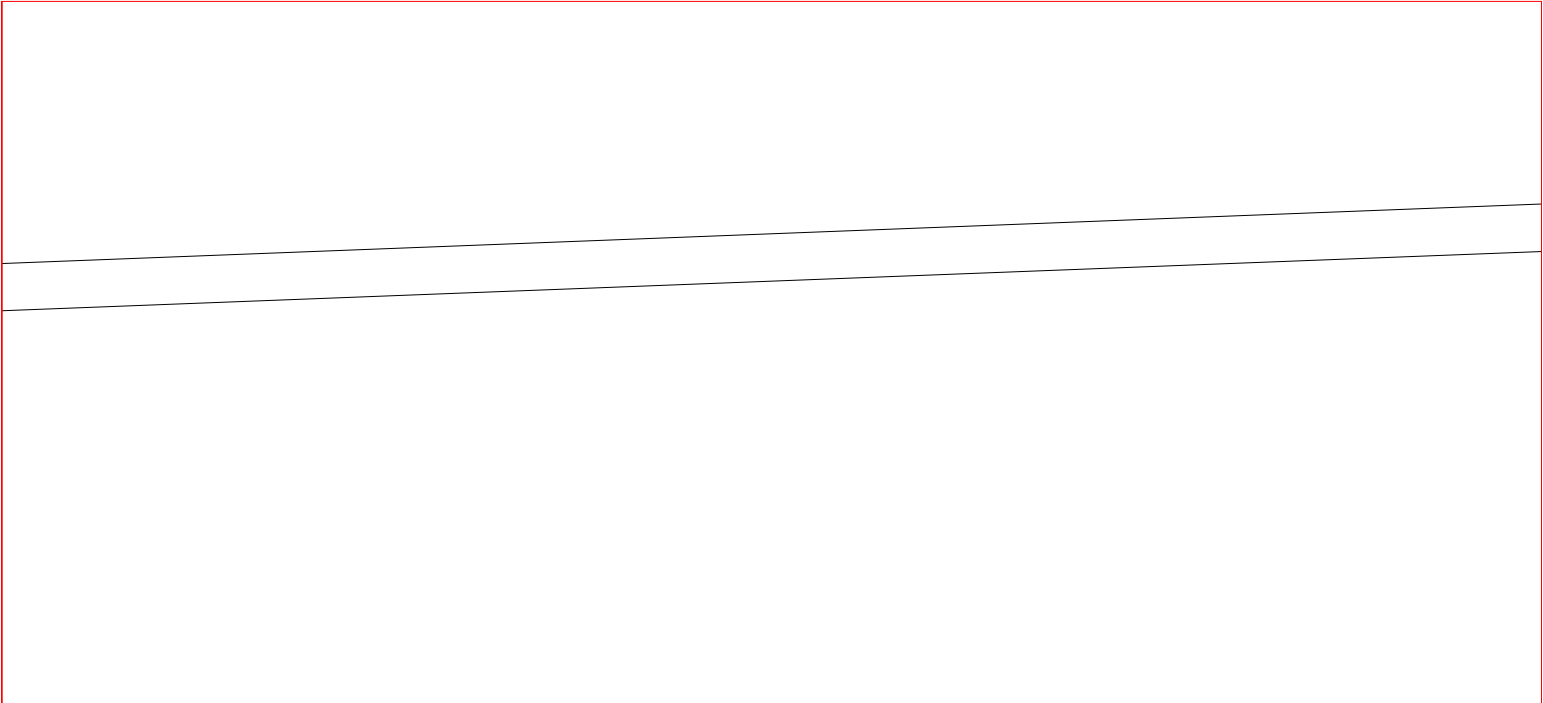

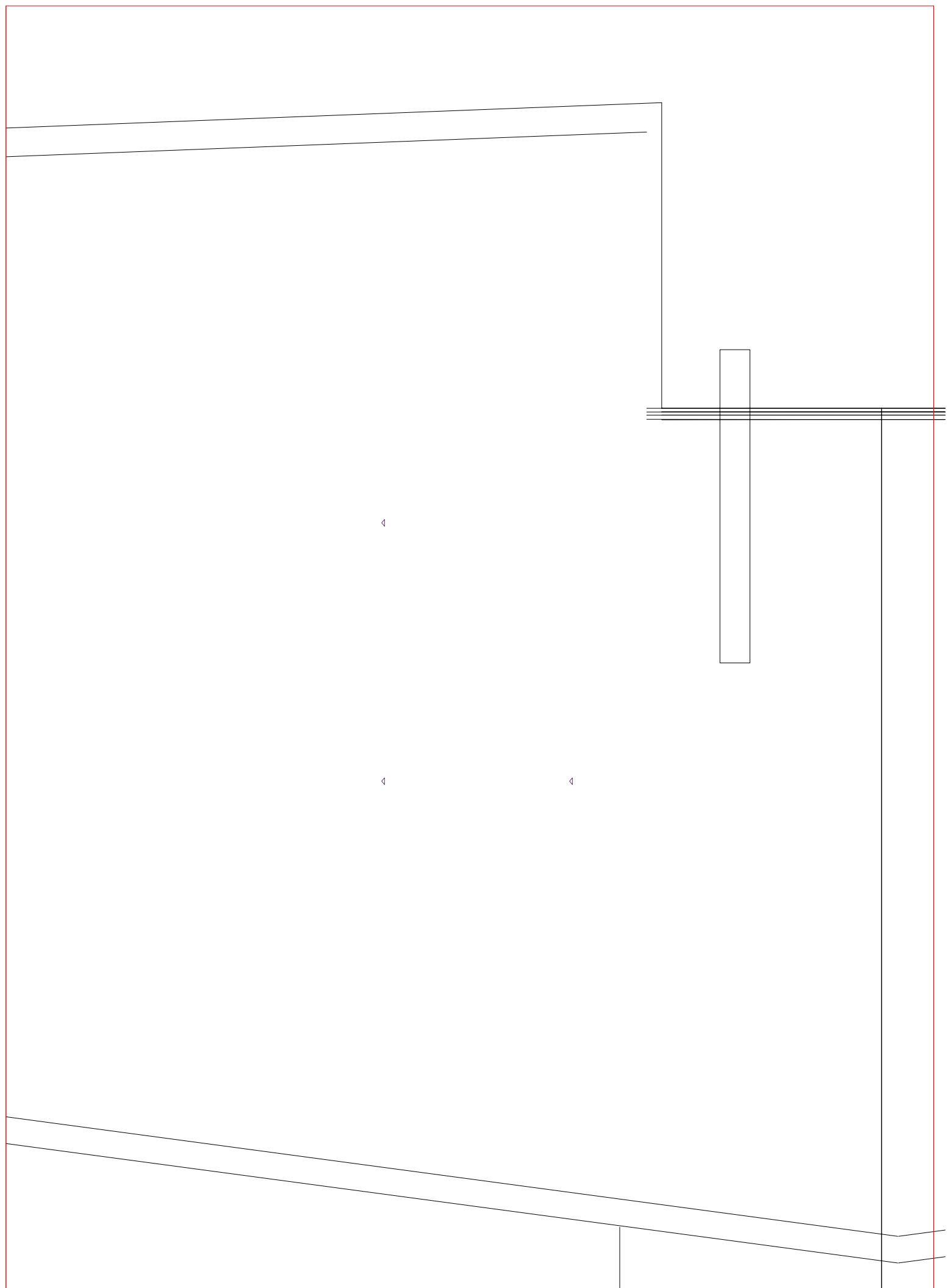



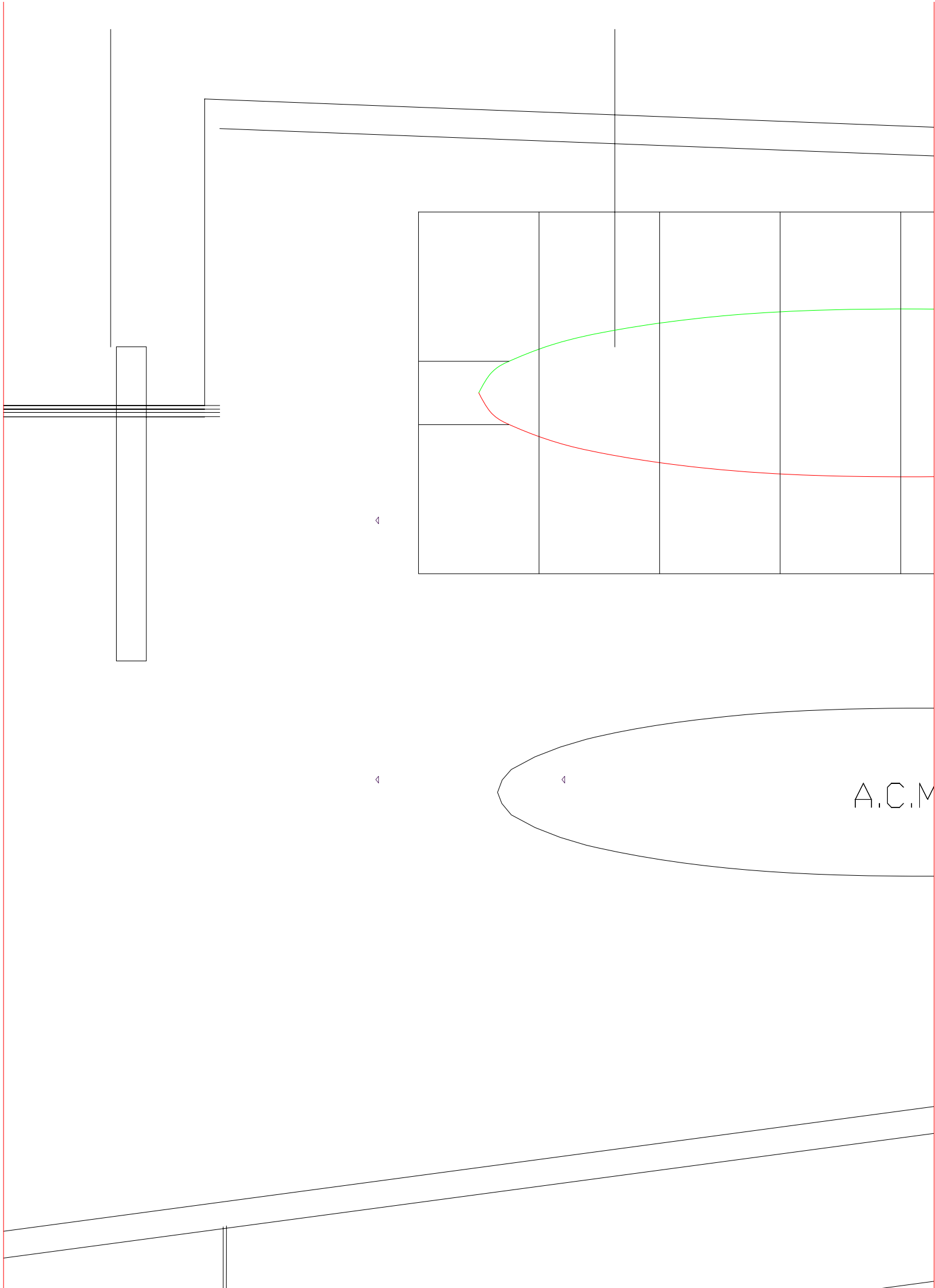

A.C.M.

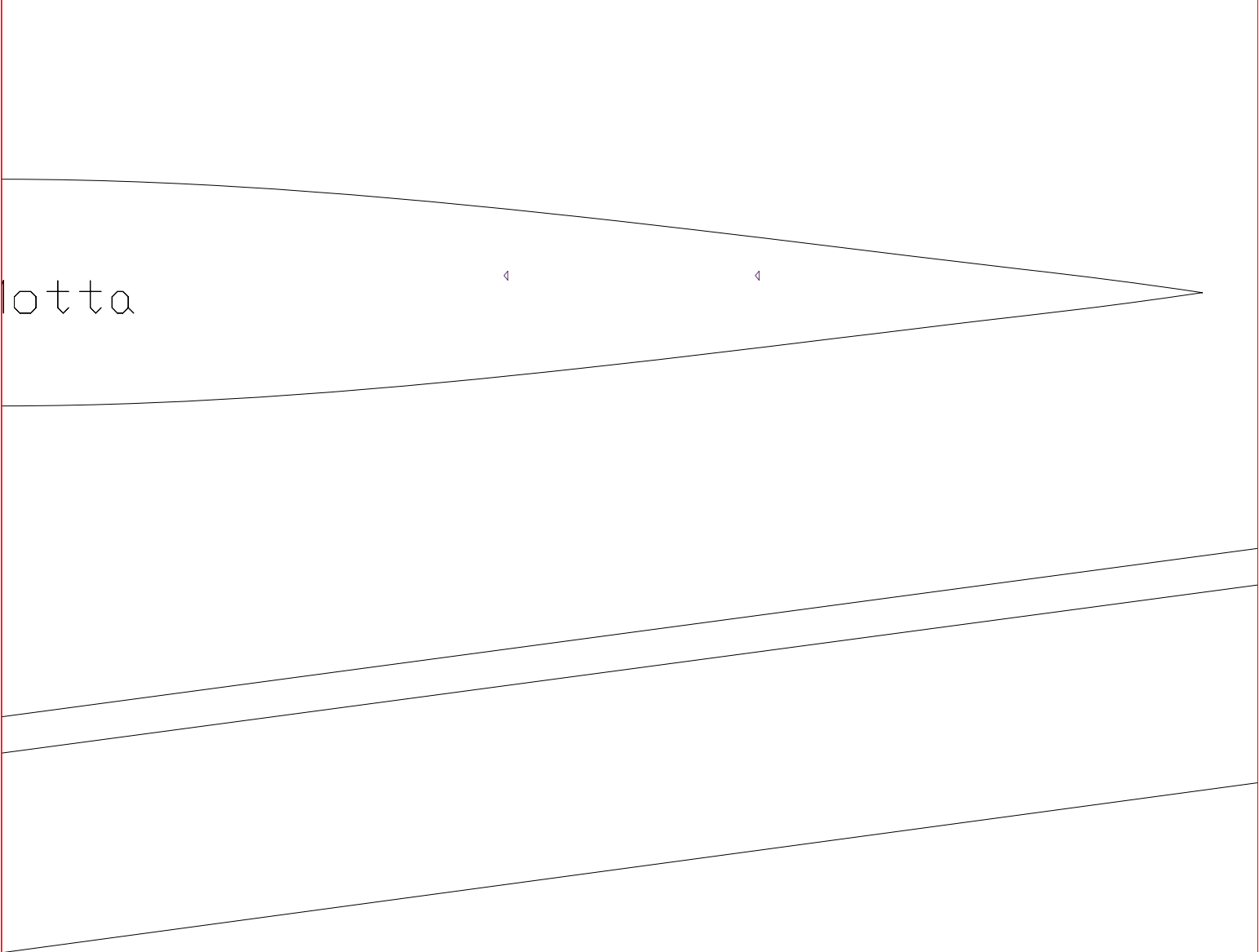
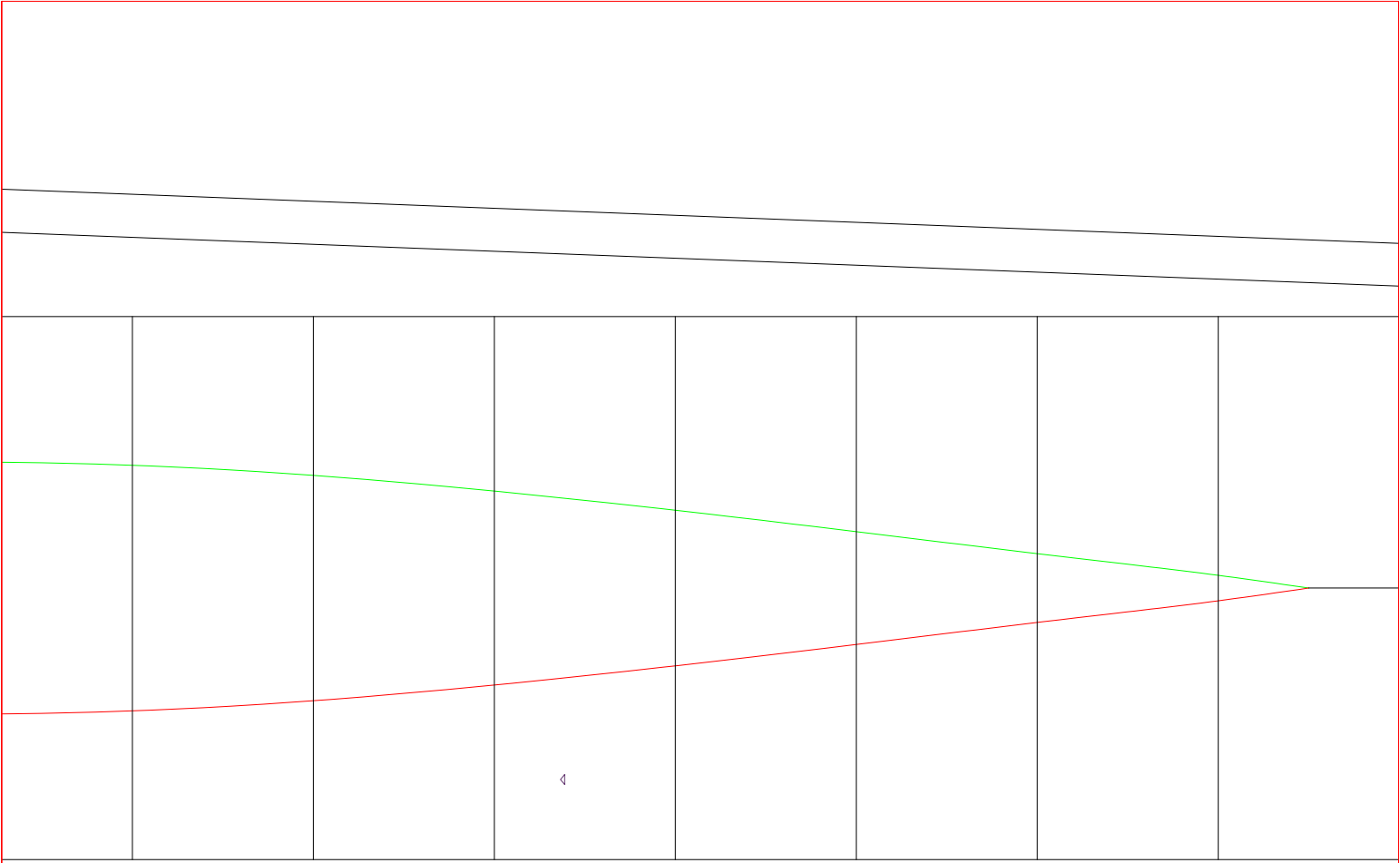

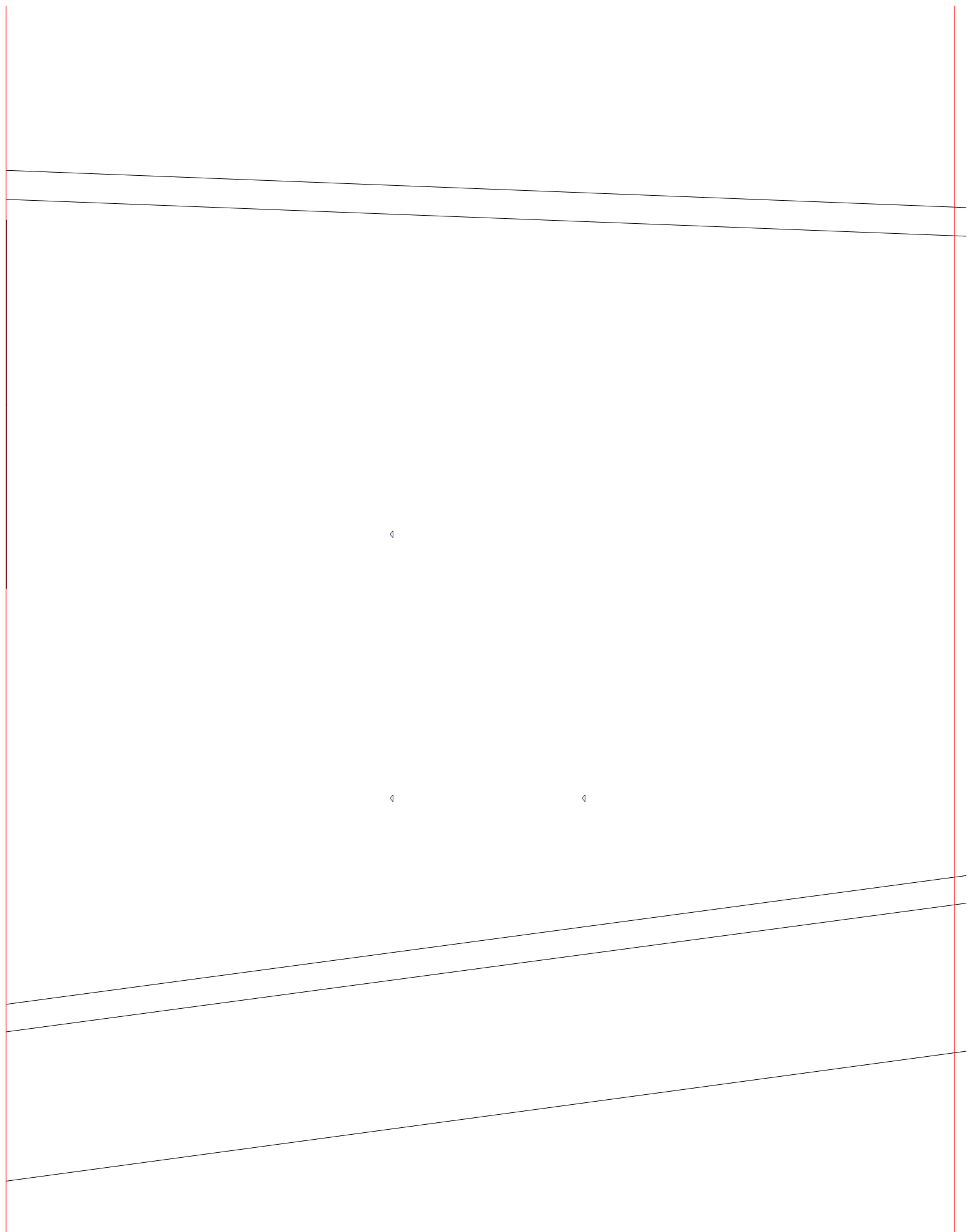



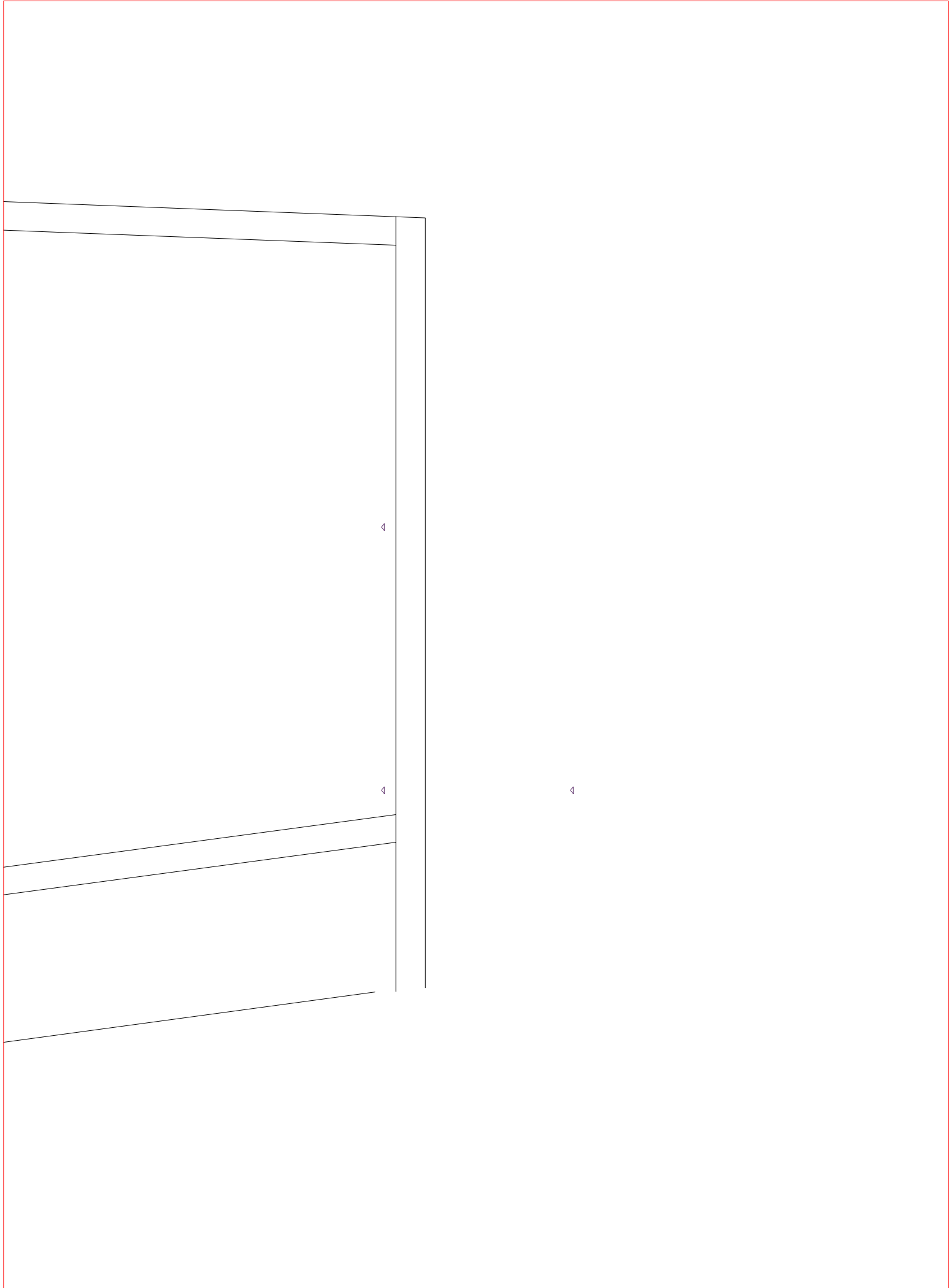

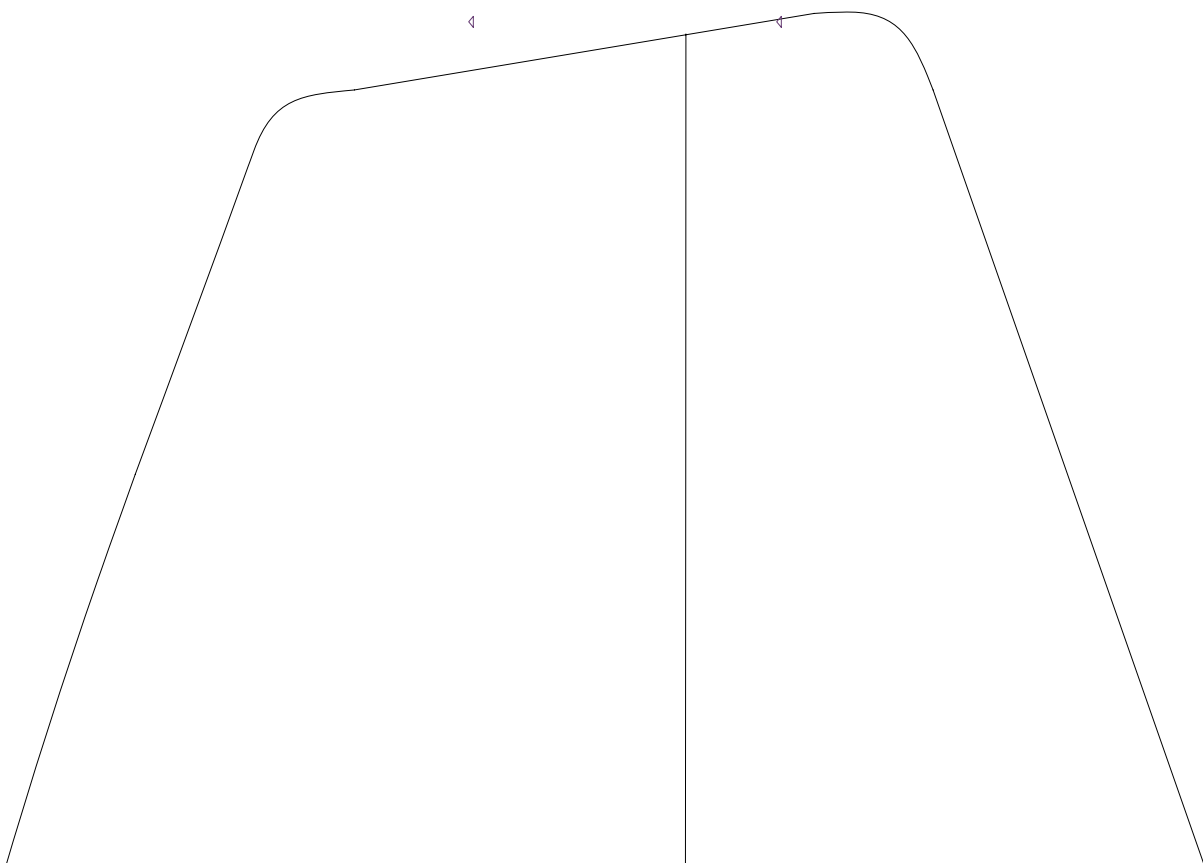
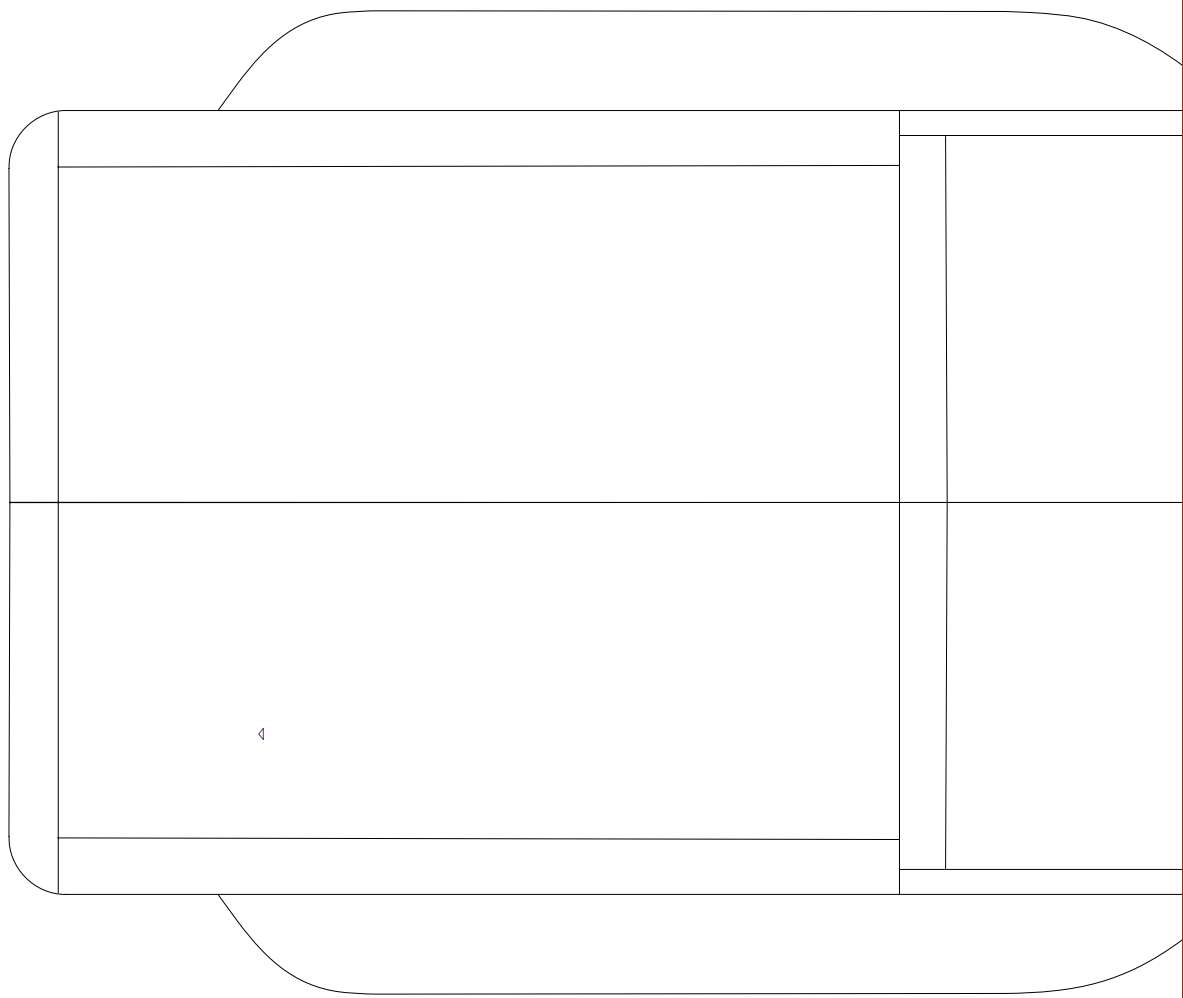

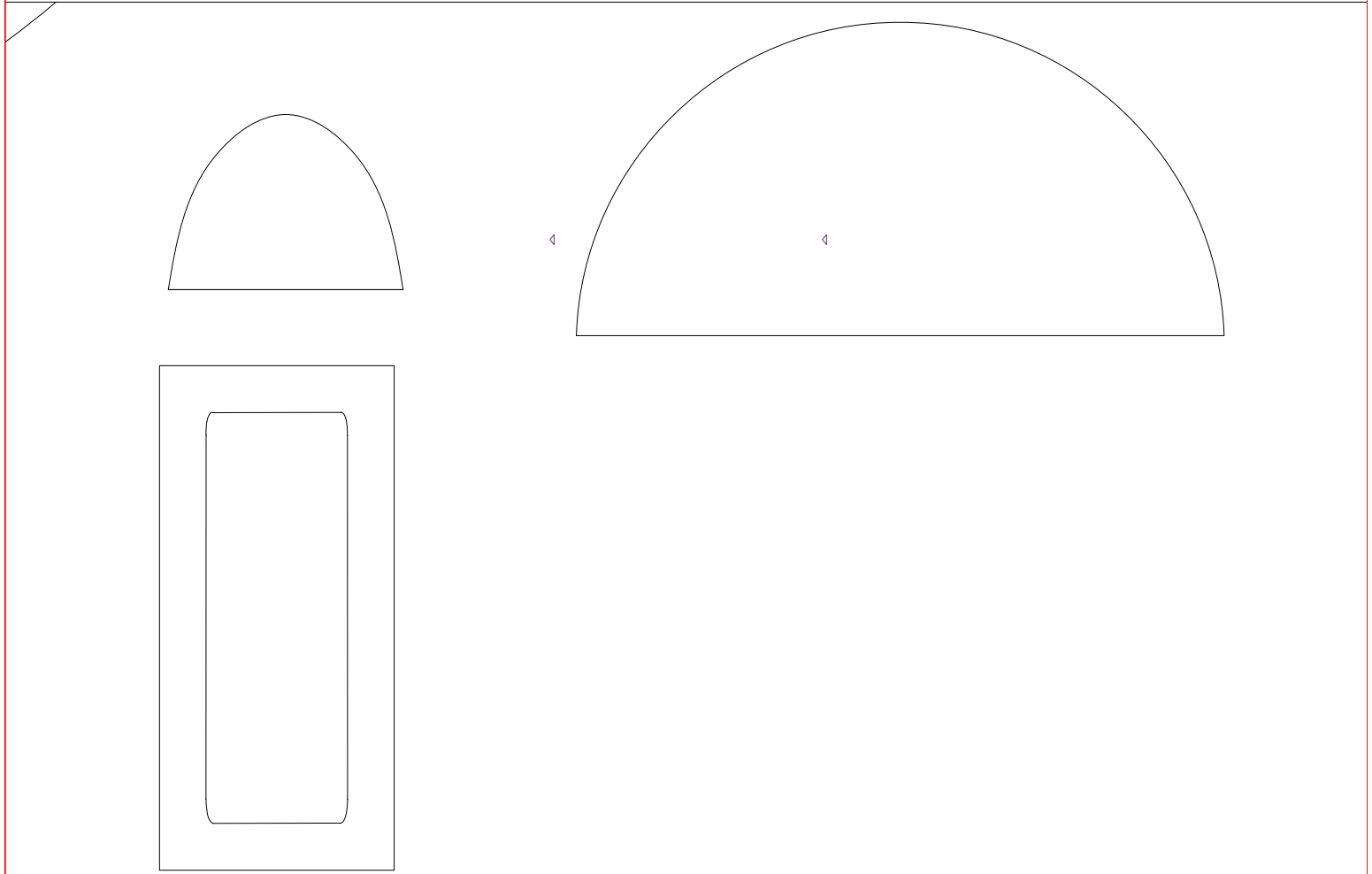

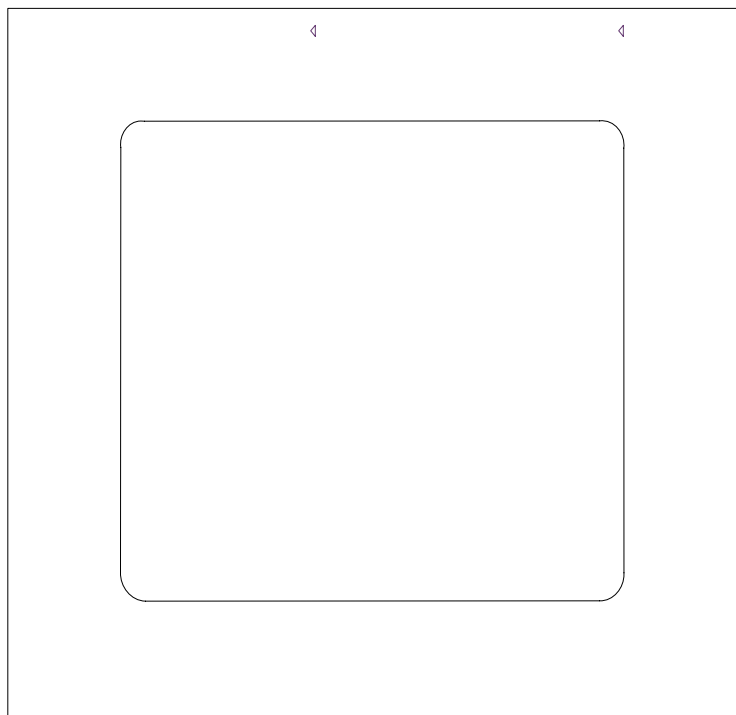
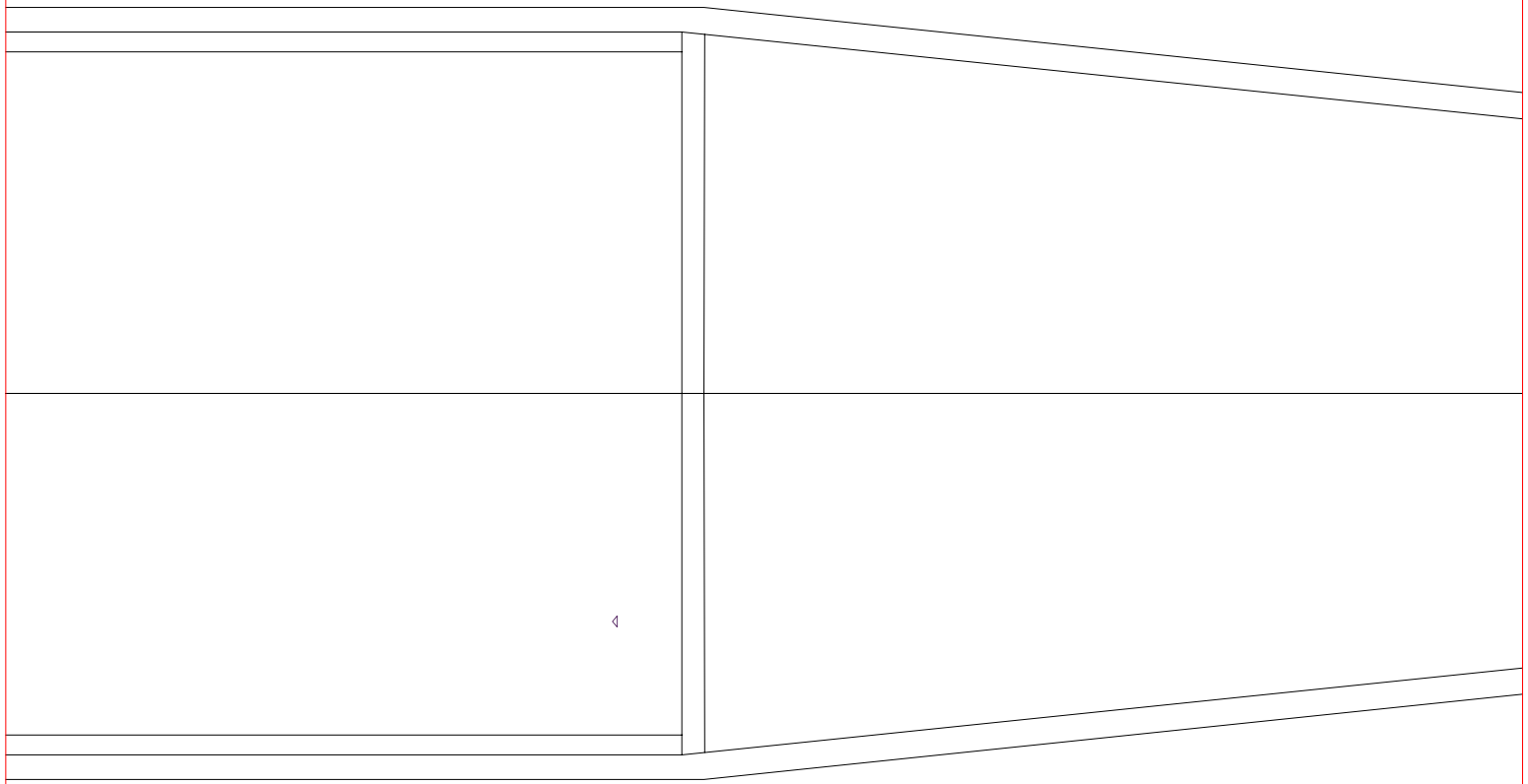

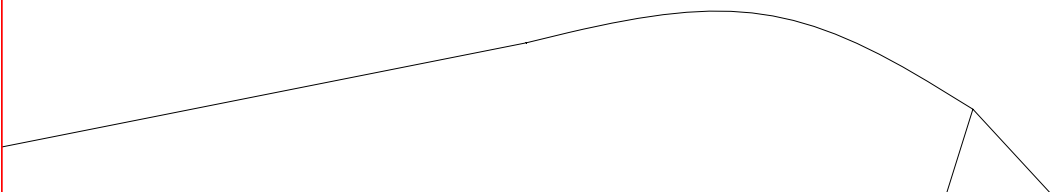
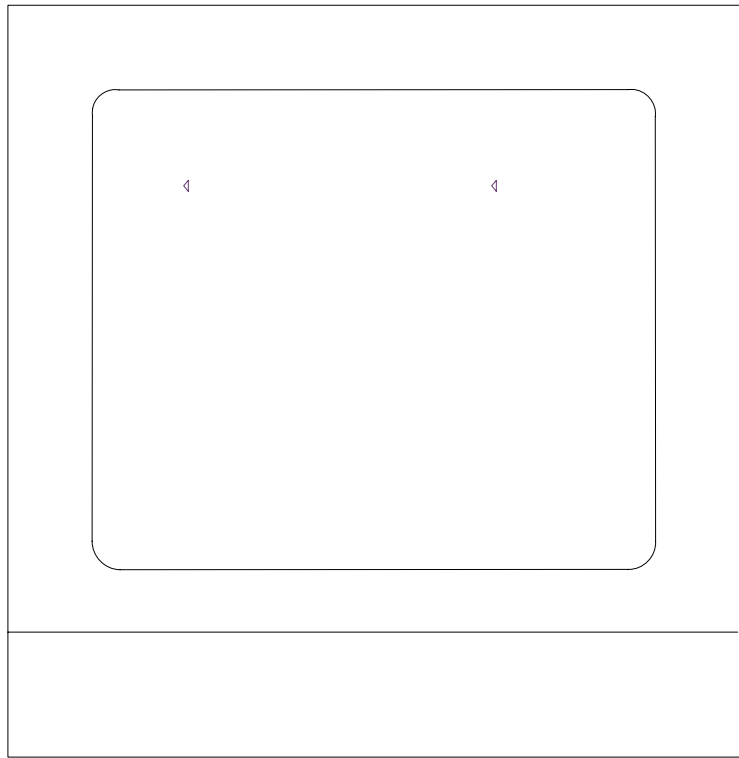
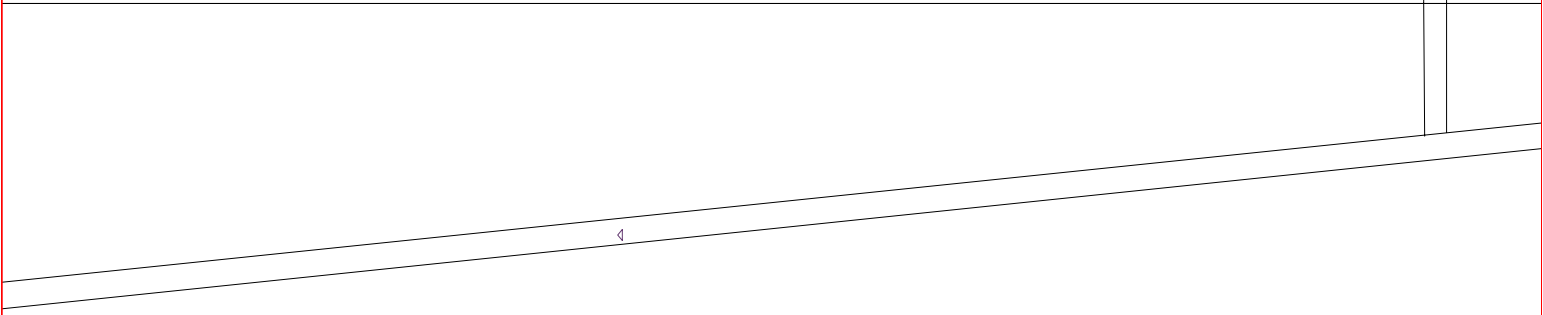
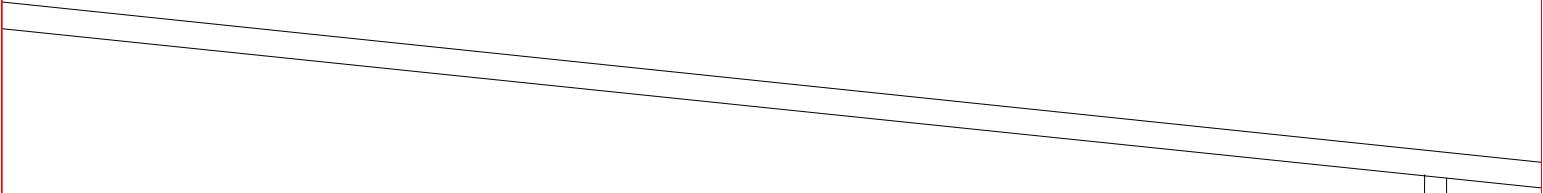
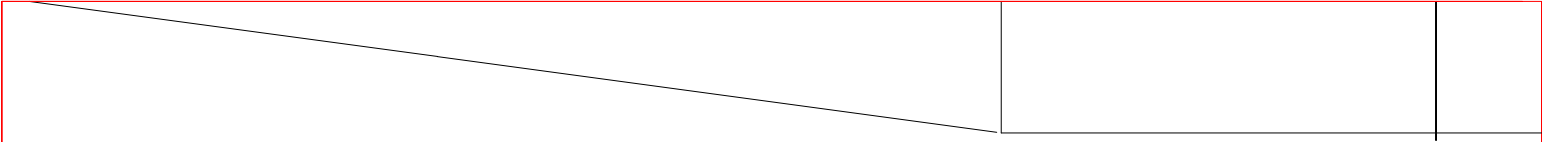

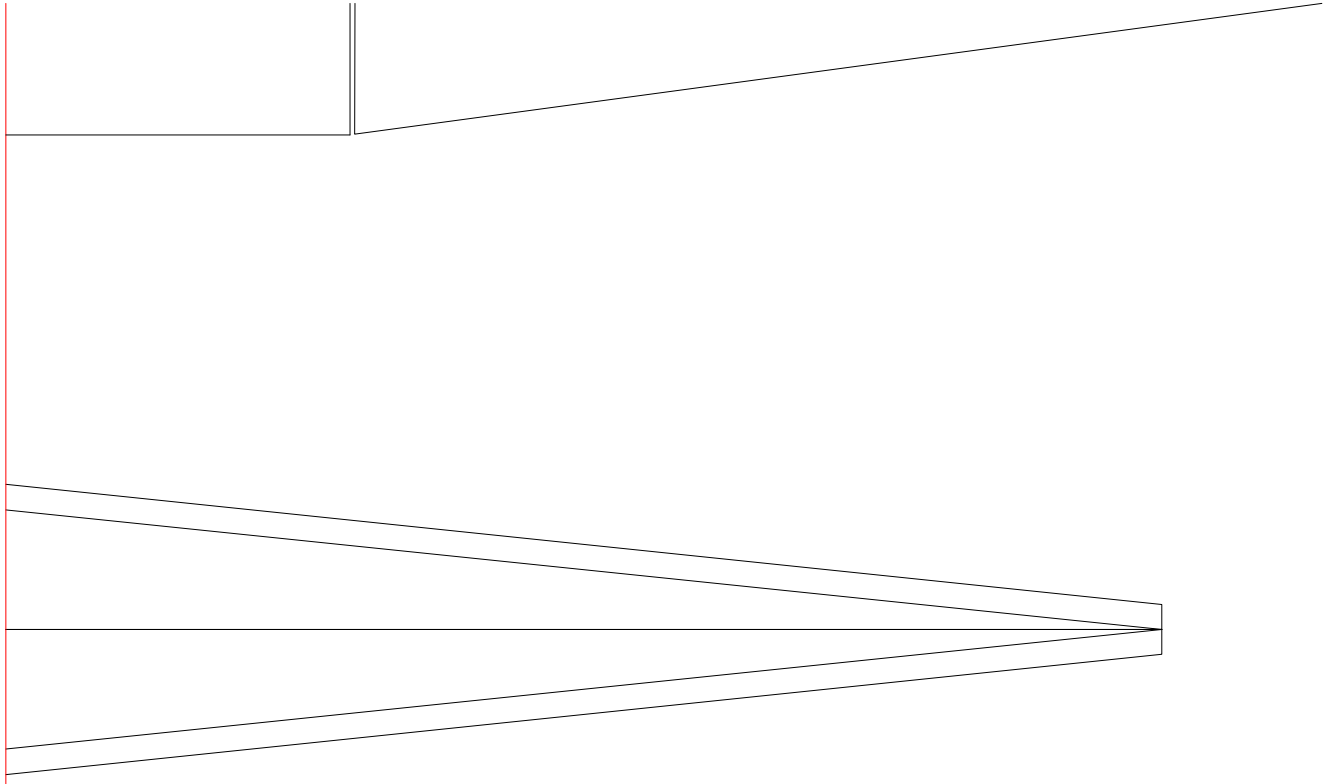

◀

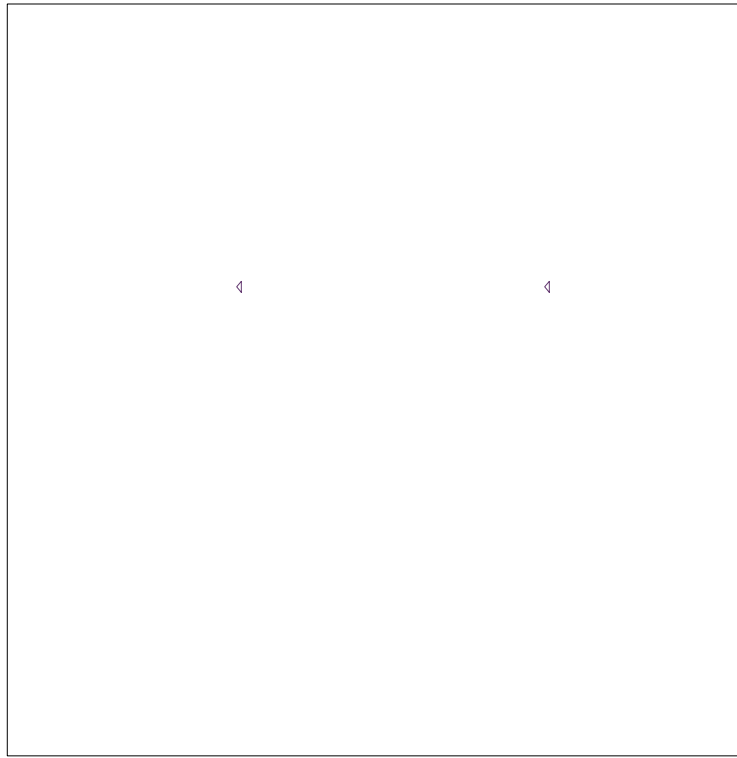

◀

◀

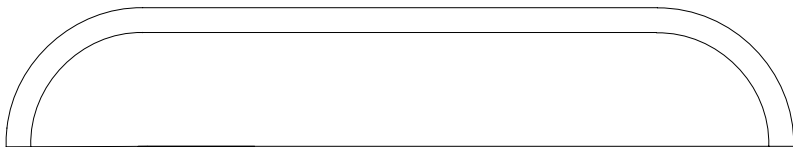

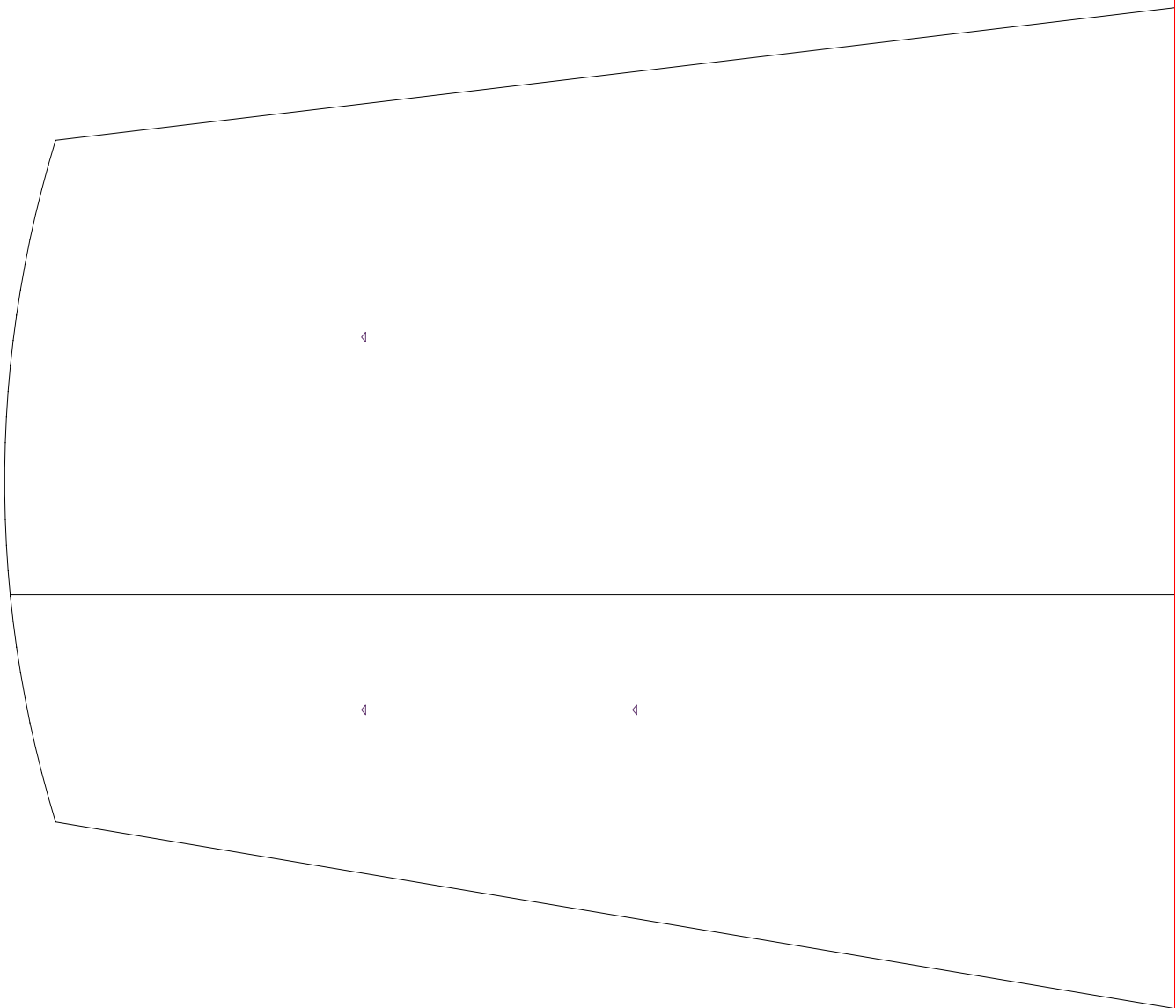

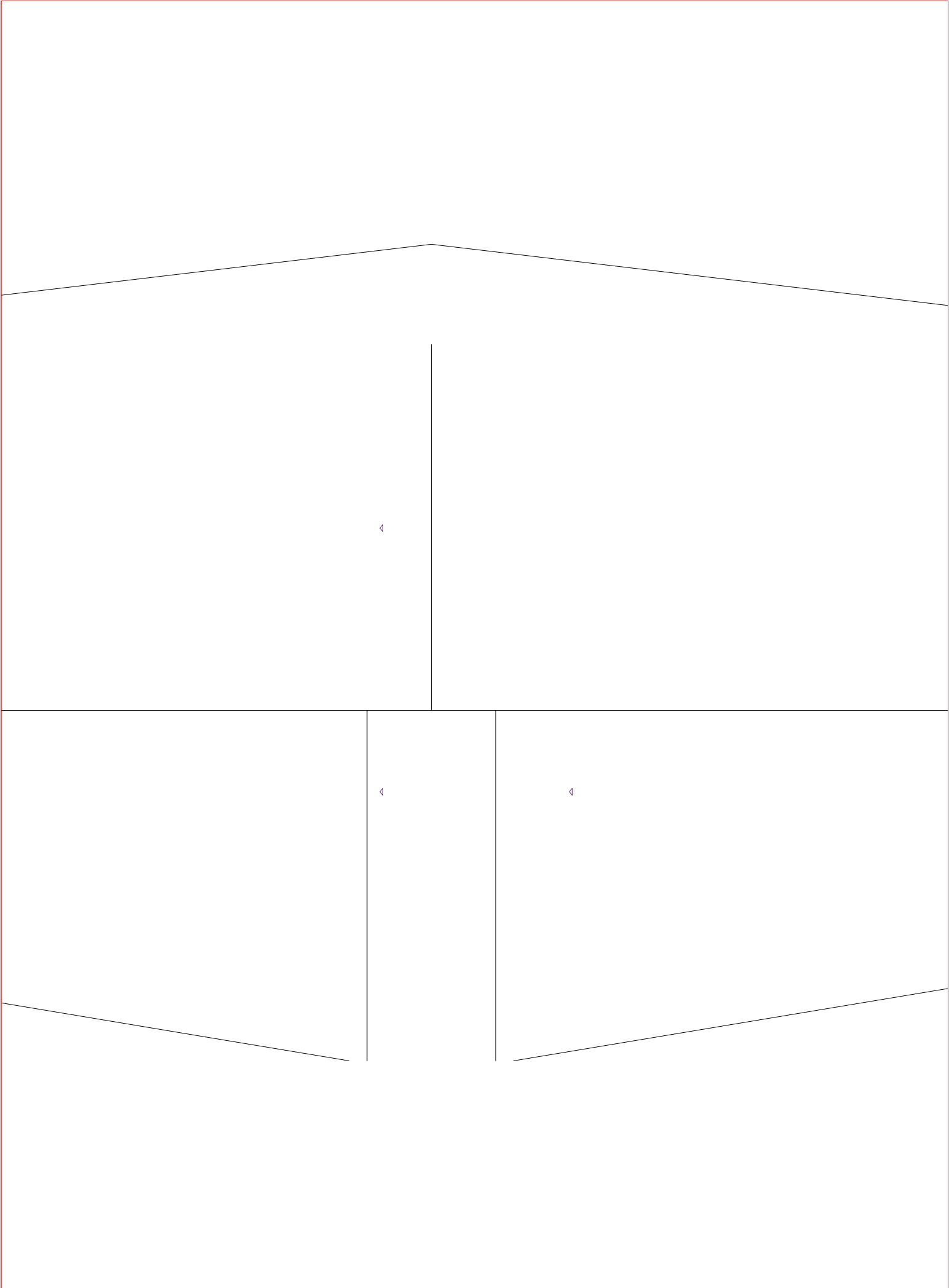



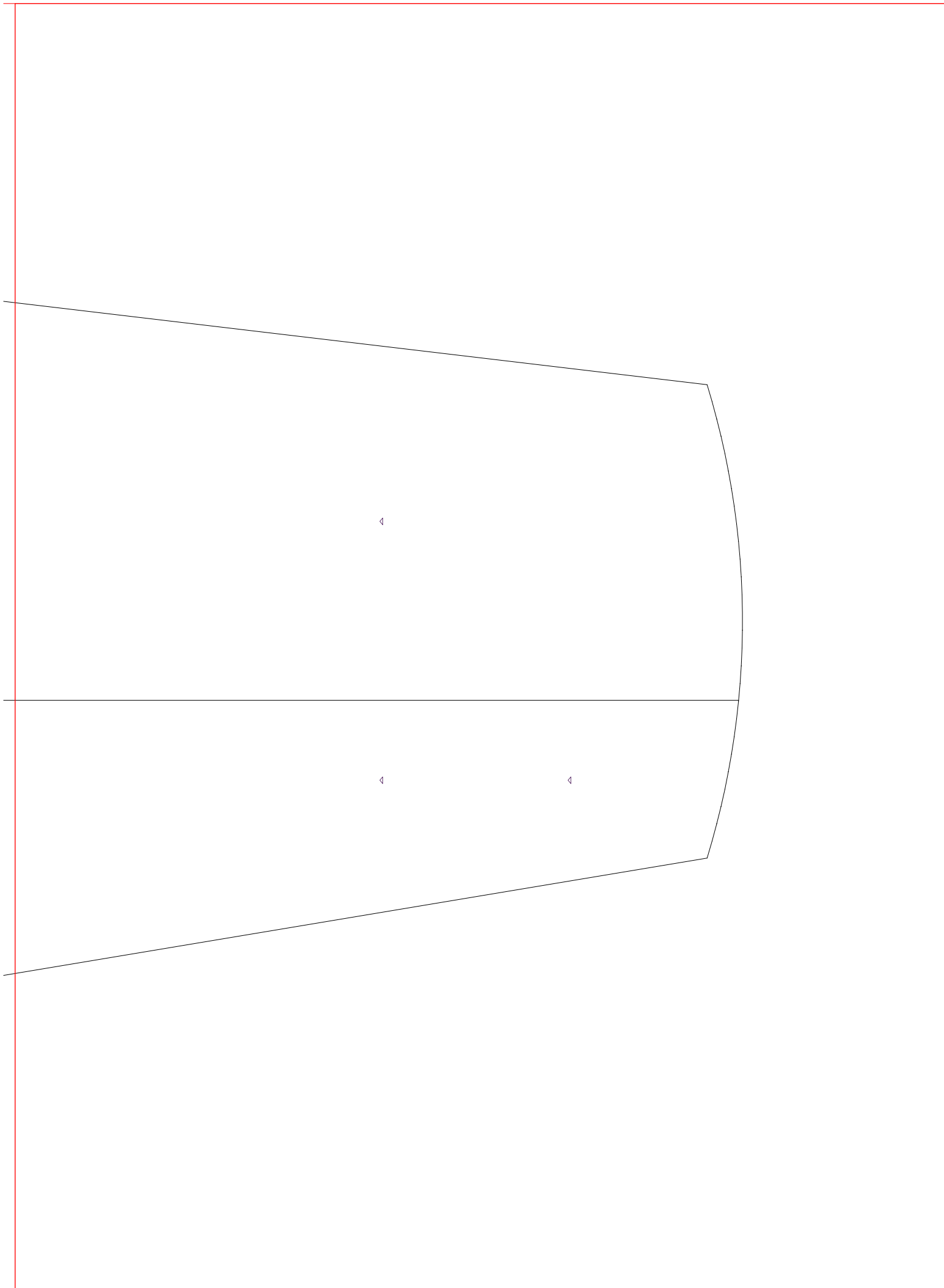

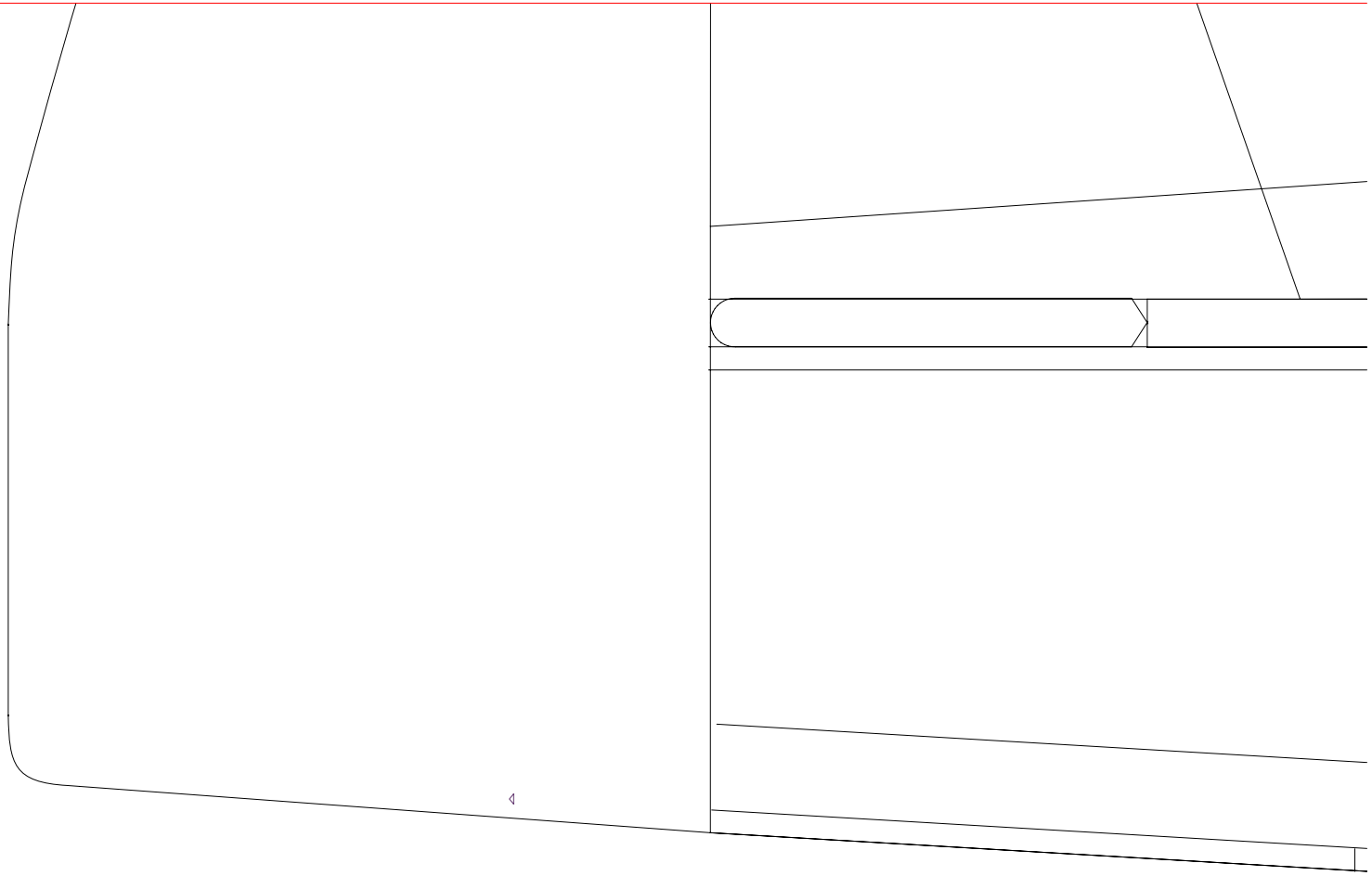

◀

◀

◀

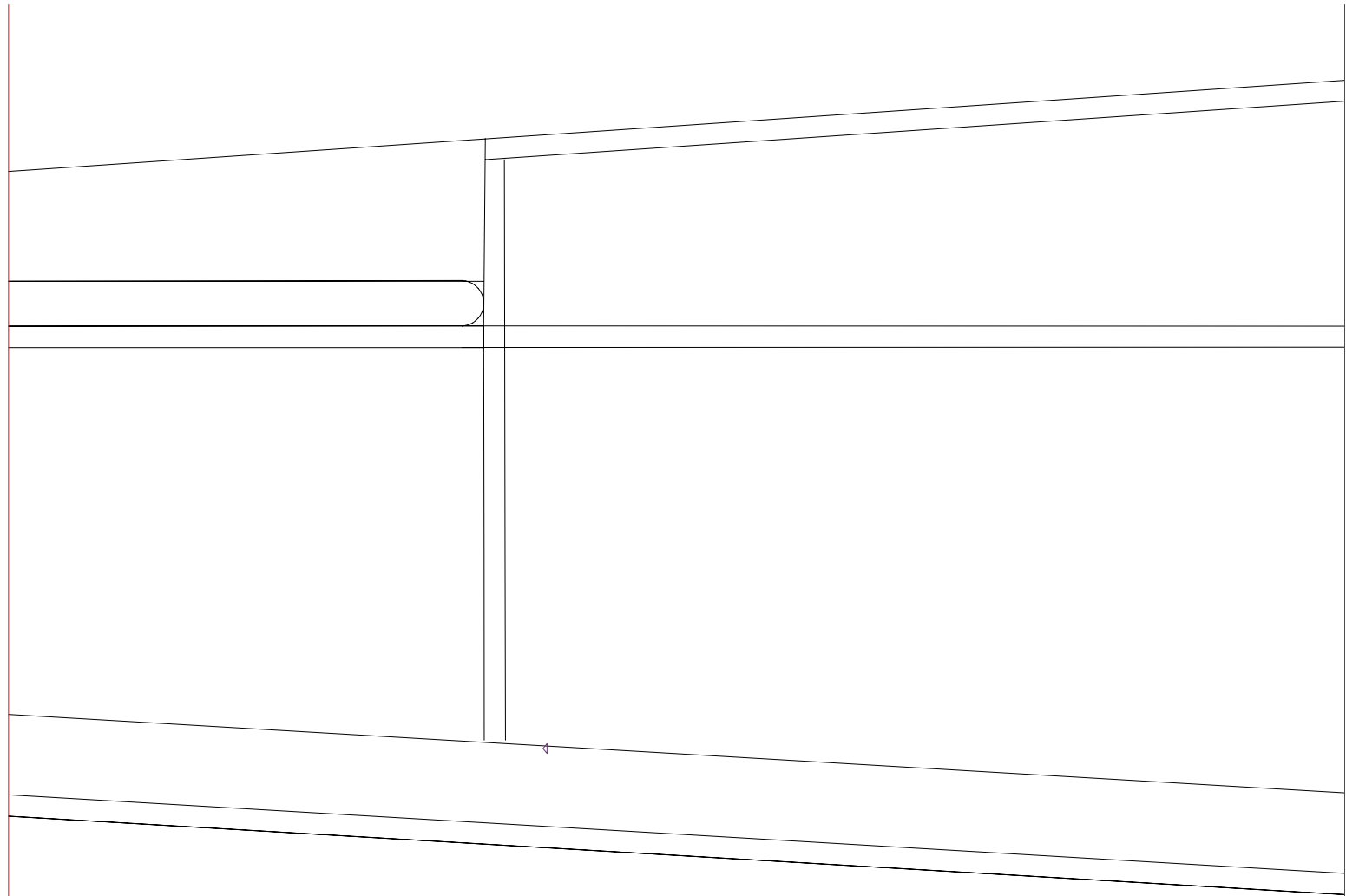

◀

◀

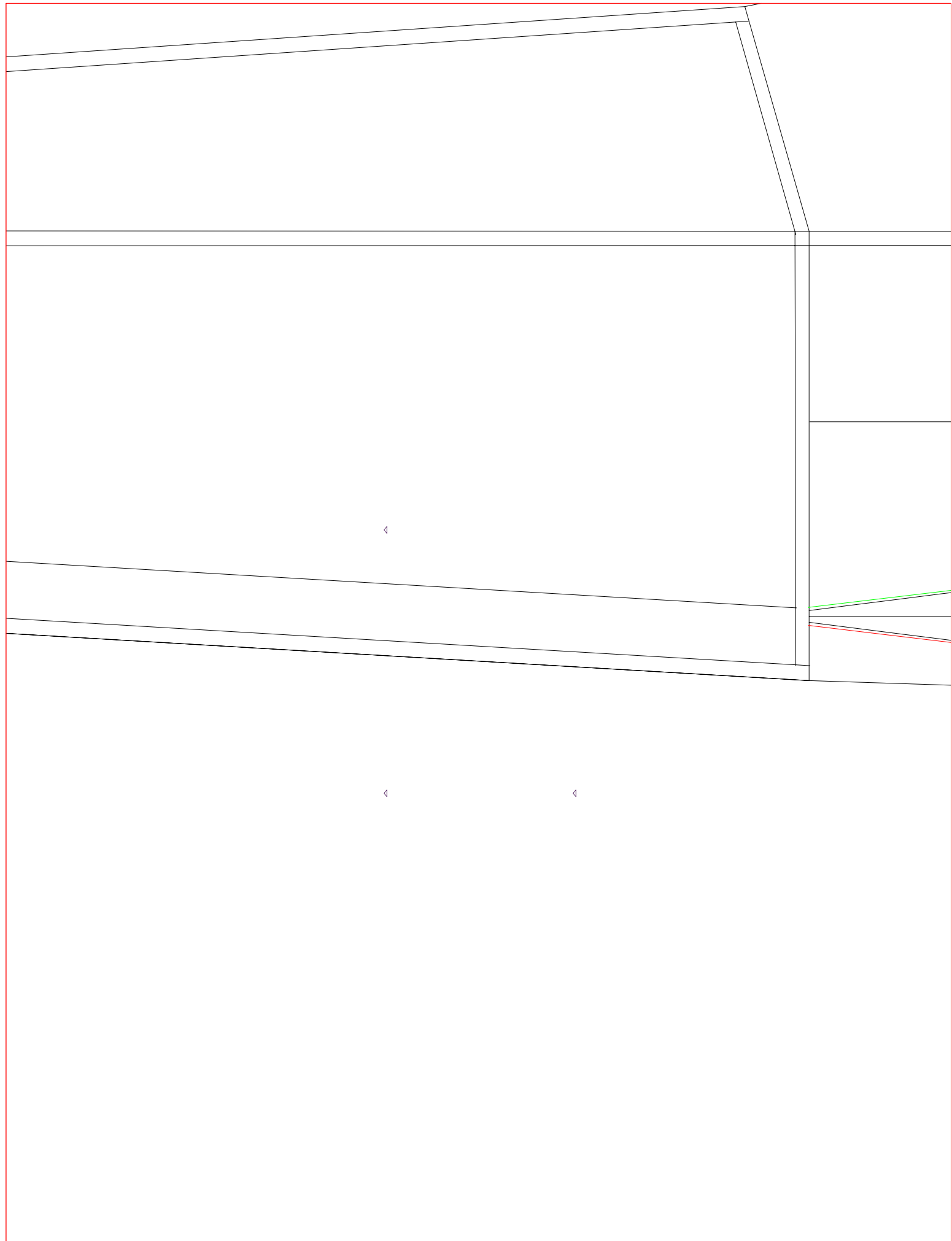

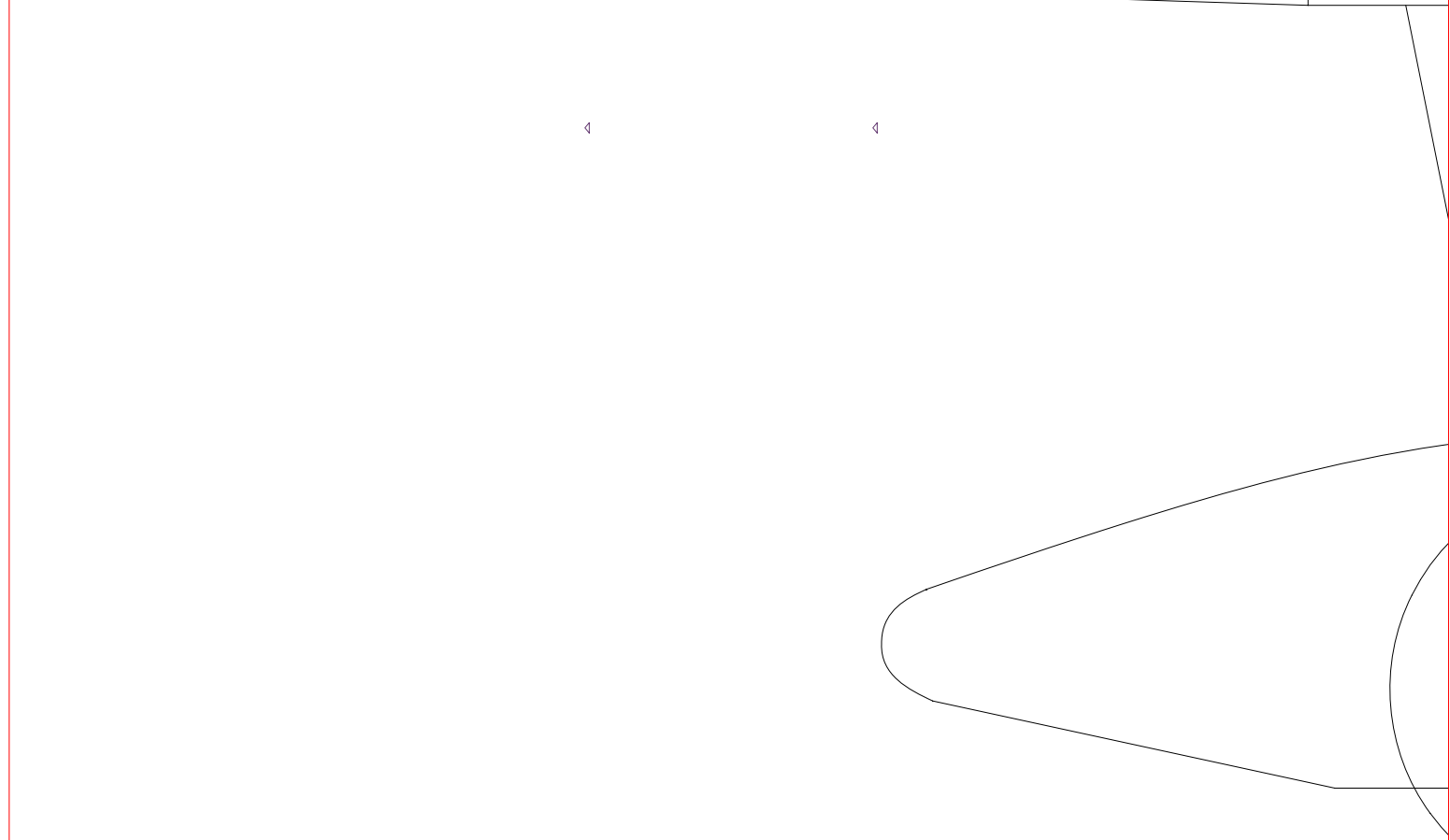
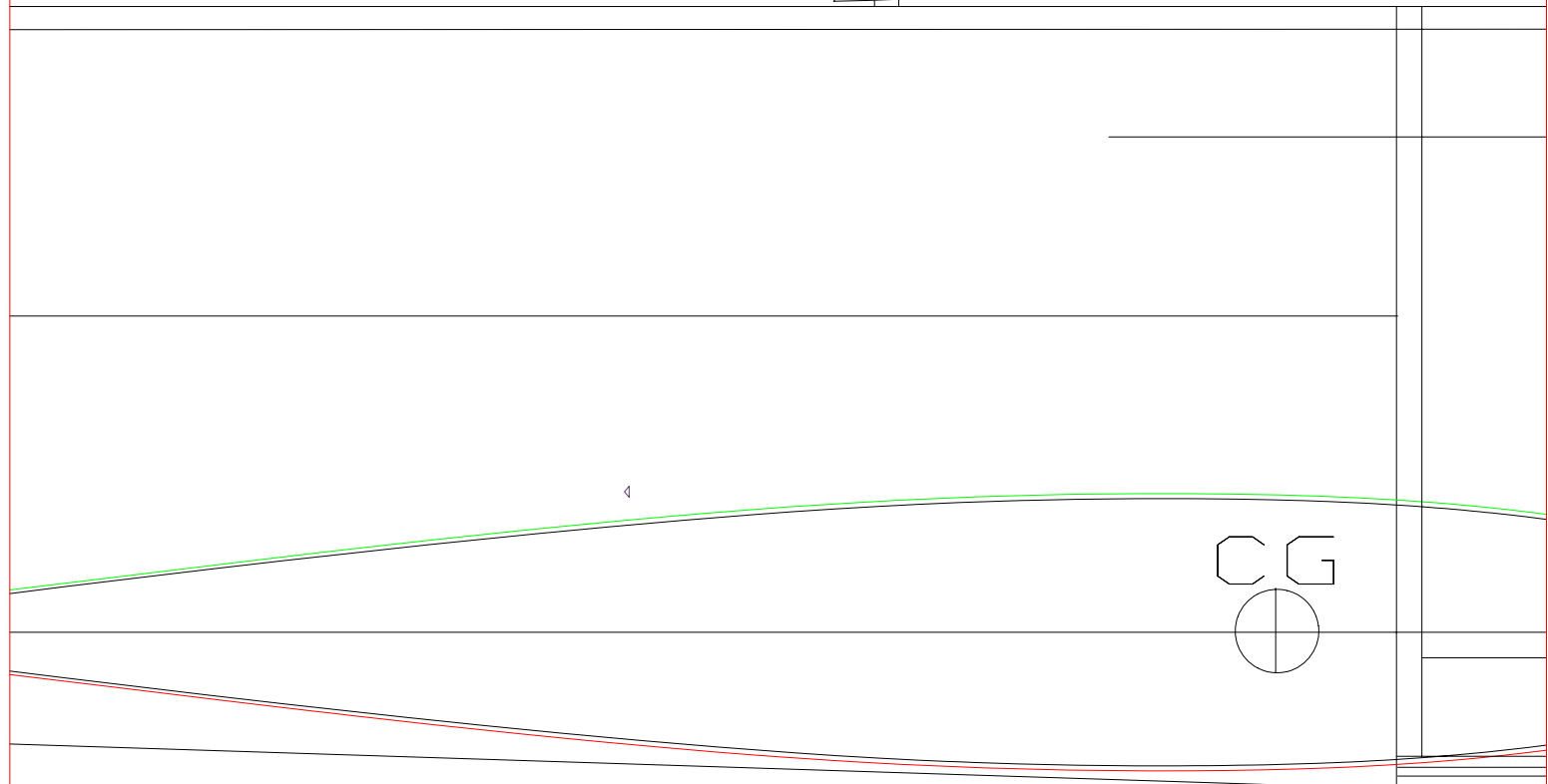
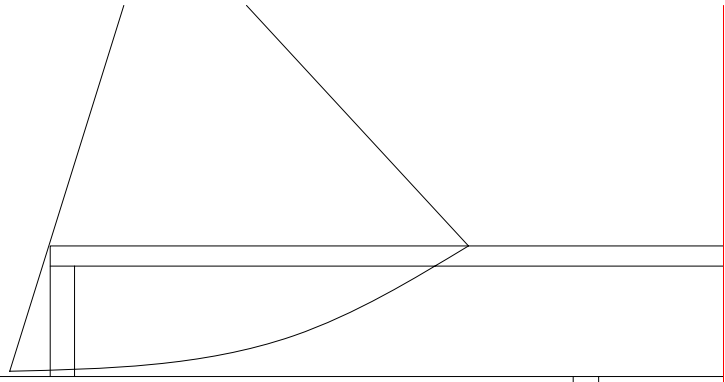

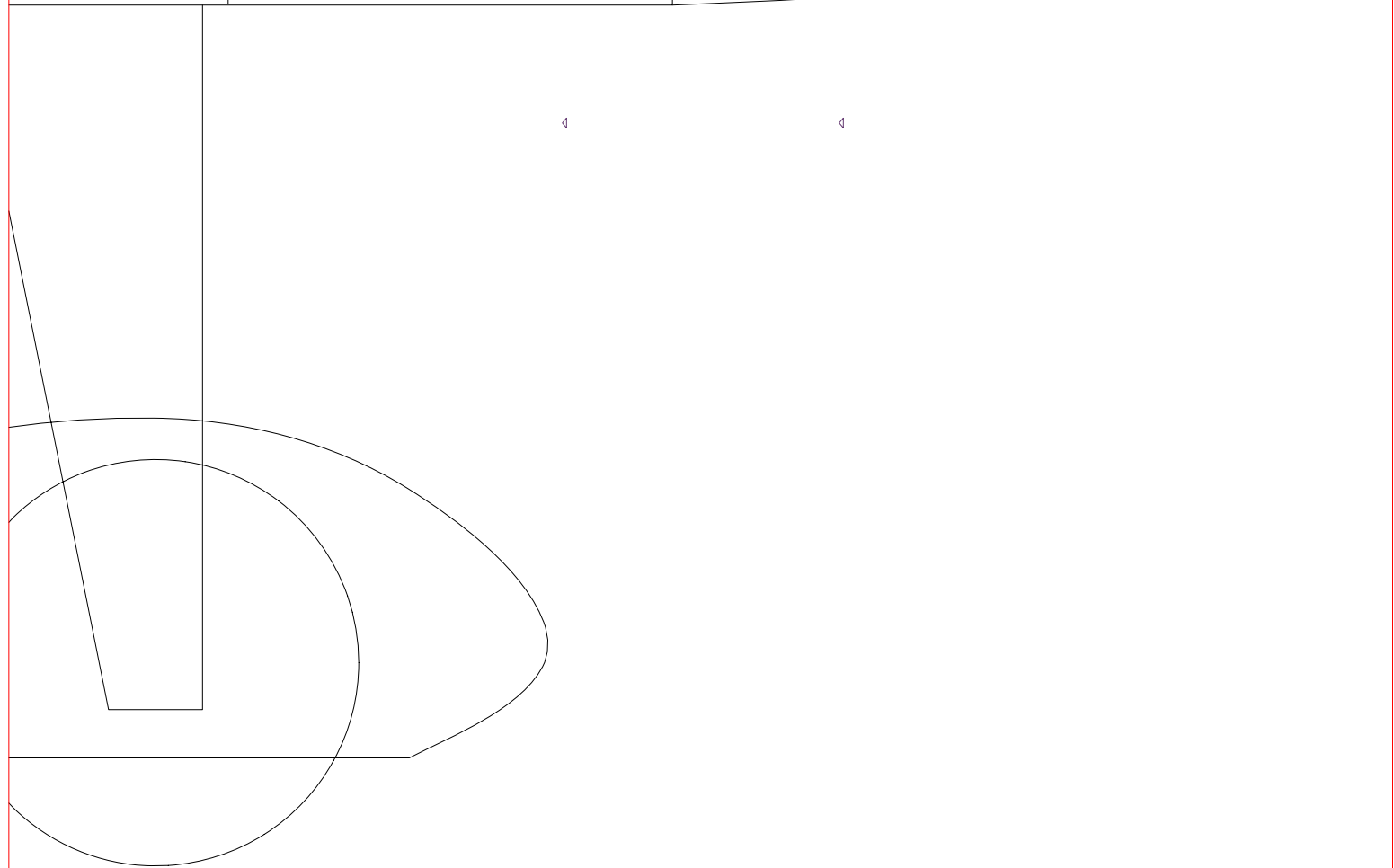
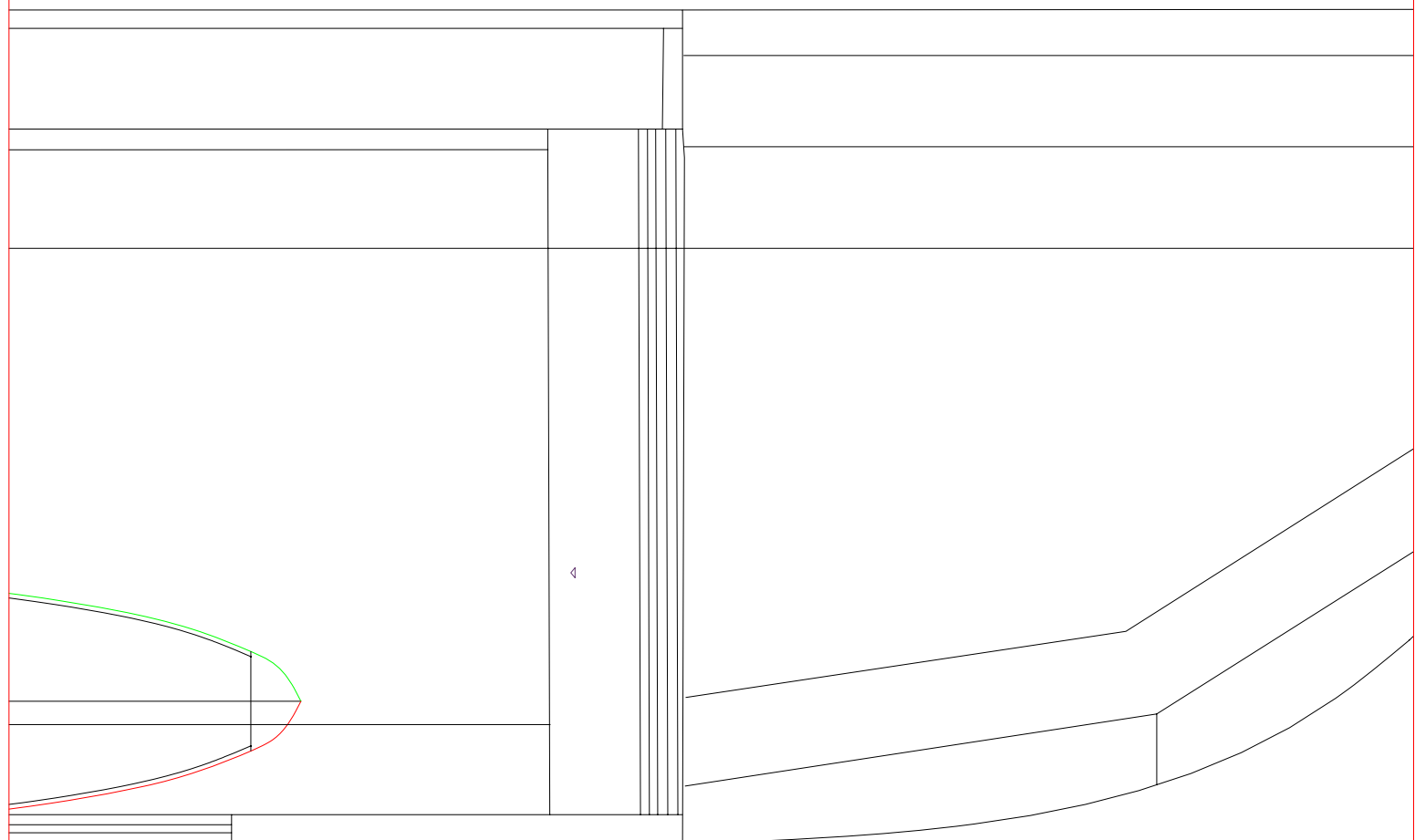

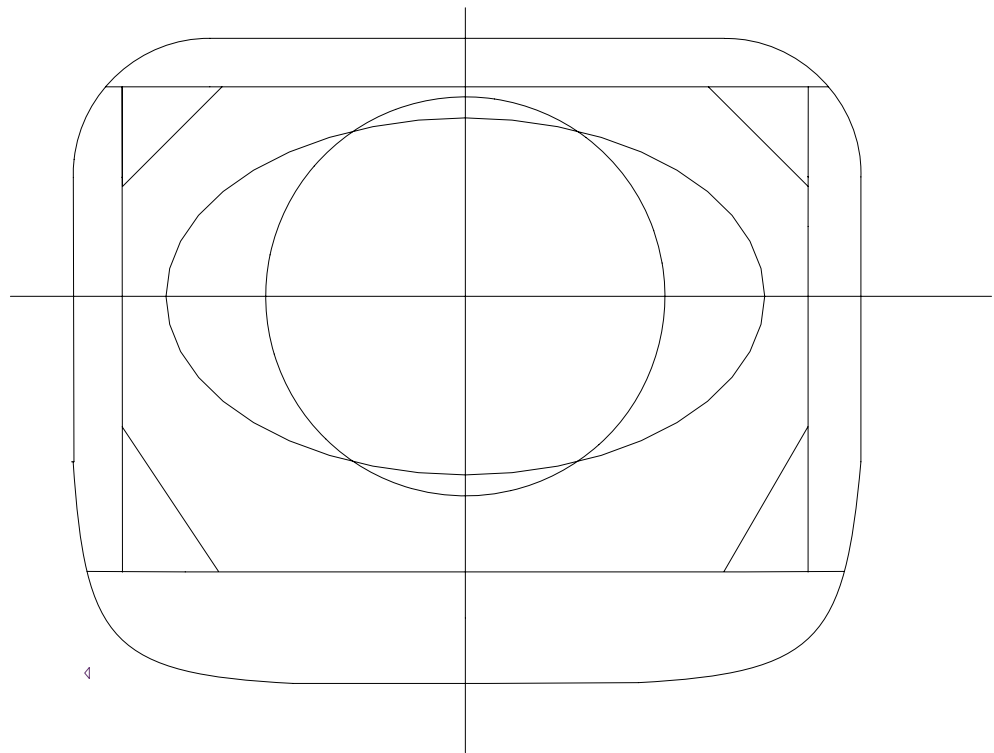
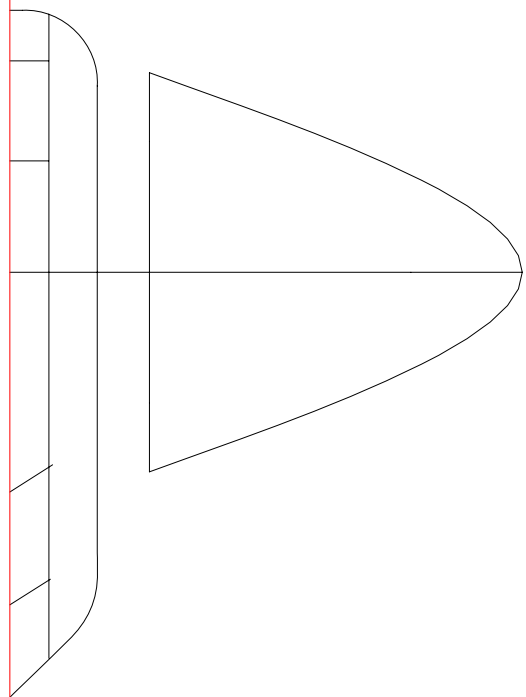

◀

◀

◀

---

CAPPA

Designed by Ca

Envergadura

Trabalho de

e impressão

A.C.Motta



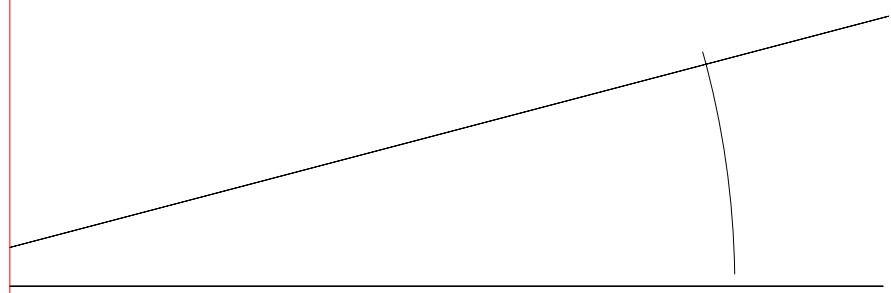

2 inch  
Dihedral

1  
Layden

1400mm

escala